

Thank you for purchasing the EX Module (hereafter referred to as the “this unit”) for the Pro-face’s LT3000 Series. This unit is intended for use with expansion I/O module designed for the LT3000 Series Graphical Logic Controller unit (hereby referred to as “LT”) or with Remote I/O unit (GP3000 Series CANopen board type).  
Before actually beginning to use this product, please be sure to read through this manual and other related manuals to fully understand all the settings and functions.

#### NOTICE

1. Copying this manual’s contents, either in whole or in part, is prohibited without the express permission of Digital Electronics Corporation, Japan.
2. The information contained in this manual is subject to change without notice.
3. If you should you find any errors or omissions in this document, please contact Digital Electronics Corporation to report your findings.
4. Regardless of Clause 3 above, Digital Electronics Corporation shall not be held responsible for any damages, losses or third-party damages resulting from the use of this product.

©2007 Copyright Digital Electronics Corporation. All rights reserved.

Product names used in this manual are the trademarks / registered trademarks of their respective owners.

## 1. Essential Safety Precautions

### DANGER

- An emergency stop circuit and an interlock circuit should be constructed outside of this unit. Constructing these circuits inside this unit may cause a runaway situation, system failure, or an accident due to unit failure.
- Systems using this unit should be designed so that output signals which could cause a serious accident are monitored from outside the unit.
- This unit is designed to be a general-purpose device for general industries, and is neither designed nor produced to be used with equipment or systems in potentially life-threatening conditions. If you are considering using this unit for special uses, including nuclear power control devices, electric power devices, aerospace equipment, medical life support equipment, or transportation vehicles, please contact your local distributor.

### WARNING

- Whenever installing, dismantling, wiring, and conducting maintenance or inspections, be sure to disconnect power to this unit to prevent the possibility of electric shock or fire.
- Do not disassemble or remodel this unit, since it may lead to an electric shock or fire.
- Do not use this unit in an environment that contains flammable gases since an explosion may occur.
- Do not use this unit in an environment that is not specified in the manuals. Otherwise, an electric shock, fire, malfunction or other failure may occur.
- Because of the possibility of an electric shock or malfunction, do not touch any power terminals while the unit is operating.

### CAUTION

- Communication cables or I/O signal lines must be wired separately from the main circuit (high-voltage, large-current) line, high-frequency lines such as inverter lines, and the power line. Otherwise, a malfunction may occur due to noise.
- This unit must be properly installed according to directions in the manuals. Improper installation may cause the unit to malfunction, or fail.
- This unit must be properly wired according to directions in the manuals. Improper wiring may cause a malfunction, failure or electric shock.
- Do not allow foreign substances, including chips, wire pieces, water, or liquids to enter inside this unit's case. Otherwise, a malfunction, failure, electric shock, or fire may occur.
- When disposing of this unit, handle it as an industrial waste.

### ■ To Avoid Damage

- Avoid storing or operating this unit in either direct sunlight or excessively dusty or dirty environments.
- Because this unit is a precision instrument, do not store or use it in locations where excessive shocks or vibration may occur.
- Avoid covering this unit's ventilation holes, or operating it in an environment that may cause it to overheat.
- Avoid operating this unit in locations where sudden temperature changes can cause condensation to form inside the unit.
- Do not use paint thinner or organic solvents to clean this unit.

## ■ About the Relay Output Inductive Load

### ◆ Protecting Outputs from Inductive Load Damage

Depending on the load, a protection circuit may be needed for the outputs on the controllers and certain modules. Inductive loads using DC voltages may create voltage reflections resulting in overshoot that will damage or shorten the life of output devices.

## ⚠ CAUTION

### OUTPUT CIRCUIT DAMAGE DUE TO INDUCTIVE LOADS

- Use an appropriate external protective circuit or device to reduce the risk of inductive direct current load damage.

Failure to follow these instructions can result in injury or equipment damage.

Relay outputs can support up to 240 Vac. Inductive damage to these types of outputs can result in welded contacts and loss of control. Each inductive load must be equipped with a protection device such as a peak limiter, RC circuit or flyback diode. Capacitive loads are not supported by these relays.

## ⚠ WARNING

### RELAY OUTPUTS WELDED CLOSED

- Always protect relay outputs from inductive alternating current load damage using an appropriate external protective circuit or device.
- Do not connect relay outputs to capacitive loads.

Failure to follow these instructions can result in death, serious injury, or equipment damage.

Protective circuit A: this protection circuit can be used for both AC and DC load power circuits.

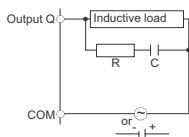

Protective circuit B: this protection circuit can be used for DC load power circuits.

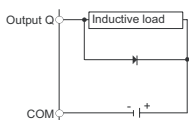

Use a diode with the following ratings:

- Reverse withstand voltage: power voltage of the load circuit x 10.
- Forward current: more than the load current.

Protective circuit C: this protection circuit can be used for both AC and DC load power circuits.

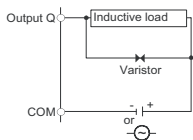

#### NOTE

- The above schematics show sinking DC outputs, but would apply equally to source outputs.

## 2. Package Contents

- (1) Inquiry/UL/c-UL Approval (1)
- (2) EX Module Unit (1)
- (3) Terminal Connector

A connector for EX modules except EXM-DDO16UK/EXM-DDO16TK/EXM-DMM24DRF.

For the details about number of pieces and pins, please see I/O Specifications of each module. (Chapter 15)



- (4) Terminal Block (nonremoval) (2)  
(EXM-DMM24DRF)
- (5) Power Supply Screw Terminal Block (1)  
(EXM-ARI8LT)

\*MIL Connector is not packed with EX Module Unit.  
(EXM-DDO16UK/EXM-DDO16TK)

This unit has been carefully packed, with special attention to quality. However, should you find anything damaged or missing, please contact your Pro-face local distributor immediately.

## 3. Supported Models and Software

### ■ Supported models

- LT3000 Series
- Hybrid Terminal Block (HTB)\*1

\*1 Hybrid Terminal Block (HTB)-compatible and CANopen-compatible connectors and cables are necessary for the connection to the GP3000 Series CANopen board type. For details, refer to the GP3000 Series Hardware Manual and the Hybrid Terminal Block Hardware Manual.

### ■ Supported Software Version, GP-Pro EX

An LT/GP with a project file, see table for lowest version, should be used. (Version of transfer tool should be identical.)

	LT3000 Series		GP3000 Series CANopen board type connecting HTB
	LT-3200 Series	LT-3300 Series	
EXM-DMM24DRF	Ver.2.6	Ver.2.6	Ver.2.61
EXM-AMI4LT			
EXM-ARI8LT			
EXM-AVO2HT			
EXM-AMM6HT			
EX Module (Except for the five models listed above)	Ver.2.0	Ver.2.1	Ver.2.1

## 4. EX Modules Model Names

### ■ Standard Input Module

Product Name	Model No.	Description
EX Module (8-point input module)	EXM-DDI8DT	8-point sink/source shared I/O Unit. 24VDC input signal can be connected.
EX Module (16-point input module)	EXM-DDI16DT	16-point sink/source shared I/O Unit. 24VDC input signal can be connected.

### ■ Standard Output Module

Product Name	Model No.	Description
EX Module (8-point relay-output module)	EXM-DRA8RT	8-point relay output/2 common type I/O Unit.
EX Module (16-point relay-output module)	EXM-DRA16RT	16-point relay output/2 common type I/O Unit.
EX Module (8-point sink-output module)	EXM-DDO8UT	8-point transistor output sink I/O Unit.
EX Module (8-point source-output module)	EXM-DDO8TT	8-point transistor output source I/O Unit.
EX Module (16-point sink-output module)	EXM-DDO16UK	16-point transistor output sink I/O Unit.
EX Module (16-point source-output module)	EXM-DDO16TK	16-point transistor output source I/O Unit.

### ■ Standard I/O Module

Product Name	Model No.	Description
EX Module (4-point inputs/4- point relay-output module)	EXM- DMM8DRT	4-point input sink-source/4-point relay-output/1 common type I/O Unit.
EX module (16-point inputs/8- point relay-output module)	EXM- DMM24DRF	16-point input sink-source/8-point relay-output/1 common type I/O Unit.

### ■ Analog Input Module

Product Name	Model No.	Description
EX Module (2-ch analog-input module)	EXM-AMI2HT	2-ch analog Input Unit. (Voltage DC0 to 10V / Current DC4 to 20mA)
EX module (4-ch Analog input / Temperature input module)	EXM-AMI4LT	4-ch temperature Input Unit. (Voltage DC0 to 10V / Current DC0 to 20mA) Pt100/Pt1000/Ni100/Ni1000
EX module (8-ch Pt100/Pt1000 input module)	EXM-ARI8LT	8-ch temperature Input Unit. Pt100/Pt1000

## ■ Analog Output Module

Product Name	Model No.	Description
EX Module (1-ch analog-output module)	EXM-AMO1HT	1-ch analog Output Unit. (Voltage DC0 to 10V / Current DC4 to 20mA)
EX module (2-ch analog-output module)	EXM-AVO2HT	2-ch analog Output Unit. (Voltage DC-10 to +10V )

## ■ Analog I/O Module

Product Name	Model No.	Description
EX Module (Thermocouple Pt100 input/1-ch analog-output module)	EXM-ALM3LT	2-ch temperature Input/1-ch analog Output Unit. Pt100 Input (Voltage Output DC0 to 10V / Current Output DC4 to 20mA)
EX Module (2-ch analog-input/1-ch analog-output module)	EXM-AMM3HT	2-ch analog Input/1-ch analog Output Unit. (Voltage I/O DC0 to 10V / Current I/O DC4 to 20mA)
EX module (4-ch analog-input/2-ch analog-output module)	EXM-AMM6HT	4-ch analog Input/2-ch analog Output Unit. (Voltage I/O DC0 to 10V / Current I/O DC4 to 20mA)

## 5. About the Manual

For detailed information on this unit for the LT3000 and other series, refer to Pro-face's PDF manuals such as follows:

- LT3000 Series Hardware Manual
- GP3000 Series Hardware Manual
- GP-Pro EX Reference Manual "Controlling External I/O"
- Maintenance/Troubleshooting

The manuals can be selected from the help menu of GP-Pro EX or downloaded from Pro-face Home Page.

URL

<http://www.pro-face.com/otasuke/>

## 6. Inquiry

Do you have any questions about difficulties with this product?

Please access our site anytime that you need help with a solution.

<http://www.pro-face.com/otasuke/>

---

## 7. UL/c-UL Approval

---

The following unit is UL/c-UL listed product: (UL File No. E210412)

EXM-DDI8DT	EXM-DMM24DRF
EXM-DDI16DT	EXM-AMI2HT
EXM-DRA8RT	EXM-AMI4LT
EXM-DRA16RT	EXM-AMO1HT
EXM-DDO8UT	EXM-ALM3LT
EXM-DDO8TT	EXM-AMM3HT
EXM-DDO16UK	EXM-AMM6HT
EXM-DDO16TK	EXM-ARI8LT
EXM-DMM8DRT	EXM-AVO2HT

This product conforms to the following standards:

- UL508

Industrial Control Equipment

- UL1604

Electrical Equipment for Use in Class I and II, Division 2, and Class III Hazardous (classified) Locations

- CSA-C22.2 No.142-M1987 (c-UL Approval) Standard for Process Control Equipment
- CSA-C22.2 No.213-M1987 (c-UL Approval)

Non-Incendive Electrical Equipment for Use in Class I, Division 2 Hazardous Locations

UL1604/CSA-C22.2, No.213 - Compliance and Handling Cautions

This equipment is suitable for use in Class I, Division 2, Groups A, B, C, D or non-hazardous locations only.

Warning - Explosion Hazard - Substitution of components may impair suitability for Class I, Division 2.

Warning - Explosion Hazard - Do not disconnect equipment unless power has been switched off or the area is known to be non-hazardous.

---

## 8. CE Marking

---

This unit is CE marked product that conforms to EMC directives, EN55011 Class A and EN61131-2.

---

## 9. Revision

---

The revision is printed on the attached nameplate.

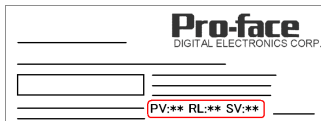

---

## 10. Contents

---

1. Essential Safety Precautions .....	2	15.13 Thermocouple Pt100 input/1-ch analog-output module.....	42
2. Package Contents .....	4	16. Dimensions .....	46
3. Supported Models and Software...	4	17. Installation.....	47
4. EX Modules Model Names.....	5	17.1 Installation requirements .....	47
5. About the Manual .....	6	17.2 Attachment/Removal .....	47
6. Inquiry.....	6	17.3 Mounting to / Removal from a DIN rail.....	49
7. UL/c-UL Approval .....	7	18. Wiring .....	49
8. CE Marking.....	7	18.1 Power Supply and FG Terminal .....	49
9. Revision .....	7	18.2 Terminal Connector .....	51
10. Contents .....	8	18.3 MIL Connector .....	52
11. System Design .....	9	18.4 Terminal Block (nonremoval) .....	52
12. Accessories .....	10	18.5 Wiring Precaution.....	52
12.1 Option Items .....	10		
13. Part Names and Functions .....	10		
14. General Specifications .....	12		
14.1 Electrical Specifications .....	12		
14.2 Environmental Specifications..	12		
14.3 Structural Specifications.....	13		
15. I/O Specifications .....	13		
15.1 8-point/16-point input module..	13		
15.2 8-point/16-point sink-output module .....	15		
15.3 8-point/16-point source-output module.....	16		
15.4 8-point/16-point relay-output module.....	18		
15.5 4-point inputs/4-point relay-output module,16-point inputs/8-point relay-output module .....	20		
15.6 2-ch analog-input module.....	24		
15.7 4-ch Analog input / Temperature input module.....	26		
15.8 8-ch Pt100/Pt1000 input module	29		
15.9 1-ch analog-output module.....	31		
15.10 2-ch analog-output module.....	33		
15.11 2-ch analog-input/1-ch analog-output module.....	35		
15.12 4-ch analog-input/2-ch analog-output module.....	39		



## 11. System Design

### ■ When using the LT3000 Series

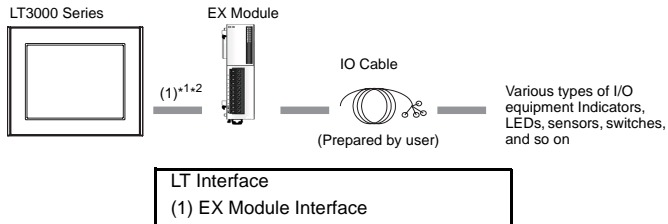

\*1 Up to two EX modules can be connected to the rear side of the LT-3200 series.  
Up to three EX modules can be connected to the rear side of the LT-3300 series.

\*2 As for EXM-DMM24DRF and EXM-ARI8LT, only one EX module can be connected to an LT.

### ■ When using the GP3000 Series CANopen board type

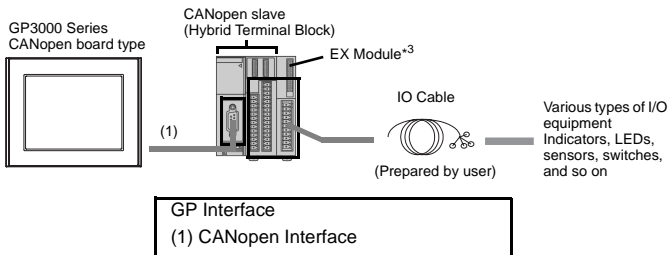

\*3 Up to seven EX modules can be connected next to the Hybrid Terminal Block (HTB).

## 12. Accessories

### 12.1 Option Items

	Product Name	Model No.	Description
Option Items	MIL Connector (20 pin) for EX Module	CA6-EXMCNHE20P-01	20 pin connector (MIL connector) only for EX module (a set of 5)
Maintenance Items	Terminal Connector (10 pin) for EX Module	CA6-EXMCNRS10P-01	10 pin connector (terminal block) only for EX module (a set of 5)
	Terminal Connector (11 pin) for EX Module	CA6-EXMCNRS11P-01	11 pin connector (terminal block) only for EX module (a set of 5)
	EX Module Securing Hook	CA7-FIXEXM-01	Hook for securing three EX modules to the LT-3300 series.

## 13. Part Names and Functions

EXM-DDI8DT  
EXM-DDO8UT  
EXM-DDO8TT  
EXM-DRA8RT  
EXM-DMM8DRT  
EXM-AMI2HT  
EXM-ALM3LT  
EXM-AMM3HT  
EXM-AMO1HT  
EXM-AMI4LT  
EXM-AVO2HT

EXM-DDI16DT  
EXM-DRA16RT  
EXM-AMM6HT

EXM-DDO16UK  
EXM-DDO16TK

EXM-DMM24DRF

EXM-ARI8LT

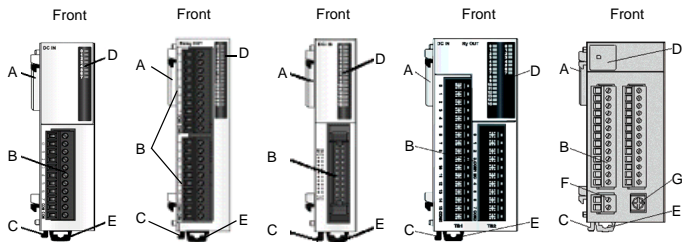

	Name		Description
A	Extension Connector		Connect the extension connector to the EX module interface at the rear side of the LT or connect the extension connector as the second connector for the LT to the EX module (the first unit). The extension plug-type connector is on the left side and the extension socket-type connector is mounted on the right side.
B	Terminal Block (Terminal Connector/Removable)	EXM-DDI8DT EXM-DDO8UT EXM-DDO8TT EXM-DRA8RT EXM-DMM8DRT EXM-AMI2HT EXM-ALM3LT EXM-AMM3HT EXM-AMO1HT EXM-DDI16DT EXM-DRA16RT EXM-AMI4LT EXM-ARI8LT EXM-AVO2HT EXM-AMM6HT	Terminals for external I/O interfaces
	Terminal Block (Nonremovable)	EXM-DMM24DRF	
	MIL Connector	EXM-DDO16UK EXM-DDO16TK	
C	Latch Button		Bracket that secures the EX module to the LT or secures two EX modules.
D	Status LED		Indicator that switches on and off as the input and the output signals turn on and off. (I/O module only)
	Power Indicator LED (PWR)		(Analog type only)
E	Clamp		For the extension (DIN rail mounting)
F	Power supply screw terminal block		DC24 V
G	Screw for functional ground		-

## 14. General Specifications

### 14.1 Electrical Specifications

Power Supply	Rated Voltage	5 VDC (Supplied from LT or HTB)	
	Power Consumption	EXM-DDI8DT	0.17 W max.
		EXM-DDI16DT	0.27 W max.
		EXM-DRA8RT	1.16 W max.
		EXM-DRA16RT	2.10 W max.
		EXM-DDO8UT	0.55 W max.
		EXM-DDO8TT	0.55 W max.
		EXM-DDO16UK	1.03 W max.
		EXM-DDO16TK	1.03 W max.
		EXM-DMM8DRT	0.65 W max.
		EXM-DMM24DRF	1.52 W max.
		EXM-AMI2HT	0.34 W max.
		EXM-AMI4LT	0.34 W max.
		EXM-ARI8LT	0.60 W max.
		EXM-AMO1HT	0.34 W max.
		EXM-AVO2HT	0.40 W max.
		EXM-ALM3LT	0.34 W max.
EXM-AMM3HT	0.34 W max.		
EXM-AMM6HT	0.40 W max.		

### 14.2 Environmental Specifications

Physical	Surrounding Operating Temperature	0 to 55°C
	Storage Temperature	-25 to +70°C
	Ambient Humidity	30 to 95%RH (Wet bulb temperature: 39°C max. - no condensation.)
	Storage Humidity	30 to 95%RH (Wet bulb temperature: 39°C max. - no condensation.)
	Pollution Degree	For use in Pollution Degree 2 environment

## 14.3 Structural Specifications

Installation Configuration	Connect the EX module directly to the rear side of the LT or to the right side of the EX module attached to the rear side of the LT.	
Cooling Method	Natural air circulation	
Weight Approx.	EXM-DDI8DT: 85 g EXM-DDI16DT: 100 g EXM-DDO8UT: 85 g EXM-DDO8TT: 85 g EXM-DDO16UK: 70 g EXM-DDO16TK: 70 g EXM-DRA8RT: 110 g EXM-DRA16RT: 145 g EXM-DMM8DRT: 95 g EXM-DMM24DRF: 140g	EXM-AMI2HT: 85 g <sup>*1</sup> , 100 g <sup>*2</sup> EXM-AMI4LT: 85g EXM-ALM3LT: 85 g <sup>*1</sup> , 100 g <sup>*2</sup> EXM-AMM3HT: 85 g <sup>*1</sup> , 100 g <sup>*2</sup> EXM-AMM6HT: 85g EXM-AMO1HT: 85 g <sup>*1</sup> , 100 g <sup>*2</sup> EXM-AVO2HT: 85g EXM-ARI8LT: 85g
Protective Structure	IP20	

\*1 Compatible with models that have revision "PV: 03 RL: 07 SV: 1.2". Please refer to "Revision" on page 5.

\*2 Compatible with models that have revision "PV: 04 RL: 08 SV: 2.0". Please refer to "Revision" on page 5.

## 15. I/O Specifications

### 15.1 8-point/16-point input module

	EXM-DDI8DT	EXM-DDI16DT
Rated Input Voltage	24 VDC	
Rated Input Voltage Range	DC20.4 to 28.8 V	
Rated Input Current	7.3 mA/input (when 24 VDC is applied)	
No. of Input Points	8 points (sink/source type - dual use)	16 points (sink/source type - dual use)
No. of Common	1	
Input ON Voltage	15 VDC or higher <sup>*1</sup>	
Input OFF Voltage	5 VDC or less <sup>*1</sup>	
Input Impedance	3.3 kΩ	
Isolation Method	Between input terminals and internal circuit: photocoupler isolated Between input terminals: not isolated	
Input Delay	OFF-ON	4 ms
	ON-OFF	4 ms
Usage Limits	No limits	Limits <sup>*2</sup>
External Connection	10-pin terminal connector	

\*1 Operating Range

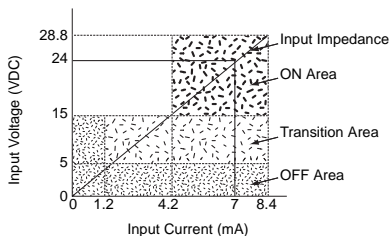

Input voltage / current characteristics 24 VDC (Input sink/source type)

\*2 Usage Limits (for EXM-DDI16DT)

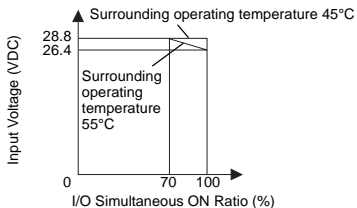

■ Input Circuit Drawings

◆ Internal Circuit

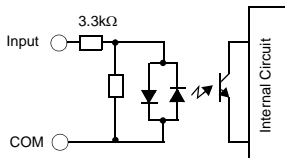

## ◆ Wiring

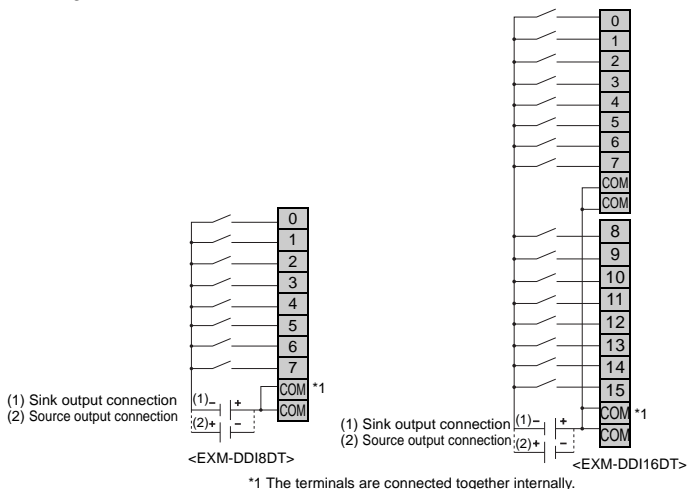

### 15.2 8-point/16-point sink-output module

		EXM-DDO8UT	EXM-DDO16UK
Rated Output Voltage		24 VDC	
Rated Output Voltage Range		DC20.4 to 28.8 V	
Output Method		Transistor sink output	
No. of Output Points		8 points	16 points
No. of Common		1	
Common Design		8 points/1 common	16 points/1 common
Maximum Load Voltage	Per Channel	0.3 A	0.1 A
	Per Common	3 A	1 A
Output Protection Type		Output is unprotected	
Output Voltage Drop		1 VDC or less (voltage between COM and output terminals when output is on)	
Clamp Voltage		39 VDC $\pm$ 1 V	
Voltage Leakage (When OFF)		0.1 mA or less	
Output Delay Time	OFF-ON	300 $\mu$ s or less	
	ON-OFF	300 $\mu$ s or less	

	EXM-DDO8UT	EXM-DDO16UK
Isolation Method	Between output terminals and internal circuit: photocoupler isolated Between output terminals: not isolated	
External Connection	10-pin terminal connector	MIL connector

### ■ Input Circuit Drawings

#### ◆ Internal Circuit

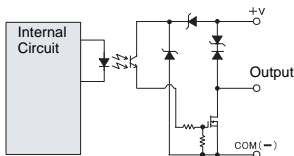

#### ◆ Wiring

□ indicates a fuse. L indicates load.

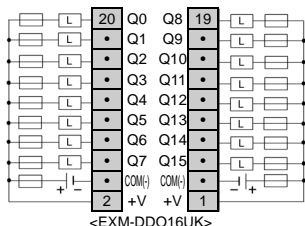
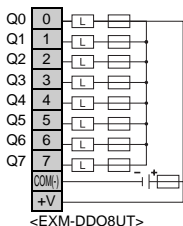

#### NOTE

- Since the output terminals are not electrically protected, an output line might be short-circuited or a connection fault might damage this product. Please install an applicable fuse to prevent an overload in the circuit, if necessary.

### 15.3 8-point/16-point source-output module

	EXM-DDO8TT	EXM-DDO16TK
Rated Output Voltage	24 VDC	
Rated Output Voltage Range	DC20.4 to 28.8 V	
Output Method	Transistor source output	
No. of Output Points	8 points	16 points
No. of Common	1	
Common Design	8 points/1 common	16 points/1 common



		EXM-DDO8TT	EXM-DDO16TK
Maximum Load Voltage	Per Channel	0.3 A	0.1 A
	Per Common	3 A	1 A
Output Protection Type		Output is unprotected	
Output Voltage Drop		1 VDC or less (voltage between COM and output terminals when output is on)	
Clamp Voltage		39 VDC $\pm$ 1 V	
Voltage Leakage (when OFF)		0.1 mA or less	
Output Delay Time	OFF-ON	300 $\mu$ s or less	
	ON-OFF	300 $\mu$ s or less	
Isolation Method		Between output terminals and internal circuit: photocoupler isolated Between output terminals: not isolated	
External Connection		10-pin terminal connector	MIL connector

## ■ Input Circuit Drawings

### ◆ Internal Circuit

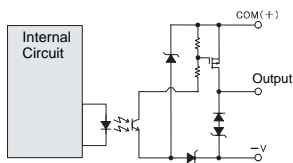

### ◆ Wiring

□ indicates a fuse. L indicates load.

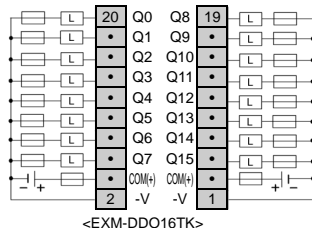
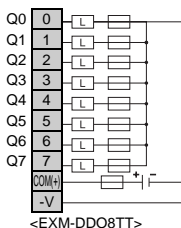

### NOTE

- Since the output terminals are not electrically protected, an output line might be short-circuited or a connection fault might damage this product. Please install an applicable fuse to prevent an overload in the circuit, if necessary.

**WARNING****RELAY OUTPUTS WELDED CLOSED**

- Always protect relay outputs from inductive alternating current load damage using an appropriate external protective circuit or device.
- Do not connect relay outputs to capacitive loads.

Failure to follow these instructions can result in death, serious injury, or equipment damage.

		EXM-DRA8RT	EXM-DRA16RT
No. of Output Points		8 points (4 points/1 common)	16 points (8 points/1 common)*1
No. of Common		2	
Output Method		1a-contact	
Maximum Load Voltage	Per Channel	2 A or less	
	Per Common	7 A or less	8 A or less
Maximum Load Voltage		0.1 mA/0.1 VDC (reference value)	
Contact Rating		240 VAC, 2 A (resistance load, $\cos \theta=0.4$ induced load)	
		30 VDC, 2 A (resistance load, L/R-7 ms induced load)	
Initial Shorting Resistance		30 m $\Omega$ max.	
Electrical Life		100,000 operations or more (rated resistive load 1,800 operations/h)	
Mechanical Life		20 million operations or more (no load 18,000 operations/h)	
Voltage Endurance		Between output to terminals: 1500 VAC, 1 minute Between output terminal and internal circuit: 1500 VAC, 1 minute Between output groups: 1500 VAC, 1 minute	
Output Delay Time			
External Connection		11-pin terminal connector	10-pin terminal connector

\*1 When connecting to Hybrid Terminal Block (HTB), up to 6 EXM-DRA16RT (up to 96 points of the total output points of EXM-DRA16RT) can be connected. When connecting EXM-DRA16RT up to 6, the following output modules cannot be connected to as the 7th module; EXM-DRA8RT, EXM-DRA16RT, EXM-DDO8UT, EXM-DDO8TT, EXM-DDO16UK, EXM-DDO16TK, EXM-DMM8DRT.

## ■ Input Circuit Drawings

### ◆ Internal Circuit

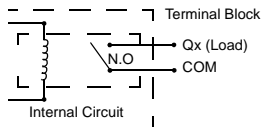

### ◆ Wiring

□ indicates a fuse. L indicates load.

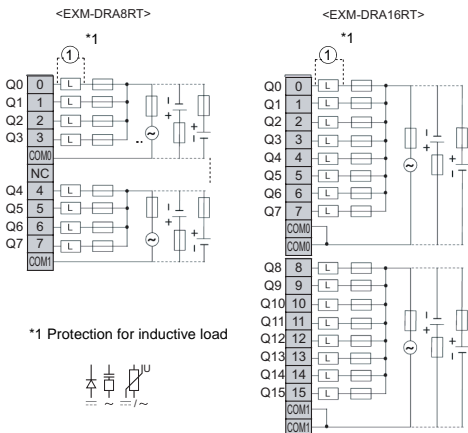

### NOTE

- The relay specifications can change the COM power supply.
- Since the output terminals are not electrically protected, an output line might be shortcircuited or a connection fault might damage this product. Please install an applicable fuse to prevent an overload in the circuit, if necessary.
- The COM0 and COM1 terminals are not connected together internally.
- Please be sure to refer 1.Essential Safety Precautions“About the Relay Output Inductive Load”, page 3

## 15.5 4-point inputs/4-point relay-output module, 16-point inputs/8-point relay-output module



### WARNING

#### RELAY OUTPUTS WELDED CLOSED

- Always protect relay outputs from inductive alternating current load damage using an appropriate external protective circuit or device.
- Do not connect relay outputs to capacitive loads.

Failure to follow these instructions can result in death, serious injury, or equipment damage.

		EXM-DMM8DRT	EXM-DMM24DRF
Rated Input Voltage		24 VDC	
Rated Input Voltage Range		DC20.4 to 28.8 V	
Rated Input Current		7.3 mA/input (when 24 VDC is applied)	7 mA/input (when 24 VDC is applied)
No. of Input Points		4 points (sink/source type - dual use)	16 points (sink/source type - dual use)
No. of Input Common		1	
Input ON Voltage		15 VDC or higher <sup>*1</sup>	
Input OFF Voltage		5 VDC or less <sup>*1</sup>	
Input Impedance		3.3 kΩ	3.4 kΩ
Isolation Method		Between input terminals and internal circuit: photocoupler isolated Between input terminals: not isolated	
Input Delay	OFF-ON	4 ms	
	ON-OFF	4 ms	
Usage Limits		No limits	Limits <sup>*2</sup>
External Load for I/O Interconnection		Not needed	
Signal Determination Method		LED lights when each point turns ON (logical side)	
No. of Output Points		4 points (4 points/1 common)	8 points
No. of Output Common		1 NO	2 NO
Output Method		1a-contact	
Maximum Load Current <sup>*3</sup>	Per Channel	2 A or less	
	Per Common	7 A or less	
Min. Open/Close Load		0.1 mA/0.1 VDC (reference value)	

	EXM-DMM8DRT	EXM-DMM24DRF
Contact Rating	240 VAC, 2 A (resistance load, $\cos \phi=0.4$ induced load) 30 VDC, 2 A (resistance load, L/R-7 ms induced load)	
Output Delay Time	<p>Command ON OFF</p> <p>Output Relay Status ON OFF</p> <p>OFF delay: 10 ms max.</p> <p>Contact bounce: 6 ms max.</p> <p>ON delay: 6 ms max.</p>	
Initial Shorting Resistance	30 m $\Omega$ max.	45 m $\Omega$ max.
Electrical Life	100,000 operations or more (rated resistive load 1,800 operations/h)	
Mechanical Life	20 million operations or more (no load 18,000 operations/h)	
Voltage Endurance	Between output to terminals: 1500 VAC, 1 minute Between output terminal and internal circuit: 1500 VAC, 1 minute Between output groups: 1500 VAC, 1 minute	
External Connection	11-pin terminal connector	Terminal Block (nonremoval)

\*1 Operating Range

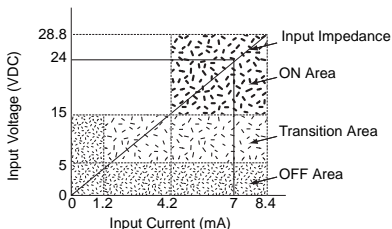

\*2 Usage Limits (for EXM-DMM24DRF)

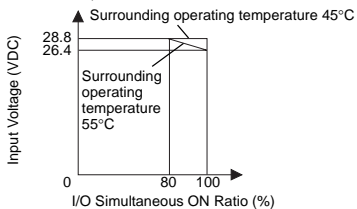

\*3 Value when the resistance load or induction load is applied.

■ Input/Output Circuit Drawings

◆ Internal Circuit

<Input>

- Sink/Source Input

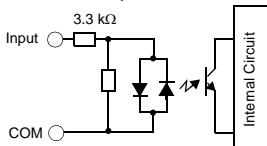

<Output>

- Relay Output Contact

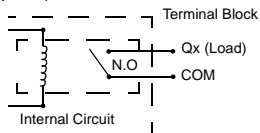

## ◆ Wiring

□ indicates a fuse. L indicates load.

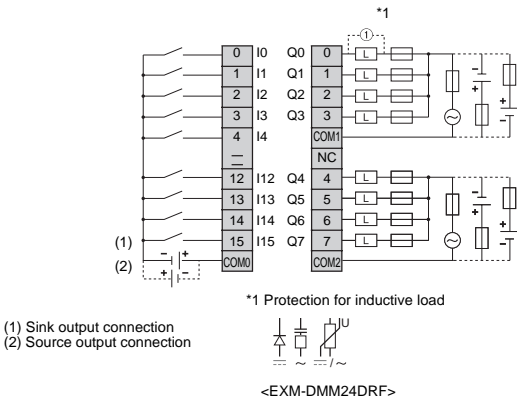
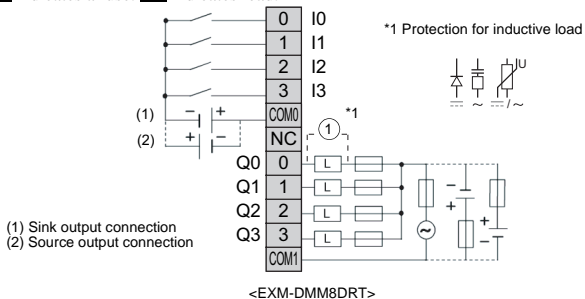

### NOTE

- The COM0, COM1 and COM2 terminals are not connected together internally.
- Since the output terminals are not electrically protected, an output line might be short-circuited or a connection fault might damage this product. Please install an applicable fuse to prevent an overload in the circuit, if necessary.
- Please be sure to refer 1.Essential Safety Precautions“About the Relay Output Inductive Load” on page 3

## 15.6 2-ch analog-input module

The detail of the external power supply is: the rated supply voltage is 24 VDC, the rated input voltage ranges from DC20.4 to 28.8 V The consumption current is 35 mA\*1 or 40 mA\*2 (24VDC) when the input is not-open, output 100%. You can select either voltage or current for each input channel.

		EXM-AMI2HT	
Characteristics of Analog Voltage Inputs		Voltage Input	Current Input
Input Range		From DC0 to 10 V	From DC4 to 20 mA
Input Impedance		1 M $\Omega$ min.	10 $\Omega$
Input Points		2 points	
A-D Conversion	Sample Repetition Time	20 ms max.	
	Total Input System Transfer Time*3	105 ms + 1 scan time*1 60 ms + 1 scan time*2	
	Input Type	Single-ended input	Differential input
	Operating Mode	Self-scan	
	Conversion Mode	$\Sigma\Delta$ type ADC	
Input Error	Maximum Error at 25°C (77°F)	$\pm 0.2\%$ of full scale	
	Temperature Coefficient	$\pm 0.006\%$ of full scale/°C	
	Repeatable after Stabilization Time	$\pm 0.5\%$ of full scale	
	Nonlinear	$\pm 0.2\%$ of full scale	
	Maximum error	$\pm 1\%$ of full scale	
Data	Digital Resolution	4096 increments (12 bits)	
	Input Value of LSB	2.5 mV	4 $\mu$ A
	Data Type in Application Program	0 to 4095 (12 bit data) -32768 to 32767 (optional range designation)*4	
	Monotonicity	Yes	
	Input Data Out of Range	Detectable*5*6	
Noise Resistance	Maximum Temporary Deviation during Electrical Noise Tests	$\pm 3\%$ maximum*1 or $\pm 1\%$ maximum*2 when a 1 kV clamp voltage is applied to the I/O wiring and 1 kV is applied to the power directly.	
	Common Mode Characteristics	Common mode reject ratio (CMRR): -50 dB	
	Common Mode Voltage	16 VDC	
	Input Filter	No	
	Cable	Twisted-pair shielded cable is recommended for improved noise immunity	
	Crosstalk	2 LSB max.	
Voltage Endurance		500 V between input and power circuit	
Isolation Method		Photocoupler Isolation between input and internal circuit	



EXM-AMI2HT		
Characteristics of Analog Voltage Inputs	Voltage Input	Current Input
Maximum Permanent Allowed Overload (No Damage)	13 VDC	40 mA DC
Selection of Analog Input Signal Type	Using software programming	
Calibration or Verification to Maintain Rated Accuracy	Approximately 10 years	
Disconnection detection	No	
External Connection	11-pin terminal connector	

- \*1 Compatible with models that have revision "PV: 03 RL: 07 SV: 1.2". Please refer to "Revision" on page 5.
- \*2 Compatible with models that have revision "PV: 04 RL: 08 SV: 2.0". Please refer to "Revision" on page 5.
- \*3 Total input system transfer time = sample repetition × 2 + internal operation time + 1 scan time.  
As for revision "PV: 03 RL: 07 SV: 1.2", the value is maximum time. Typ. 33ms + 1 scan time.  
As for revision "PV: 04 RL: 08 SV: 2.0", the value is maximum time. Typ. 26.5ms + 1 scan time.
- \*4 The 12-bit data (0 to 4095) and 10-bit data (0 to 1023) processed in the Analog I/O module can be linear converted to a value between -32768 and 32767.  
The Optional range designation and analog I/O data minimum and maximum values can be selected using data registers allocated to analog I/O modules.
- \*5 As for voltage input data out of range (less than DC 0V, more than DC 10V), or current input data out of range (less than DC 4mA, more than DC 20mA), the error code RGEF130 (Input data error) is output for the analog module. Once the error occurs, input data from the point of the error is no longer updated. For more information about error codes, read the "Maintenance/Troubleshooting Guide".
- \*6 The input value may be regarded as "Input Data Out of Range" due to the maximum error even when it is in the specified input range. Before inputting the value, therefore, consider the maximum error.

## ◆ Wiring

□ indicates a fuse.

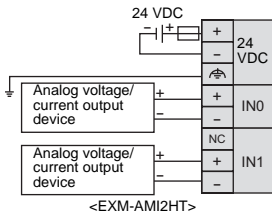

external power-supply or it may not operate properly.

- Be sure the analog OUT lines are placed in a separate duct from high-frequency, live lines such as high-voltage, high-power lines, inverters, etc.

### IMPORTANT

- The power for the analog module should be supplied separately from the LT.  
Turn the analog module on before turning the LT on. Wait at least 30 seconds after power-off to restart the

**NOTE**

- Connect a fuse appropriate for the applied voltage and current draw, at the position shown in the diagram.
- When the voltage input is open, the input into the unused channels is approx. 2.5 VDC for revision "PV: 03 RL: 07 SV: 1.2" and 0 VDC for revision "PV: 04 RL: 08 SV: 2.0". When the voltage input is short circuited, 0 VDC is input to them. Please shortcircuit to prevent from the invalid values input. When the current input is open, error code (RGEF130 input data error) occurs to the unused channels, then the invalid values are input. The voltage input settings is recommended to the unused channels.
- The (-) poles of inputs IN0 and IN1 are connected internally.

## 15.7 4-ch Analog input / Temperature input module

The detail of the external power supply is: the rated supply voltage is 24 VDC, the rated input voltage ranges from DC19.2 to 30 V including ripple. The consumption current is 60 mA (24 VDC) when the input is not-open, output 100%. You can input voltage, current, or temperature probes on up to 4 channels. You cannot use different types of input at the same time.

		EXM-AMI4LT		
Characteristics of Analog Voltage Inputs		Voltage Input	Current Input	Temperature Probes
Input Range		DC0 to 10 V	DC0 to 20 mA	(RTD) Pt100/Pt1000/ Ni100/Ni1000, 3-wire type Pt sensor: -200 to +600°C (-328 to +1112°F) Ni sensor: -50 to +150°C (-58 to +302°F)
Input Impedance		10 k $\Omega$ min.	250 $\Omega$ max.	10 k $\Omega$ min.
Input Points		4 points		
A-D Conversion	Sample Repetition Time	160 ms		
	Total Input System Transfer Time*1	4x160 ms + 1 scan time		8x160 ms + 1 scan time
	Input Type	Non differential input		
	Operating Mode	Self-scan		
Conversion Mode		$\Sigma\Delta$ type ADC		
Input Error	Maximum Error at 25°C (77°F)	$\pm 0.2\%$ of full scale $\pm 0.4\%$ temperature probe input		
	Temperature Coefficient	$\pm 0.005\%$ of full scale/°C		

		EXM-AMI4LT		
Characteristics of Analog Voltage Inputs		Voltage Input	Current Input	Temperature Probes
Data	Digital Resolution	4096 increments (12 bits)		
	Input Value of LSB	2.5 mV	4.8 $\mu$ A	Pt: 0.20 °C (32.36 °F) Ni: 0.05 °C (32.09 °F)
	Data Type in Application Program	0 to 4095 (12 bit) Custom range up to -32768 to +32767*2		Celsius / Fahrenheit
	Input Data Out of Range	Detectable*3*4		
Noise Resistance	Cable	Twisted-pair shielded cable is recommended for improved noise immunity		
	Crosstalk	1 LSB max.		
Voltage Endurance		2500 VAC between inputs, external power supply and internal logic circuits		
Isolation Method		Photocoupler Isolation between input and internal circuit (1500 VDC isolation)		
Maximum Permanent Allowed Overload (No Damage)		13 VDC	40 mA	-
Selection of Analog Input Signal Type		Using software programming <b>NOTE</b> All inputs have the same voltage/current configuration or temperature. For temperature, it is possible to configure each channel independently of the type of probe.		
Calibration or Verification to Maintain Rated Accuracy		Approximately 10 years		
Default input value in case of temperature sensor disconnection		Upper limit*5		
External Connection		11-pin terminal connector		

\*1 Total input system transfer time = sample repetition  $\times$  2 + 1 scan time.

\*2 The 12-bit data (0 to 4095) processed in the Analog I/O module can be linear converted to a value between -32768 and 32767. The optional range designation and analog I/O data minimum and maximum values can be selected using data registers allocated to analog I/O modules.

\*3 If the input data is not in the range, the error code RGEF130 (Input data error) is output for the analog module. Once the error occurs, input data from the point of the error is no longer updated. For more information about error codes, read the "Maintenance/Troubleshooting Guide".

\*4 The input value may be regarded as "Input Data Out of Range" due to the maximum error even when it is in the specified input range. Before inputting the value, therefore, consider the maximum error.

\*5 Only when connected to Hybrid Terminal Block (HTB)

## ◆ Wiring

□ indicates a fuse.

This wiring diagram is for inputs configured for measuring temperature.

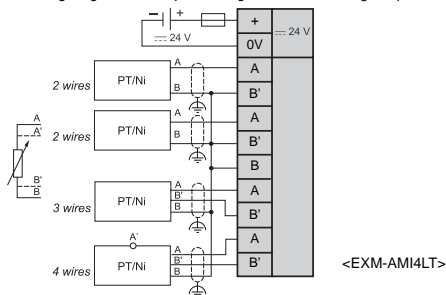

### NOTE

- For 4-wire cabling, “output A’ ” is not connected.

This wiring diagram is for inputs configured for measuring voltage/current.

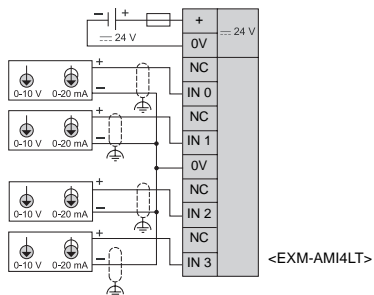

### IMPORTANT

- The power for the analog module should be supplied separately from the LT. Turn the analog module on before turning the LT on. Wait at least 30 seconds after power-off to restart the external power-supply or it may not operate properly.

### NOTE

- Connect an appropriate fuse for the applied voltage and current draw, at the position shown in the diagram.
- Do not connect any wiring to unused channels.

## 15.8 8-ch Pt100/Pt1000 input module

The detail of the external power supply is: the rated supply voltage is 24 VDC, the rated input voltage ranges from DC20.4 to 28.8 V. The consumption current is 140 mA (24 VDC) when the input is not-open, output 100%.

		EXM-ARI8LT
Sensor type		Temperature Probes
Input Range		Pt1000: -50 to +200°C (-58 to +392°F) Pt100: -200 to +600°C (-328 to +1112°F)
Input Impedance		10 kΩ min.
Input Points		8 points
A-D Conversion	Sample Repetition Time	320 ms per channel
	Total Input System Transfer Time* <sup>1</sup>	4x320 ms + 1 scan time
	Input Type	Differential input
	Operating Mode	Self-scan
	Conversion Mode	ΣΔ type ADC
Input Error	Maximum Error at 25°C (77°F)	Pt1000: ±0.5°C (0.9°F) Pt100: ±1.5°C (2.7°F) Range -50°C (-58°F) to +200°C (+392°F): ±1°C(±33.8°F) Range -200°C (392°F) to 600°C (1112°F): +0.1% / -0.5% full scale
	Temperature Coefficient	±0.5°C (0.9°F)
Characteristics of Voltage, Current & Temperature Inputs	Repeatable after Stabilization Time	±0.1°C (±32.18°F)
	Total maximum deviation	Pt1000: ±1°C (±33.8°F) Pt100: +1°C (33.8°F)/-4°C (24.8°F)
Data	Digital Resolution	4096 increments (12 bits)
	Input Value of LSB	Pt1000: 0.06°C (0.108°F) Pt100: 0.2°C (0.36°F)
	Data Type in Application Program	0 to 4095 (12 bit) Custom range up to -32768 to +32767* <sup>2</sup>
	Input Data Out of Range	Detectable* <sup>3*4</sup>
	Broken wire detection	Detectable* <sup>3</sup>
Noise Resistance	Cable	Twisted-pair shielded cable is recommended for improved noise immunity
	Crosstalk	1 LSB max.
Voltage Endurance		-2500 VAC between inputs, external power supply and internal logic circuits - 1500 Vrms between inputs and internal bus - 500 Vrms between inputs and ground -1500 Vrms between internal bus and ground
Isolation Method		Photocoupler Isolation between input and internal circuit (1500 VDC isolation)

	EXM-ARI8LT
Selection of Analog Input Signal Type	Using software programming <b>NOTE</b> It is possible to use Pt100 and Pt 1000's probe.
Calibration or Verification to Maintain Rated Accuracy	Approximately 10 years
Default input value in case of temperature sensor disconnection	Upper limit
External Connection	2 x 13-pin terminal connector 1 x 2-pin power supply screw terminal block

\*1 Total input system transfer time = sample repetition × 2 + 1 scan time.

\*2 The 12-bit data (0 to 4095) processed in the Analog I/O module can be linear converted to a value between -32768 and 32767. The optional range designation and analog I/O data minimum and maximum values can be selected using data registers allocated to analog I/O modules.

\*3 If the input data is not in the range, the error code RGEF130 (Input data error) is output for the analog module. Once the error occurs, input data from the point of the error is no longer updated. For more information about error codes, read the "Maintenance/Troubleshooting Guide".

\*4 The input value may be regarded as "Input Data Out of Range" due to the total maximum deviation even when it is in the specified input range. Before inputting the value, therefore, consider the total maximum deviation.

## ◆ Wiring

□ indicates a fuse.

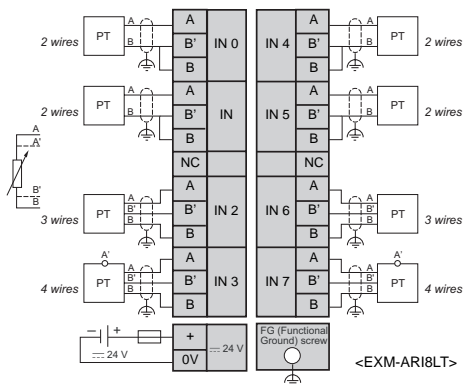

### IMPORTANT

- The power for the analog module should be supplied separately from the LT. Turn the analog module on before turning the LT on. Wait at least 30 seconds after power-off to restart the external power-supply or it may not operate properly.

### NOTE

- Connect an appropriate fuse for the applied voltage and current draw, at the position shown in the diagram.
- Do not connect any wiring to unused channels.

## 15.9 1-ch analog-output module

The detail of the external power supply is: the rated supply voltage is 24 VDC, the rated input voltage ranges from DC20.4 to 28.8 V. The consumption current is 40 mA (24 VDC) when the input is not-open, output 100%.

		EXM-AMO1HT	
Analog Output Specifications		Voltage Output	Current Output
Rated Output Voltage Range		From DC0 to 10 V	From DC4 to 20 mA
Load	Load Impedance	2 k $\Omega$ min.*1, 1 k $\Omega$ min.*2	300 $\Omega$ max.
	Application Load Type	Resistive load	
D-A Conversion	Conversion Time	50 ms*1 10 ms*2	
	Total Output System Transfer Time	50 ms + 1 scan time*1 10 ms + 1 scan time*2	

		EXM-AMO1HT	
Analog Output Specifications		Voltage Output	Current Output
Output Error	Maximum Error at 25°C (77°F)	±0.2% of full scale	
	Temperature Coefficient	±0.015% of full scale/°C	
	Repeatable after Stabilization Time	±0.5% of full scale	
	Output Voltage Drop	±1% of full scale	-
	Nonlinear	±0.2% of full scale	
	Output Ripple	1 LSB max.	
	Overshoot	0%	
	Total Error	±1% of full scale	
Data	Digital Resolution	4,096 increments (12 bits)	
	Output Value of LSB	2.5 mV	4 µA
	Data Type in Application Program	0 to 4095 (12 bit data) -32768 to 32767 (optional range designation)*3	
	Monotonicity	Yes	
	Current Loop Open	-	Not detectable
Noise Resistance	Maximum Temporary Deviation during Electrical Noise Tests	±3% maximum*1 or ±1% maximum*2 when a 1 kV clamp voltage is applied to the I/O wiring and 1 kV is applied to the power directly.	
	Cable	Twisted-pair shielded cable is recommended for improved noise immunity	
	Crosstalk	No crosstalk because of 1 channel output	
Voltage Endurance		500V between output and power circuit	
Isolation Method		Photocoupler Isolation between output and internal circuit	
Selection of Analog Output Signal Type		Using software programming	
Calibration or Verification to Maintain Rated Accuracy		Approximately 10 years	
External Connection		11-pin terminal connector	

\*1 Compatible with models that have revision "PV: 03 RL: 07 SV: 1.2". Please refer to "Revision" on page 5.

\*2 Compatible with models that have revision "PV: 04 RL: 08 SV: 2.0". Please refer to "Revision" on page 5.

\*3 The 12-bit data (0 to 4095) processed in the Analog I/O module can be linear converted to a value between -32768 and 32767. The optional range designation and analog I/O data minimum and maximum values can be selected using data registers allocated to analog I/O modules.



## ◆ Wiring

□ indicates a fuse.

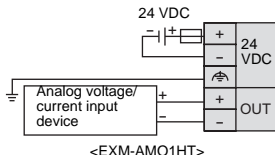

### IMPORTANT

- The power for the analog module should be supplied separately from the LT. Turn the analog module on before turning the LT on. Wait at least 30 seconds after power-off to restart the external power-supply or it may not operate properly.
- Be sure the analog OUT lines are placed in a separate duct from high-frequency, live lines such as high-voltage, high-power lines, inverters, etc.

### NOTE

- Connect a fuse appropriate for the applied voltage and current draw, at the position shown in the diagram.
- Do not connect any wiring to unused channels.

## 15.10 2-ch analog-output module

The detail of the external power supply is: the rated supply voltage is 24 VDC, the rated input voltage ranges from DC19.2 to 30 V including ripple. The consumption current is 60 mA (24 VDC) when the input is not-open, output 100%.

		EXM-AVO2HT
Analog Output Specifications		Voltage Output
Rated Output Voltage Range		From DC -10 to +10 V
Load	Load Impedance	3 k $\Omega$ min.
	Application Load Type	Resistive load
D-A Conversion	Conversion Time	2 ms
	Total Output System Transfer Time* <sup>1</sup>	2 ms + 1 scan time

		EXM-AVO2HT
Analog Output Specifications		Voltage Output
Output Error	Maximum Error at 25°C (77°F)	±0.5% of full scale
	Temperature Coefficient	±0.01% of full scale/°C
	Repeatable after Stabilization Time	±0.1% of full scale
	Output voltage drop	±0.5% of full scale
	Nonlinear	±0.2% of full scale
	Output Ripple	1 LSB max.
	Overshoot	0%
	Total Error	±1% of full scale
Data	Digital Resolution	11 bits + sign
	Output Value of LSB	±9.8 mV
	Data Type in Application Program	-2,048 to +2,047* <sup>1</sup> Custom range up to -32768 to +32767
	Current Loop Open	Not Detectable
Noise Resistance	Maximum Temporary Deviation during Electrical Noise Tests	±1% of full scale
	Cable	Twisted-pair shielded cable is recommended for improved noise immunity
	Crosstalk	No crosstalk because of 1channel output
Voltage Endurance		2500 VAC by photocoupler between outputs, external power supply and internal logic circuits
Selection of Analog Output Signal Type		Using software programming
Calibration or Verification to Maintain Rated Accuracy		Approximately 10 years
External Connection		11-pin terminal connector

\*1 The 12-bit data (0 to 4095) processed in the Analog I/O module can be linear converted to a value between -32768 and 32767. The optional range designation and analog I/O data minimum and maximum values can be selected using data registers allocated to analog I/O modules.

## ◆ Wiring

□ indicates a fuse.

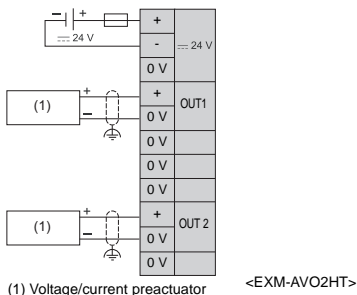

### IMPORTANT

- The power for the analog module should be supplied separately from the LT. Turn the analog module on before turning the LT on. Wait at least 30 seconds after power-off to restart the external power-supply or it may not operate properly.

### NOTE

- Use the braid supplied with the module to connect the functional ground.
- Connect an appropriate fuse for the applied voltage and current draw, at the position shown in the diagram.
- To avoid disturbances on the analog outputs, the power supply of the EXM-AVO2HT module must be turned on or off at the same time than the base controller power supply.

## 15.11 2-ch analog-input/1-ch analog-output module

The detail of the external power supply is: the rated supply voltage is 24 VDC, the rated input voltage ranges from DC20.4 to 28.8 V. The consumption current is 45 mA\*1 or 50 mA\*2 (24VDC) when the input is not-open, output 100%. You can select either voltage or current for each input or output channel.

		EXM-AMM3HT	
Characteristics of Analog Voltage Inputs		Voltage Input	Current Input
Input Range		From DC0 to 10V	From DC4 to 20 mA
Input Impedance		1 M $\Omega$ min.	10 $\Omega$
Input Points		2 points	
A-D Conversion	Sample Repetition Time	20 ms max.	
	Total Input System Transfer Time*3	105 ms + 1 scan time*1 60 ms + 1 scan time*2	
	Input Type	Single-ended input	Differential input
	Operating Mode	Self-scan	
	Conversion Mode	$\Sigma\Delta$ type ADC	

		EXM-AMM3HT	
Characteristics of Analog Voltage Inputs		Voltage Input	Current Input
Input Error	Maximum Error at 25°C (77°F)	±0.2% of full scale	
	Temperature Coefficient	±0.006% of full scale/°C	
	Repeatable After Stabilization Time	±0.5% of full scale	
	Nonlinear	±0.2% of full scale	
	Maximum Error	±1% of full scale	
Data	Digital Resolution	4096 increments (12 bits)	
	Input Value of LSB	2.5 mV	4 µA
	Data Type in Application Program	0 to 4095 (12 bit data) -32768 to 32767 (optional range designation)*4	
	Monotonicity	Yes	
	Input Data Out of Range	Detectable*5*6	
Noise Resistance	Maximum Temporary Deviation during Electrical Noise Tests	±3% maximum when a 1 kV clamp voltage is applied to the I/O wiring and 1 kV is applied to the power directly.	
	Common Mode Characteristics	Common mode reject ratio (CMRR): -50 dB	
	Common Mode Voltage	16 VDC	
	Input Filter	No	
	Cable	Twisted-pair shielded cable is recommended for improved noise immunity	
	Crosstalk	2 LSB max.	
Voltage Endurance	500 V between input and power circuit		
Isolation Method	Photocoupler between input and internal circuit		
Maximum Permanent Allowed Overload (No Damage)	13 VDC	40 mA DC	
Selection of Analog Input Signal Type	Using software programming		
Calibration or Verification to Maintain Rated Accuracy	Approximately 10 years		
Disconnection detection	No		
External Connection	11-pin terminal connector		

\*1 Compatible with models that have revision "PV: 03 RL: 07 SV: 1.2". Please refer to "Revision" on page 5.

\*2 Compatible with models that have revision "PV: 04 RL: 08 SV: 2.0". Please refer to "Revision" on page 5.

\*3 Total input system transfer time = sample repetition × 2 + internal operation time + 1 scan time.

As for revision "PV: 03 RL: 07 SV: 1.2", the value is maximum time. Typ. 33ms + 1 scan time.

As for revision "PV: 04 RL: 08 SV: 2.0", the value is maximum time. Typ. 26.5ms + 1 scan time.

\*4 The 12-bit data (0 to 4095) and 10-bit data (0 to 1023) processed in the Analog I/O module can be linear converted to a value between -32768 and 32767.

The Optional range designation and analog I/O data minimum and maximum values can be selected using data registers allocated to analog I/O modules.

\*5 As for voltage input data out of range (less than DC 0V, more than DC 10V), or current input data out of range (less than DC 4mA, more than DC 20mA), the error code RGEF130 (Input data error) is output for the analog module. Once the error occurs, input data from the point of the error is no longer updated. For more information about error codes, read the "Maintenance/Troubleshooting Guide".

\*6 The input value may be regarded as "Input Data Out of Range" due to the maximum error even when it

is in the specified input range. Before inputting the value, therefore, consider the maximum error.

		EXM-AMM3HT	
Analog Output Specifications		Voltage Output	Current Output
Rated Output Voltage Range		From DC0 to 10 V	From DC4 to 20 mA
Load	Load Impedance	2 k $\Omega$ min.*1, 1 k $\Omega$ min.*2	300 $\Omega$ max.
	Application Load Type	Resistive load	
D-A Conversion	Conversion Time	50 ms*1 10 ms*2	
	Total Output System Transfer Time	50 ms + 1 scan time*1 10 ms + 1 scan time*2	
Output Error	Maximum Error at 25°C (77°F)	$\pm 0.2\%$ of full scale	
	Temperature Coefficient	$\pm 0.015\%$ of full scale/°C	
	Repeatable after Stabilization Time	$\pm 0.5\%$ of full scale	
	Output Voltage Drop	$\pm 1\%$ of full scale	-
	Nonlinear	$\pm 0.2\%$ of full scale	
	Output Ripple	1 LSB max.	
	Overshoot	0%	
	Total Error	$\pm 1\%$ of full scale	
Data	Digital Resolution	4,096 increments (12 bits)	
	Output Value of LSB	2.5 mV	4 $\mu$ A
	Data Type in Application Program	0 to 4095 (12 bit data) -32768 to 32767 (optional range designation)*3	
	Monotonicity	Yes	
	Current Loop Open	-	Not detectable
Noise Resistance	Maximum Temporary Deviation during Electrical Noise Tests	$\pm 3\%$ maximum*1 or $\pm 1\%$ maximum*2 when a 1 kV clamp voltage is applied to the I/O wiring and 1 kV is applied to the power directly.	
	Cable	Twisted-pair shielded cable is recommended for improved noise immunity	
	Crosstalk	No crosstalk because of 1 channel output	
Voltage Endurance		500 V between output and power circuit	
Isolation Method		Photocoupler Isolation between output and internal circuit	
Selection of Analog Output Signal Type		Using software programming	
Calibration or Verification to Maintain Rated Accuracy		Approximately 10 years	
Disconnection detection		No	
External Connection		11-pin terminal Connector	

\*1 Compatible with models that have revision "PV: 03 RL: 07 SV: 1.2". Please refer to "Revision" on page 5.

\*2 Compatible with models that have revision "PV: 04 RL: 08 SV: 2.0". Please refer to "Revision" on page 5.

\*3 The 12-bit data (0 to 4095) processed in the Analog I/O module can be linear converted to a value between -32768 and 32767. The optional range designation and analog I/O data minimum and maximum values can be selected using data registers allocated to analog I/O modules.

## ◆ Wiring

□ indicates a fuse.

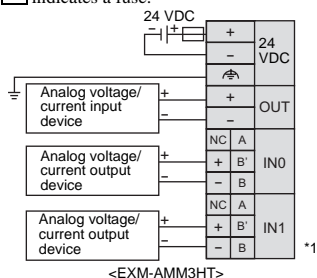

\*1 The (-) poles of inputs IN0 and IN1 are connected internally

## NOTE

- Connect a fuse appropriate for the applied voltage and current draw, at the position shown in the diagram.
- When the voltage input is open, the input into the unused channels is approx. 2.5 VDC for revision “PV: 03 RL: 07 SV: 1.2” and 0 VDC for revision “PV: 04 RL: 08 SV: 2.0”. When the voltage input is short circuited, 0 VDC is input to them. Please shortcircuit to prevent from the invalid values input. When the current input is open, error code (RGEF130 input data error) occurs to the unused channels, then the invalid values are input. The voltage input settings is recommended to the unused channels.

## IMPORTANT

- The power for the analog module should be supplied separately from the LT. Turn the analog module on before turning the LT on. Wait at least 30 seconds after power-off to restart the external power-supply or it may not operate properly.
- Be sure the analog IN/OUT lines are placed in a separate duct from high-frequency, live lines such as high-voltage, high-power lines, inverters, etc.

## 15.12 4-ch analog-input/2-ch analog-output module

The detail of the external power supply is: the rated supply voltage is 24 VDC, the rated input voltage ranges from DC20.4 to 28.8 V. The consumption current is 80 mA (24 VDC) when the input is not-open, output 100%. You can select voltage or current for each input or output channel.

		EXM-AMM6HT	
Characteristics of Analog Voltage Inputs		Voltage Input	Current Input
Input Range		DC0 to 10 V	DC4 to 20 mA
Input Impedance		1 M $\Omega$	250 $\Omega$ max.
Input Points		4 points	
A-D Conversion	Sample Repetition Time	64 ms	
	Total Input System Transfer Time* <sup>1</sup>	4x64 ms + 1 scan time	
	Input Type	Non differential input	
	Operating Mode	Self-scan	
	Conversion Mode	$\Sigma\Delta$ type ADC	
Input Error	Maximum Error at 25°C (77°F)	$\pm 0.5\%$ of full scale	
	Temperature Coefficient	$\pm 0.015\%$ of full scale/°C	
Characteristics of Voltage & Current Inputs	Repeatable after Stabilization Time	$\pm 0.5\%$ of full scale	
	Nonlinear	$\pm 0.4\%$ of full scale	
	Maximum Error	$\pm 1\%$ of full scale	
Data	Digital Resolution	4096 increments (12 bits)	
	Input Value of LSB	2.5 mV	4.8 $\mu$ A
	Data Type in Application Program	0 to 4095 (12 bit) Custom range up to -32768 to +32767* <sup>2</sup>	
	Input Data Out of Range	Detectable* <sup>3*4</sup>	
Noise Resistance	Maximum Temporary Deviation during Electrical Noise Tests	$\pm 2\%$ of full scale	
	Cable	Twisted-pair shielded cable is recommended for improved noise immunity	
	Crosstalk	1 LSB max.	
Voltage Endurance		800 VAC	
Isolation Method		Photocoupler Isolation between inputs, and internal circuits	
Maximum Permanent Allowed Overload (No Damage)		30 VDC	40 mA
Selection of Analog Input Signal Type		Using software programming	
Calibration or Verification to Maintain Rated Accuracy		Approximately 10 years	
External Connection		10-pin terminal connector	

- \*1 Total input system transfer time = sample repetition × active channel number + 1 scan time.
- \*2 The 12-bit data (0 to 4095) processed in the Analog I/O module can be linear converted to a value between -32768 and 32767. The optional range designation and analog I/O data minimum and maximum values can be selected using data registers allocated to analog I/O modules.
- \*3 If the input data is not in the range, the error code RGEF130 (Input data error) is output for the analog module. Once the error occurs, input data from the point of the error is no longer updated. For more information about error codes, read the "Maintenance/Troubleshooting Guide".
- \*4 The input value may be regarded as "Input Data Out of Range" due to the maximum error even when it is in the specified input range. Before inputting the value, therefore, consider the maximum error.

		EXM-AMM6HT	
Analog Output Specifications		Voltage Output	Current Output
Rated Output Voltage Range		DC0 to 10 V	From DC4 to 20 mA
Load	Load Impedance	2 kΩ min.	300 Ω max.
	Application Load Type	Resistive load	
D-A Conversion	Conversion Time	20 ms	
	Total Output System Transfer Time*1	20 ms + 1 scan time	
Output Error	Maximum Error at 25°C (77°F)	±0.9% of full scale	
	Temperature Coefficient	±0.015% of full scale/°C	
	Repeatable after Stabilization Time	±1% of full scale	
	Output voltage drop	±1% of full scale	
	Nonlinear	±0.5% of full scale	
	Output Ripple	±0.5% of full scale	
	Overshoot	±0.5% of full scale	
	Total Error	±1.5% of full scale	
Data	Digital Resolution	4096 increments (12 bits)	
	Output Value of LSB	2.5 mV	4.8 μA
	Data Type in Application Program	0 to 4095 (12 bit data) Custom range up to -32768 to +32767*1	
Noise Resistance	Maximum Temporary Deviation during Electrical Noise Tests	±1% of full scale	
	Cable	Twisted-pair shielded cable is recommended for improved noise immunity	
	Crosstalk	±0.1% of full scale max.	
Voltage Endurance		800 VAC	
Isolation Method		Photocoupler Isolation between outputs and internal circuit	
Selection of Analog Input Signal Type		Using software programming	
Calibration or Verification to Maintain Rated Accuracy		Approximately 10 years	
External Connection		10-pin terminal connector	

\*1 The 12-bit data (0 to 4095) processed in the Analog I/O module can be linear converted to a value between -32768 and 32767. The optional range designation and analog I/O data minimum and maximum values can be selected using data registers allocated to analog I/O modules.



## ◆ Wiring

□ indicates a fuse.

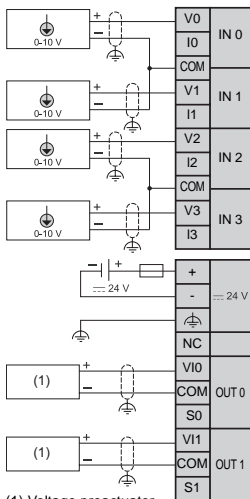

(1) Voltage preactuator  
(2) Current preactuator

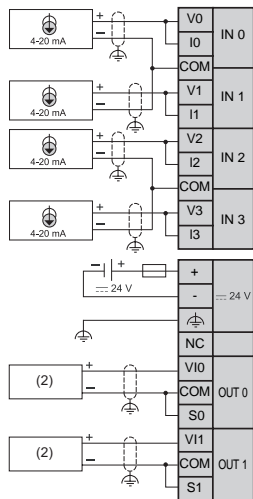

<EXM-AMM6HT>

### IMPORTANT

- The power for the analog module should be supplied separately from the LT. Turn the analog module on before turning the LT on. Wait at least 30 seconds after power-off to restart the external power-supply or it may not operate properly.

### NOTE

- Use the braid supplied with the module to connect the functional ground.
- Connect an appropriate fuse for the applied voltage and current draw, at the position shown in the diagram.
- Do not connect any wiring to unused channels.
- To avoid unintended operation of analog I/Os, the EXM-AMM6HT power supply must be switched off when the PLC module is switched off.

### 15.13 Thermocouple Pt100 input/1-ch analog-output module

The detail of the external power supply is: the rated supply voltage is 24 VDC, the rated input voltage ranges from DC20.4 to 28.8 V. The consumption current is 40 mA\*1 or 50 mA\*2 (24 VDC) when the input is not-open, output 100%.

		EXM-ALM3LT	
Characteristics of Thermocouple & Temperature Inputs		Thermocouple	Temperature Probes
Input Range		Type K: 0 to 1300°C/32 to 2372°F Type J: 0 to 1200°C/32 to 2192°F Type T: 0 to 400°C/32 to 742°F	(RTD) Pt 100, 3-wire type (-100 to 500°C) (-148 to 932°F)
Input Impedance		1 MΩ min.	
A-D Conversion	Sample Repetition Time	20 ms max.	20 ms max.*1 40 ms max.*2
	Total Input System Transfer Time*3	200 ms + 1 scan time*1 60 ms + 1 scan time*2	200 ms + 1 scan time*1 80 ms + 1 scan time*2
	Input Type	Differential input	
	Operating Mode	Self-scan	
	Conversion Mode	ΣΔ type ADC	
Input Error	Maximum Error at 25°C (77°F)	±0.2% of full scale plus reference Junction compensation accuracy ±4°C max	±0.2% of full scale
	Temperature Coefficient	±0.006% of full scale/°C	
	Repeatable after Stabilization Time	±0.5% of full scale	
	Nonlinear	±0.2% of full scale	
	Maximum Error	±1% of full scale	
Data	Digital Resolution	All types: 4,096 increments (12 bits)*1 Type K: 13,000 increments (14 bits)*2 Type J: 12,000 increments (14 bits)*2 Type T: 4,000 increments (12 bits)*2	4,096 increments (12 bits)*1 6,000 increments (13 bits)*2
	Input Value of LSB*4	Type K: 0.325°C/0.585°F*1 Type J: 0.300°C/0.540°F*1 Type T: 0.100°C/0.180°F*1 All types: 0.100°C*2/0.180°F*2	0.15°C/0.27°F*1 0.100°C/0.180°F*2

		EXM-ALM3LT		
Characteristics of Thermocouple & Temperature Inputs		Thermocouple	Temperature Probes	
Data	Data Type in Application Program	Per 0.1 degrees°C (Type K: 0.0 to 1300.0 degrees°C) Per 0.1 degree°F (Type K: 32.0 to 2372.0 degrees°F)		
	Monotonicity	Yes		
	Input Data Out of Range	Detectable *5*6		
Noise Resistance	Maximum Temporary Deviation during Electrical Noise Tests	±3% maximum*1 or ±1% maximum*2 when a 1 kV clamp voltage is applied to the I/O wiring and 1 kV is applied to the power directly.	Accuracy is not assured when noise is applied.	
	Common Mode Characteristics	Common mode reject ratio (CMRR): -50 dB		
	Common Mode Voltage	16 VDC		
	Input Filter	No		
	Crosstalk	2 LSB max.		
Voltage Endurance		500 V between input and power circuit		
Isolation Method		Photocoupler Isolation between input and internal circuit		
Selection of Analog Input Signal Type		Using software programming		
Calibration or Verification to Maintain Rated Accuracy		Approximately 10 years		
Disconnection detection		No		
External Connection		11-pin terminal connector		

\*1 Compatible with models that have revision "PV: 03 RL: 07 SV: 1.2". Please refer to "Revision" on page 5.

\*2 Compatible with models that have revision "PV: 04 RL: 08 SV: 2.0". Please refer to "Revision" on page 5.

\*3 Total input system transfer time = sample repetition × 2 + internal operation time + 1 scan time.

The value is the maximum time.

For Thermocouple,

as for revision "PV: 03 RL: 07 SV: 1.2", Typ 33ms + 1 scan time

as for revision "PV: 04 RL: 08 SV: 2.0", Typ 36.5ms + 1 scan time

For Temperature Probes,

as for revision "PV: 03 RL: 07 SV: 1.2", Typ 43ms + 1 scan time

as for revision "PV: 04 RL: 08 SV: 2.0", Typ 26.5ms + 1 scan time

\*4 The input value per 1 bit is as shown in the table. LT truncates a number to the 2nd decimal places. EX.) LT shows 100.1°C for the value, 100.15°C.

\*5 If the input data is not in the range, the error code RGEF130 (Input data error) is output for the analog module. Once the error occurs, input data from the point of the error is no longer updated. For more information about error codes, read the "Maintenance/Troubleshooting Guide".

\*6 The input value may be regarded as "Input Data Out of Range" due to the maximum error even when it is in the specified input range. Before inputting the value, therefore, consider the maximum error.

Model No.	EXM-ALM3LT	
Analog Output Specifications	Voltage Output	Current Output
Rated Output Voltage Range	From DC0 to 10 V	From DC4 to 20 mA

Model No.		EXM-ALM3LT	
Analog Output Specifications		Voltage Output	Current Output
Load	Load Impedance	2 k $\Omega$ min.*1, 1 k $\Omega$ min.*2	300 $\Omega$ max.
	Application Load Type	Resistive load	
D-A Conversion	Conversion Time	130 ms	
	Total Output System Transfer Time	130 ms + 1 scan time*1 10 ms + 1 scan time*2	
Output Error	Maximum Error at 25°C (77°F)	$\pm 0.2\%$ of full scale	
	Temperature Coefficient	$\pm 0.015\%$ of full scale/°C	
	Repeatable after Stabilization Time	$\pm 0.5\%$ of full scale	
	Output Voltage Drop	$\pm 1\%$ of full scale	-
	Nonlinear	$\pm 0.2\%$ of full scale	
	Output Ripple	1 LSB max.	
	Overshoot	0%	
	Total Error	$\pm 1\%$ of full scale	
Data	Digital Resolution	4,096 increments (12 bits)	
	Output Value of LSB	2.5 mV	4 $\mu$ A
	Data Type in Application Program	0 to 4095 (12 bit data) -32768 to 32767 (optional range designation)*3	
	Monotonicity	Yes	
	Current Loop Open	-	Not detectable
Noise Resistance	Maximum Temporary Deviation during Electrical Noise Tests	$\pm 3\%$ maximum when a 1 kV clamp voltage is applied to the I/O wiring and 1 kV is applied to the power directly.	
	Cable	Twisted-pair shielded cable is recommended for improved noise immunity	
	Crosstalk	No crosstalk because of 1 channel output	
Voltage Endurance		500 V between output and power circuit	
Isolation Method		Photocoupler Isolation between output and internal circuit	
Selection of Analog Output Signal Type		Using software programming	
Calibration or Verification to Maintain Rated Accuracy		Approximately 10 years	
Disconnection detection		No	
External Connection		11-pin terminal connector	

\*1 Compatible with models that have revision "PV: 03 RL: 07 SV: 1.2". Please refer to "Revision" on page 5.

\*2 Compatible with models that have revision "PV: 04 RL: 08 SV: 2.0". Please refer to "Revision" on page 5.

\*3 The 12-bit data (0 to 4095) processed in the Analog I/O module can be linear converted to a value between -32768 and 32767. The optional range designation and analog I/O data minimum and maximum values can be selected using data registers allocated to analog I/O modules.

## ◆ Wiring

□ indicates a fuse.

<EXM-ALM3LT>

### 2-wire cabling:

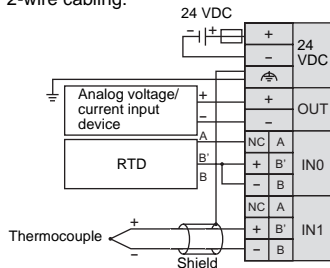

### 3-wire cabling:

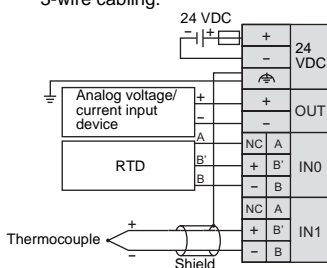

### 4-wire cabling:

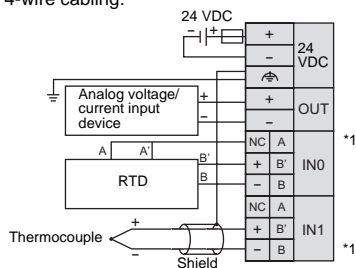

\*1

\*1 For 4-wire cabling, output A' is not connected.

### IMPORTANT

- The power for the analog module should be supplied separately from the LT.
- Turn the analog module on before turning the LT on. Wait at least 30 seconds after power-off to restart the external power-supply or it may not operate properly.
- Be sure the analog IN/OUT lines (especially, Temperature Probes) are placed in a separate duct from high-frequency, live lines such as high-voltage, high-power lines, inverters, etc.

### NOTE

- Connect a fuse appropriate for the applied voltage and current draw, at the position shown in the diagram.
- Do not connect cables to a channel that is not used. When the input is open, an error code (RGEF130 input data error) occurs to the unused channels, then the invalid values are input. Do not map the parameters on the unused channels.
- When connecting an RTD, connect the three wires to terminals A, B', and B of input channel 0 or 1.
- When connecting a thermocouple, connect the two wires to terminals B' and B of input channel 0 or 1.

## 16. Dimensions

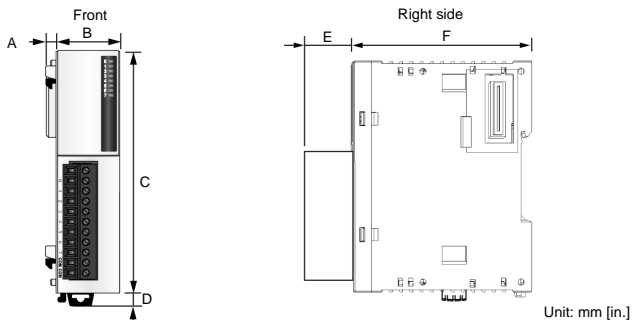

Model No.	A	B	C	D	E	F
EXM-DMM24DRF	3.8 [0.15]	39.1 [1.54]	90 [3.54]	4.5 <sup>*1</sup> [0.18]	1.0 [0.04]	70 [2.76]
EXM-ARI8LT	3.8 [0.15]	39.1 [1.54]	90 [3.54]	4.5 <sup>*1</sup> [0.18]	14.6 [0.57]	70 [2.76]
EXM-DDI16DT EXM-DDI8DT EXM-DRA8RT EXM-DRA16RT EXM-DDO8UT EXM-DDO8TT EXM-DMM8DRT EXM-AMI2HT EXM-ALM3LT EXM-AMM3HT EXM-AMO1HT EXM-AVO2HT EXM-AMI4LT EXM-AMM6HT	3.8 [0.15]	23.5 [0.93]	90 [3.54]	4.5 <sup>*1</sup> [0.18]	14.6 [0.57]	70 [2.76]
EXM-DDO16UK EXM-DDO16TK	3.8 [0.15]	17.6 [0.69]	90 [3.54]	4.5 <sup>*1</sup> [0.18]	11.3 [0.44]	70 [2.76]

\*1 The length of the pulled out hook is 8.5 mm [0.33 in.].

## 17. Installation

### 17.1 Installation requirements

#### IMPORTANT

- Be sure to clamp the I/O cables wired for EX module within 200 mm [7.87 in.] position from the connector to prevent EX module's damage.

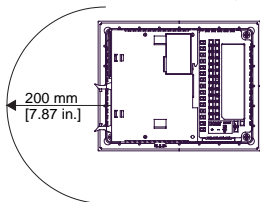

- In order to improve maintenance performance, operability and aeration performance, provide the following amount of space between the LT that mounts the EX module, or the Hybrid Terminal Block (HTB) and other parts or structural objects.

#### Attachment at the rear side of the LT

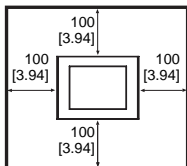
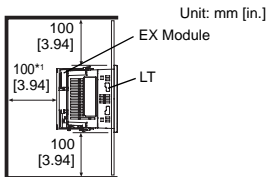

- \*1 As with the LT, provide space (100 mm [3.94 in.]) between the EX module on the rear side of the LT and other structural objects (the EX module as a unit requires 80 mm [3.15 in.] space).

#### Connection to a Hybrid Terminal Block (HTB)

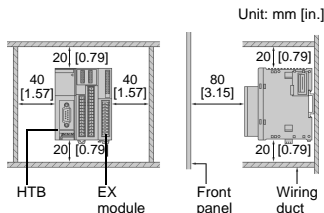

### 17.2 Attachment/Removal

#### Attachment / Removal

- Peel off the label from the EX module interface on the rear side of the LT.

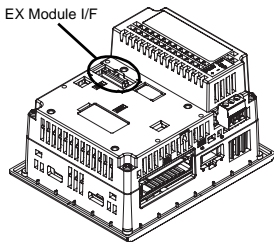

(LT-3200 Series)

- (2) Attach the first EX module to the rear side of the LT.  
Insert the extension connector at the left side of the first EX module to the EX module interface (EXT1) of the LT. Attach the second and third EX modules in a similar manner.

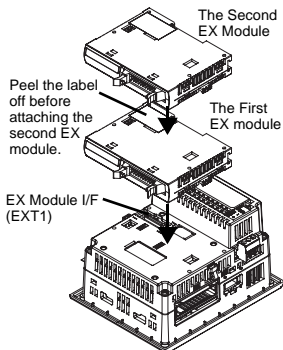

- (3) Push down the latch buttons on the top to secure the EX module to the LT.

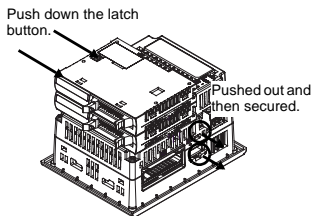

#### IMPORTANT

- Make sure to fix the EX modules to the LT securely using the latch buttons.
- Up to two EX modules can be connected to the rear side of the LT-3200 Series.
- Up to three EX modules can be connected to the rear side of the LT-3300 Series. Only the third EX module

must be fixed with the securing hook attached to the LT

- As for EXM-DMM24DRF and EXM-ARI8LT, only one EX module can be connected to an LT.

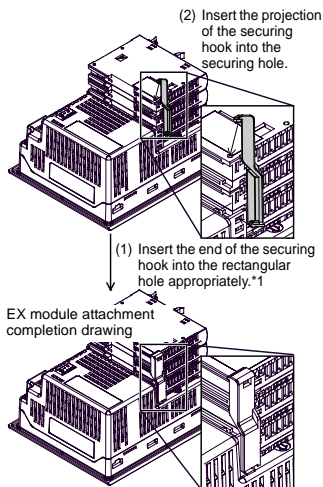

\*1 Before the insertion step, determine the position of the rectangular hole. The appropriate position varies depending on the combination of the EX modules that you use.

#### ■ Removal

- (1) To remove the EX module, push up the latch buttons to unlock it.  
Latch buttons released when pushed out

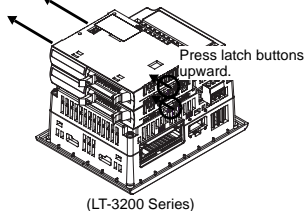



## 17.3 Mounting to / Removal from a DIN rail

### NOTE

- Use a DIN rail when connecting the EX module to a HTB.

### ■ Attachment

Put the upper groove of the unit on the upper edge of the DIN rail. Push the lower side of the unit to the lower edge of the DIN rail unit it clicks.

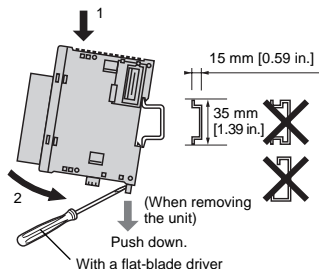

### ■ Removal

While pushing down the hook in the direction of the arrow with a flat-blade driver, pull the lower side of the unit and remove the unit from the DIN rail.

### IMPORTANT

- Check the vertical direction of the unit. Attach the unit on to the vertical plane properly. Improper mounting of the unit may prevent heat release and proper operation of the unit.
- The unit release hooks are kept open when not used. Make sure that the unit release hooks close properly and the unit is firmly fixed on the DIN rail.

## 18. Wiring

### ⚠ WARNING

- To avoid an electric shock, prior to connecting this unit's power cord terminals to the power supply screw terminal block, confirm that this unit's power supply is completely turned OFF, via a breaker, or similar unit.
- Any other power level can damage both this unit and the power supply.
- When the FG terminal is connected, be sure the wire is grounded.

### IMPORTANT

- Make sure to remove the connectors from this unit first, then connect cables to the terminal. Failure to do so may cause an electric shock.

### 18.1 Power Supply and FG Terminal

### NOTE

- This power supply and FG terminal are mounted to the EXM-ARI8LT.

### ■ Power Cord Cable Specification

Use copper conductors only.

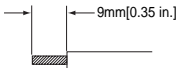
Power Cord Diameter	0.75 to 1.3 mm <sup>2</sup> (18 - 16 AWG)
Conductor type	Stranded Wire *1
Conductor Length	

\*1 If the conductor's end (individual) wires are not twisted correctly, the end wires may either short against each other, or against an electrode.

Use the following items when performing wiring. Items are made by Phoenix Contact.

Recommended Driver	SZS 0,4X2,5 (1205037)
Recommended Pin Terminals	AI 1,5-8 BK (3200043) (For FG only) AI 1-8 RD(3200030) AI-TWIN2X0,75-8 GY (3200807) AI 0,5-8 WH(3200014) AI-TWIN2X0,5-8 WH (3200933)
Recommended Pin Terminal Crimp Tool	CRIMPFOX ZA 3 (1201882)

## ■ Power Cord Cable Connection

- (1) Confirm that the power cord of the unit, connected the EX module, is unplugged from the power supply.
- (2) Loosen the screw of the terminal connector to which the power cord cable is connected.



- (3) Strip the power cord cable and twist the core of the power cord cable. Insert it into the pin terminal and crimp the terminal. Attach the terminal to the terminal connector.
- (4) Fasten the screw of the terminal connector to secure the power cord cable.

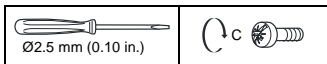

### IMPORTANT

- The torque required to tighten these screws is 0.22 to 0.25N•m.
  - Do not solder the cable connection.
- (5) Insert the connector, which the power cord cable is connected to, into the terminal block.

## ■ Connection of the Functional Ground Screw

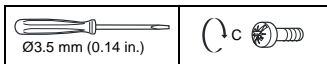

### IMPORTANT

- The torque required to tighten the screw is 0.5N•m.

## 18.2 Terminal Connector

### NOTE

- Models that have interfaces to the terminal connector are as follows:

10 pin connector compatible models:

EXM-DDI8DT	EXM-DDO8TT
EXM-DDI16DT	EXM-DRA16RT
EXM-DDO8UT	EXM-AMM6HT

11 pin connector compatible models:

EXM-DRA8RT	EXM-AMO1HT
EXM-DMM8DRT	EXM-AMM3HT
EXM-AMI2HT	EXM-ALM3LT
EXM-AVO2HT	EXM-AMI4LT

13 pin connector compatible model:

EXM-ARI8LT

### I/O Cable Specification

I/O Cable Diameter	0.20 to 1.31 mm <sup>2</sup> (24 - 16 AWG)
Cable length in compliance with electromagnetic immunity	3 m (max.)
Conductor Type	Simple or Twisted Wire*1

\*1 If the conductor's end (individual) wires are not twisted correctly, the end wires may either short against each other, or against an electrode.

### NOTE

- Terminal connector is CA6-EXMCNRS10P-01(10 pins)/CA6-EXMCNRS11P-01(11 pins) from Pro-face, or MC1,5/10-ST-3,5(10 pins)/MC1,5/11-ST-3,5(11 pins) from PHOENIX CONTACT.

Use the following items when performing wiring. Items are made by Phoenix Contact.

Recommended Driver	SZS 0,4X2,5 (1205037)
Recommended Pin Terminals	AI 1,5-8 BK (3200043) (For FG only) AI 1-8 RD(3200030) AI-TWIN2X0,75-8 GY (3200807) AI 0,5-8 WH(3200014) AI-TWIN2X0,5-8 WH (3200933)
Recommended Pin Terminal Crimp Tool	CRIMPFOX ZA 3 (1201882)

### I/O Cable Connection

- Confirm that the power cord of the unit, connected the EX module, is unplugged from the power supply.
- Loosen the screw of the terminal connector to which the I/O cable is connected.

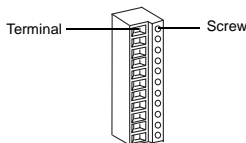

- Strip the I/O cable and twist the core of the I/O cable. Insert it into the pin terminal and crimp the terminal. Attach the terminal to the terminal connector.
- Fasten the screw of the terminal connector to secure the I/O cable.

### IMPORTANT

- Use a flat-blade screwdriver (Size 0.4 × 2.5) to tighten the terminal screws. The torque required to tighten these screws is 0.22 to 0.25N•m.
- Do not solder the cable connection.

- (5) Insert the terminal connector, which the I/O cable is connected to, into the terminal block.

**NOTE**

- The terminal connector withstands insertion and removal more than 100 times.

### 18.3 MIL Connector

**NOTE**

- Models that have MIL connector interfaces are as follows:

EXM-DDO16UK

EXM-DDO16TK

#### ■ I/O Cable Specifications

I/O Cable Diameter	0.08 mm <sup>2</sup> (28 AWG)
Cable length in compliance with electromagnetic immunity	3 m (max.)

**NOTE**

- MIL connector from Oki Electric Cable Co., Ltd. FL20A2F0 is recommended.

### 18.4 Terminal Block (nonremoval)

**NOTE**

- This terminal block is mounted to the EXM-DMM24DRF and cannot be removed.

#### ■ I/O Cable Specifications

I/O Cable Diameter	0.5 to 1.0 mm <sup>2</sup> (20 - 18 AWG)
Cable length in compliance with electromagnetic immunity	3 m (max.)

#### ■ I/O Cable Connection

- (1) Confirm that the power cord of the unit, connected the EX module, is unplugged from the power supply.
- (2) Push in the plate next to the terminal with a flat-blade screwdriver (size: 2.5 x 0.4 mm).
- (3) The terminal opens. Insert the stripped I/O cable. Release the flat-blade screwdriver to allow the terminal to clamp the I/O cable.

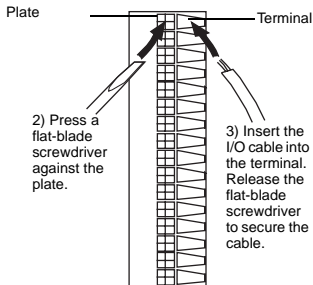

### 18.5 Wiring Precaution

- To help prevent noise and interference problems, separate all control, communication and power lines by placing them in a separate ducts.

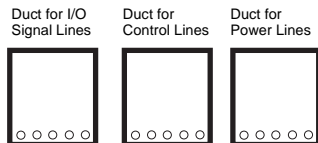

If different wires must be placed in the same duct, separate them with an earthed/grounded divider.

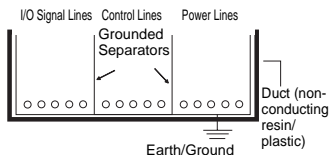

#### NOTE

- If the lines cannot be separated, use shielded lines and create a ground from the shield line.

#### IMPORTANT

- Use noise-reducing external wiring methods to increase overall system reliability.
- To prevent power surges or noise interference, use ducts to separate all DC I/O or current circuit wires from communication cables.
- To prevent malfunctions due to noise, communication cables must be wired separately from high-frequency lines and power lines such as high-voltage lines, high-current lines, and inverters.