

Preface

Thank you for purchasing the DVI Input unit for GP3000 series, "GP3000-DVI01" (hereafter referred to as the "DVI Input unit").

This unit is intended for use with expansion unit interface of the Pro-face's

GP3000 series^{*1} programmable operator interface (hereafter referred to as the "GP"), and as a DVI input interface with any of the above mentioned GPs.

Before actually beginning to use the DVI Input unit, please be sure to read through this manual and other related manuals to fully understand all the settings and functions.

^{*1} For the compatible models, please refer to the following.

SEE→ *Applicable Products (page5)*

NOTICE

1. Copying this manual's contents, either in whole or in part, is prohibited without the express permission of Digital Electronics Corporation, Japan.
2. The information contained in this manual is subject to change without notice.
3. If you find any errors or omissions in this document, please contact Digital Electronics Corporation to report your findings.
4. Please be aware that Digital Electronics Corporation shall not be held liable by the user for any damages, losses, or third party claims arising from the uses of this product.

© 2008 Digital Electronics Corporation. All rights reserved.





Product names used in this manual are the trademarks / registered trademarks of their respective owners.

Essential Safety Precautions



All safety-related procedures stated in this document must be followed to operate the DVI Input unit correctly and safely. Be sure to read this and any related documents thoroughly to understand the correct operation and functions of the DVI Input unit.

Safety Icons

Throughout this manual, these icons provide essential safety information for DVI Input unit operation procedures requiring special attention. These icons indicate the following levels of danger:

 WARNING	Indicates situations where severe bodily injury, death or major equipment damage can occur.
 CAUTION	Indicates situations where slight bodily injury or minor equipment damage can occur.
	Indicates actions or procedures that should NOT be performed.
	Indicates actions or procedures that MUST be performed to ensure correct unit operation.

WARNING

-  Due to the possibility of an electrical shock, be sure that the power supply for the GP is not plugged in when installing the DVI Input unit.
-  Be sure to design your system so that a communication fault between GP and external device (PLC etc.) will not cause equipment to malfunction. This is to prevent any possibility of bodily injury or equipment damage.
-  Do not modify the DVI Input unit. Doing so may cause a fire or an electric shock.

CAUTION

General Safety Precautions

-  Do not allow water, liquids, or metal particles to enter into the DVI Input unit's case, otherwise it can cause a malfunction or electrical shock.

- ⊘ Avoid storing or operating the DVI Input unit in locations where it will be exposed to direct sunlight, high temperature, excessive dust, or vibration.
- ⊘ Avoid storing or operating the DVI Input unit in locations where it would be exposed to excessive temperature and dew condensation happens.
- ⊘ Do not store or operate the DVI Input unit where chemicals or acids are stored, or where high concentrations of fumes are present.
- ⊘ Because the DVI Input unit is a precision instrument, do not store or operate it in locations where something may strike or hit the unit.
- ⊘ Do not use paint thinner or organic solvents to clean the outside of the DVI Input unit. Instead, soak a soft cloth in a diluted neutral detergent, wring it tightly, and then wipe the unit's outside case.

Unit Disposal



- ❗ When the product is disposed of, it should be treated as industrial waste products. Therefore, you are requested to obey the disposal standards or regulations of your country.

Usage Precautions

- When using RGB signal input, a blue-background screen may appear momentarily while the screen is adjusted or when a PC screen is switched. This phenomenon is normal and the DVI Input unit is not malfunctioning.
- With some types of RGB signals, the displayed images or RGB output images may contain noise or may be blurred during the screen adjustment. It is possible that these problems may not be able to be fixed, given the DVI Input unit's available range of adjustment.
- When images are input at other than the supported resolution or refresh rate, a blue-background screen appears.
- Image quality may vary depending on the display size selected.
- The screen display cannot be enlarged or reduced. It is shown at the resolution entered.

Information Symbols

This manual uses the following icons:

	Indicates a warning or a product limitation. Be sure to follow the instructions given with this icon to ensure the safe operation of the DVI Input unit.
	Contains additional or useful information.
(1) (2)	Indicates steps used to accomplish a given task. Be sure to follow these steps in the order they are written.
*1	Indicates useful or important supplemental information.
	Indicates pages containing related information.
GP-Pro EX	Indicates the Screen editor program for Pro-face's GP3000 series.

Package Contents

DVI Input Unit (1)

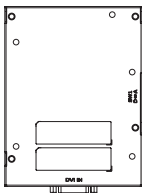

Hardware Manual <This Manual> (1)

Warning/Caution Information (1)

Screws (4)

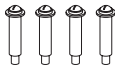

This unit has been carefully packed, with special attention to quality. However, should you find anything damaged or missing, please contact your local distributor immediately for service.

Applicable Products

■ Applicable Units

GP3000 Series	AGP-35*0T, AGP-36*0T, AGP-37*0T
---------------	---------------------------------

■ Applicable Software

GP3000 Series	GP-Pro EX Ver. 2.20 or later * ¹
---------------	---

IMPORTANT

- For GP3000 Series, GP-Pro EX Ver. 2.20 or later *¹ is required to utilize the DVI Input unit's features. If you are currently using an earlier version of the above software, you will need to upgrade. For information, contact your local Pro-face distributor.

*¹The software version information can be found at the Help pull-down menu's Version Information selection.

Inquiry

Do you have any questions about difficulties with this product ?
Please access our site anytime that you need help with a solution.

<http://www.pro-face.com/otasuke/>

UL/c-UL Approval

The DVI Input unit "GP3000-DVI01" is a UL/c-UL product, listed on UL File No.E220851 and UL File No.E210412.

The DVI Input unit "GP3000-DVI01" is a UL/c-UL product, recognized on UL File No.E171486 and UL File No.E231702.

Product Model No.	UL/c-UL Registration Model No.
GP3000-DVI01	3610001

This product conforms to the following standards:

- UL508
Standard for Industrial Control Equipment

- UL60950-1
Information Technology Equipment - Safety - Part 1
- ANSI/ISA-12.12.01-2000
Nonincendive Electrical Equipment for Use in Class I and II, Division 2 and Class III, Division 1 and 2 Hazardous (classified) Locations.

<Cautions>

Be aware of the following items when building the GP into an end-use product:

- Be sure that the unit is installed so that it is at least 100 mm away from any adjacent structures or devices. If these requirements are not met, the heat generated by the unit's internal components may cause the unit to fail to meet UL standard requirements.
- For use with the following models only: Models 3280024-02, -14; 3280035-41.
- For use with the following models only: Models 3280024-01, -11, -13; 3280035-45, -75; 3581301-01, -03.

<ANSI/ISA-12.12.01-2000 - Compliance and Handling Cautions>

- Suitable for use in Class I, Division 2, Groups A, B, C, and D Hazardous Locations, or Non-Hazardous Locations.
- WARNING: Explosion hazard - substitution of components may impair suitability for Class I, Division 2.
- WARNING: Explosion hazard - when in hazardous locations, turn off power before replacing or wiring modules.
- WARNING: Explosion hazard - do not disconnect equipment unless power has been switched off or the area is known to be non-hazardous.

CE Marking

The DVI Input unit "GP3000-DVI01" is CE marked product that conforms to EMC directives, EN55011 Class A and EN61000-6-2.

Contents

Preface	1
Essential Safety Precautions	2
Information Symbols	4
Package Contents	4
Applicable Products	5
Inquiry	5
UL/c-UL Approval	5
CE Marking	6
Contents	7
Chapter 1 General	
1.1 Operating the DVI Input Unit.....	8
1.2 System Configuration	8
1.2.1 Connection Configuration Diagram	8
1.3 Parts Name and Functions	9
1.4 Accessories	10
1.5 Software.....	10
Chapter 2 Specifications	
2.1 General Specifications	11
2.1.1 Electrical	11
2.1.2 Environmental.....	11
2.1.3 Structural	12
2.2 External Interface.....	13
2.2.1 DVI-I Interface	13
2.3 External Views and Dimensions	17
2.3.1 External Views.....	17
2.3.2 GP-3500 Series External Views with DVI Input Unit	18
2.3.3 GP-3600 Series External Views with DVI Input Unit	19
2.3.4 GP-3700 Series External Views with DVI Input Unit	20
Chapter 3 Installation	
3.1 Installing the DVI Input Unit	21
3.2 Wiring for DVI Input	23
3.2.1 DVI cable connection	23
Chapter 4 Setup	
4.1 DVI-A Display Adjustment	24

Chapter 1 General

1.1 Operating the DVI Input Unit

The DVI Input unit which is installed on the GP and cable-connected with a Host Unit enables the GP to display the images on the Host (digital / analog RGB).

1.2 System Configuration

1.2.1 Connection Configuration Diagram

An example of connections for an entire DVI Input system is illustrated below.

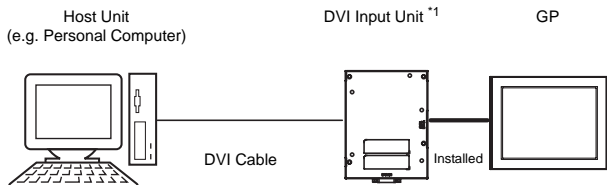

*1 The Expansion Unit Interface 1 (EXT1) cannot connect an expansion unit when the DVI Input unit is connected to the AGP-35*0T.

1.3 Parts Name and Functions

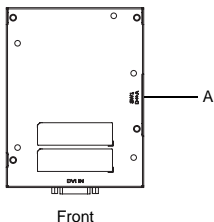

A. SW1
Switch for selecting a connector connected to the DVI IN port. Select 'D' when connecting a DVI-D or DVI-I connector. Select 'A' when connecting a DVI-A (analog RGB) connector.

B. GP connector
Connector for connection to a expansion unit interface of a GP unit.

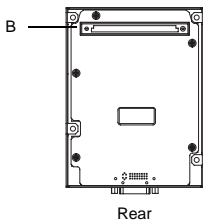

C. DVI IN
Image signal input connector.

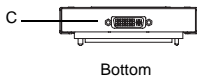

1.4 Accessories

■ Cables

Product Name	Model No.	Description
DVI-D Cable	FP-DV01-50 FP-DV01-100 ^{*1}	Digital Visual Interface cable used to send image signals from the host to the GP. DVI1.0 compliant (DVI-D 24-pin plug). (5 m or 10 m)
DVI-I - RGB Conversion Cable	CA7-CBLCVRGB-01	A cable converting DVI-A to RGB

*1 The FP-DV01-100 can be used only when the connected host is a PS-2000B unit. When using the FP-DV01-100, be sure to turn the PS-2000B's internal DIP switch 4 ON. When using the FP-DV01-50, turn this switch OFF.

1.5 Software

DVI Input unit is compatible for GP-Pro EX Ver. 2.20 or later. Depending on your software version, it is necessary to download the latest module and install the additional programs.

For details, please access Pro-face's site that offers support for Pro-face products.

<http://www.pro-face.com/otasuke/>

Refer to "GP-Pro EX Reference Manual" for the details including display settings for the input image window.

Chapter 2 Specifications

2.1 General Specifications

2.1.1 Electrical

Items		Specifications
Power Supply	Rated Voltage	DC5V \pm 5%(supplied by the GP unit)
	Power Consumption	DC5V 0.7A or less (TYP 0.65A)
Voltage Endurance		When the GP is DC type: AC1000V 20mA for 1 minute (between charging and FG terminals) When the GP is AC type: AC1500V 20mA for 1 minute (between charging and FG terminals)
Insulation Resistance		DC500V 10M Ω (min.) (between charging and FG terminals)

2.1.2 Environmental

Items		Specifications
Physical	Surrounding Air Temperature	0°C to 50°C
	Storage Temperature	-20°C to +60°C
	Ambient Humidity	10%RH to 90%RH (Wet bulb temperature: 39°C max. - no condensation.)
	Storage Humidity	10%RH to 90%RH (Wet bulb temperature: 39°C max. - no condensation.)
	Dust	0.1mg/m ³ and below (non-conductive levels)
	Pollution Degree	For use in Pollution Degree 2 environment
	Atmosphere	Free of corrosive gases
	Air Pressure Vibration Resistance (availment altitude)	800 to 1114hPa (2,000 meters above sea-level and below)

Mechanical	Vibration Resistance	IEC61131-2 compliant 5 to 9Hz single-amplitude 3.5mm 9 to 150Hz constant-accelerated velocity 9.8m/s ² X,Y,Z directions for 10 cycles (100 minute)
	Concussion Resistance	IEC61131-2 compliant (147m/s ² X, Y, Z directions for 3 times)
Electrical	Noise Immunity (via noise simulator)	Noise Voltage: 1000V _{p-p} (GP:DC type) 1500V _{p-p} (GP:AC type) Pulse Duration: 1μs Rise Time: 1ns
	Electrostatic Discharge Immunity	Contact Electrical Discharge 6kV (complies with IEC61000-4-2 Level 3)

2.1.3 Structural

Items		Specifications
Installation	Installation method	Screw fixing
	Cooling Method	Natural air circulation
	Weight	Approx. 400g [0.88lb] or less
	External Dimensions	W110mm [4.33in.] x H144mm [5.67in.] x D21.1mm [0.83in.] (excluding projection and connector part)

2.2 External Interface

2.2.1 DVI-I Interface

■ Input Video Signal Specification

Items	Specifications	Remarks
Input Signal Type	VESA standard Analog RGB, separated (DVI-A analog RGB interface) TMDS standard Digital RGB (DVI-D interface)	-
Maximum Transmission Distance	5m or less recommended (10m when connected to a PS-2000B unit with DVI-D interface ^{*1})	It varies depending on the performance of the PC connected.
Resolution	See "Available Number of Dots (pixels) Displayed". (SEE→) ■ Available Number of Dots (pixels) Displayed (page 14)	-
Color Signal	0.7V _{p-p} , Positive polarity (TYP) Input range: 0.5 to 1.0V _{p-p} , Positive polarity (DVI-A analog RGB interface)	75Ω termination resistor
H Sync.	TTL level, positive true / negative true	Signal polarity is determined automatically.
V Sync.	TTL level, positive true / negative true	Signal polarity is determined automatically.

^{*1} The PS-2000B unit settings need to be changed.

■ Available Number of Dots (pixels) Displayed

Mode	Horizontal Resolution	Vertical Resolution	H Sync. (kHz)	V Sync. (Hz)	Dot Clock (MHz)
VGA	640	480	31.469	59.940	25.175
	640	480	37.861	72.809	31.500
	640	480	37.500	75.000	31.500
	640	480	43.269	85.008	36.000
SVGA	800	600	35.156	56.250	36.000
	800	600	37.879	60.317	40.000
	800	600	48.077	72.188	50.000
	800	600	46.875	75.000	49.500
	800	600	53.674	85.061	56.250
XGA	1024	768	48.363	60.004	65.000
	1024	768	56.476	70.069	75.000
	1024	768	60.023	75.029	78.750

■ DVI-I Interface Pin Assignments

Pin No.	Signal Name	Condition	Pin Location
1	RX2-	T.M.D.S. Data2-	
2	RX2+	T.M.D.S. Data2+	
3	GND	T.M.D.S. Data2/4 Shield	
4	NC	Unused	
5	NC	Unused	
6	DDCSCL	DDC Clock	
7	DDCSDA	DDC Data	
8	VSYNC	Analog Vsync	
9	RX1-	T.M.D.S. Data1-	
10	RX1+	T.M.D.S. Data1+	
11	GND	T.M.D.S. Data1/3 Shield	
12	NC	Unused	
13	NC	Unused	
14	+5V_DVI	+5V Power Supply for DDC	
15	GND	Ground	
16	HPD	Hot Plug Detect	
17	RX0-	T.M.D.S. Data0-	
18	RX0+	T.M.D.S. Data0+	
19	GND	Ground	
20	NC	Unused	
21	NC	Unused	
22	GND	T.M.D.S. Clock Shield	
23	RXC+	T.M.D.S. Clock+	
24	RXC-	T.M.D.S. Clock-	
C1	RIN	Analog R	
C2	GIN	Analog G	
C3	BIN	Analog B	
C4	HSYNC	Analog Hsync	
C5	GND	Analog Grounding	

IMPORTANT

- Connect the cables before starting up the PC and the GP. To prevent a possible equipment malfunction, do not disconnect the cable while the equipment is turned ON.
- The screen display cannot be enlarged or reduced. When inputting an image with higher resolution than the GP's resolution, only a part of the screen display is shown. When inputting an image with lower resolution than the GP's resolution, the GP's screen is shown around the screen display.
- If a cable other than the specified Pro-face's DVI-D cable is used, product performance cannot be guaranteed due to the possibility of noise interfering with the FP unit's operation.
- The FP-DV01-100 can be used only when the connected host is a PS-2000B unit. When using the FP-DV01-100, be sure to turn the PS-2000B's internal DIP switch 4 ON. Display resolution for FP-DV01-100 is 1024 × 768 (XGA) only. (When using the FP-DV01-50, turn this switch OFF.)

2.3 External Views and Dimensions

2.3.1 External Views

Unit: mm [in.]

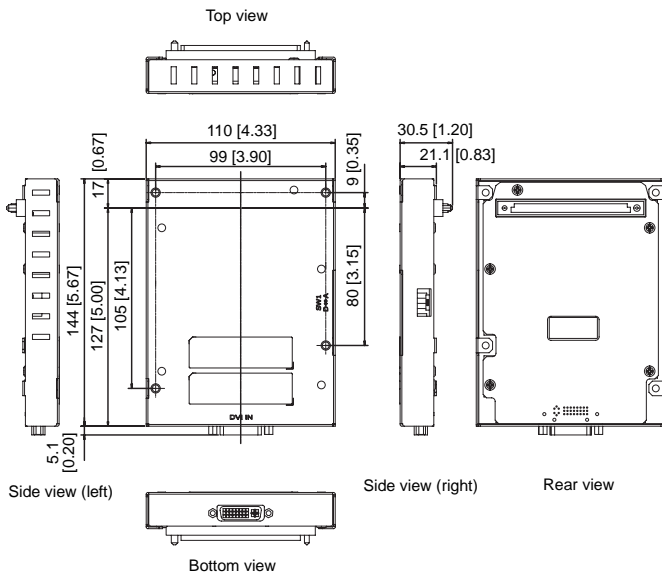

2.3.2 GP-3500 Series External Views with DVI Input Unit

Unit: mm [in.]

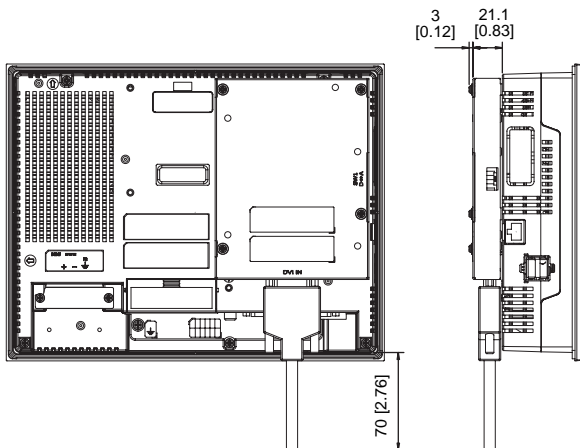
**NOTE**

- When you design the system, be sure to consider the cable material and the lead-out direction so that no excessive force is applied to the cable.

IMPORTANT

- All the above values are designed in case of cable bending. The dimensions given here are representative values depending on the type of connection cable used. Therefore, they are all intended for reference only.
- Be sure to design your system so that after the GP unit is installed there is sufficient space for the DVI Input unit's connectors and cable routing.
- When installing or removing the GP unit while its connectors attached, be sure not to damage any of the connectors.

2.3.3 GP-3600 Series External Views with DVI Input Unit

Unit: mm [in.]

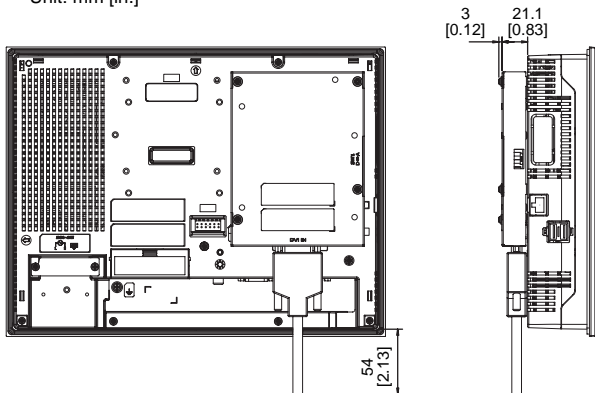

NOTE

- When you design the system, be sure to consider the cable material and the lead-out direction so that no excessive force is applied to the cable.

IMPORTANT

- All the above values are designed in case of cable bending. The dimensions given here are representative values depending on the type of connection cable used. Therefore, they are all intended for reference only.
- Be sure to design your system so that after the GP unit is installed there is sufficient space for the DVI Input unit's connectors and cable routing.
- When installing or removing the GP unit while its connectors attached, be sure not to damage any of the connectors.

2.3.4 GP-3700 Series External Views with DVI Input Unit

Unit: mm [in.]

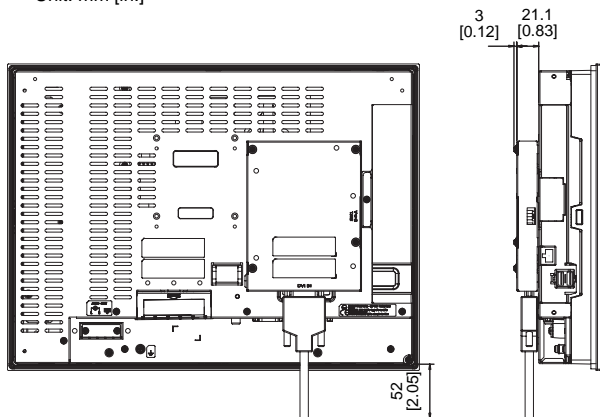
**NOTE**

- When you design the system, be sure to consider the cable material and the lead-out direction so that no excessive force is applied to the cable.

IMPORTANT

- All the above values are designed in case of cable bending. The dimensions given here are representative values depending on the type of connection cable used. Therefore, they are all intended for reference only.
- Be sure to design your system so that after the GP unit is installed there is sufficient space for the DVI Input unit's connectors and cable routing.
- When installing or removing the GP unit while its connectors attached, be sure not to damage any of the connectors.

Chapter 3 Installation

3.1 Installing the DVI Input Unit

⚠ WARNING

- ❗ Due to the possibility of an electrical shock before installation, be sure the GP's power cord is not plugged in to the power supply.

The following figure describes how to install the DVI Input unit into an AGP-3550T.

- (1) Disconnect the power cable and place the GP face down on a flat horizontal surface.
- (2) Insert the GP connector of the DVI Input unit into the Expansion Unit interface on the rear of GP.

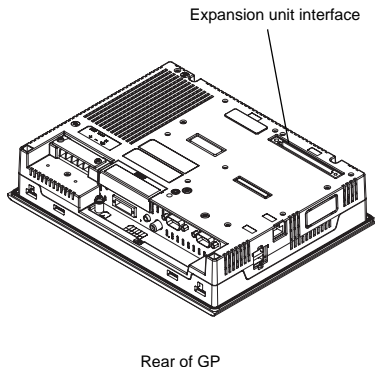

- (3) Fix the DVI Input unit by four screws provided on DVI Input unit. (Tightening torque: 0.5 to 0.6 N•m)

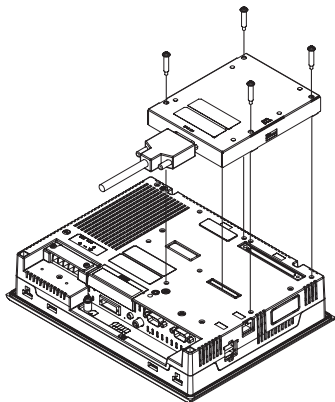
**IMPORTANT**

- The Expansion Unit Interface 1 (EXT1) cannot connect an expansion unit when the DVI Input unit is connected to the AGP-35*0T.
- Because of the attaching screws' structure, there may be a gap between the screw heads and the DVI Input unit even when the DVI Input unit is securely fixed. Tightening the screws with too much force can damage their heads. Use the designated torque to tighten the screws.

3.2 Wiring for DVI Input

3.2.1 DVI cable connection

- (1) Be sure to confirm that power is not supplied to the GP and to the personal computer.
- (2) Connect the DVI connector to the DVI IN port. Tighten the screws to secure the connector.

IMPORTANT

- Connect the cables before starting up the PC and the GP. To prevent a possible equipment malfunction, do not disconnect the cable while the equipment is turned ON.
- Use a DVI cable with connector of 16mm (0.63 in.) or less in thickness. A DVI cable with connector of more than 16 mm (0.63 in.) in thickness interferes with the GP, and therefore, cannot be connected.

Chapter 4 Setup

4.1 DVI-A Display Adjustment

When the image input into the DVI IN port is DVI-A (analog RGB), the GP allows you to adjust the position, display and color.

Refer to “Maintenance / Troubleshooting” of GP-Pro EX for the setup procedures.