

Bus Conversion Unit

Installation Guide

(for GP2000/PS Series Units)

Thank you for purchasing Digital's Bus Conversion Unit (PSL-CONV00), hereafter referred to as the "Unit". This Unit allows the attachment of GP70/77R series expansion units to GP2000/PS Series units.

This manual provides an overview of this Unit, as well as procedures to follow when installing it in the User's system. Be sure to read all this important information carefully prior to using this Unit.

This product is not CE marked or UL/c-UL(CSA) compliant. Therefore, be aware that when it is used in combination with a product that is CE marked and UL/c-UL(CSA) compliant, the marked and compliant product will lose its conformance with these standards.

Safety Precautions

This guide includes information that must be followed to ensure the correct and safe use of this product. Be sure to read both this guide and any related manuals to thoroughly understand the correct operation and functions of both the Bus Conversion Unit and the GP2000/PS Series units.

■ Usage of Safety Icons

Throughout this manual the following icons are shown near procedures requiring special attention to safety. The information given below these icons contains essential safety information.

The following examples explain the meaning of each safety icon:



WARNING

Indicates situations where severe bodily injury, death or major machine damage can occur.



CAUTION

Indicates situations where slight bodily injury or machine damage can occur.



WARNINGS

- When attaching this unit to a GP2000/PS Series unit, make sure that the GP/PS's power cord is not connected to the main power (constant), to prevent an electric shock.
- Do not modify this Unit in any way, since an electric shock or fire may occur.
- Do not use this Unit in areas where flammable gas is present, since an explosion may occur.
- Do not allow water, liquid or metallic objects to enter into the Unit, since they can cause either a malfunction or an electric shock.

To prevent this unit from malfunctioning :

- Be sure the Unit is operated in an environment that is within the unit's designated temperature range.
- Do not operate or store this unit in an environment where it will be exposed to high temperatures.
- Do not operate or store this unit in an environment where it will be exposed to direct sunlight or excessive amounts of dust.
- Since this unit is a precision instrument, do not install it where strong impacts or vibration will occur.
- Do not operate or store this unit in an environment where it may be exposed to chemical vapors or fumes.

Package Contents

The following items are included in the Unit's package. Prior to using the Unit, be sure to confirm that all the items shown below are present.

■ **Bus Conversion Unit
(PSL-CONV00)**

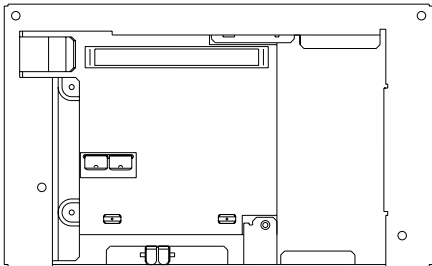

■ **Bus Conversion Unit
Installation Guide (1)
(this document)**

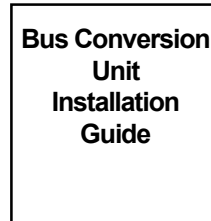

■ **Attachment Screws (4)**

This unit has been carefully packed with special attention to quality. However, should you find anything damaged or missing, please contact your local GP2000/PS Series unit distributor immediately.

1 Dimensions

The Unit's external dimensions are given below.

Unit: mm [in.]

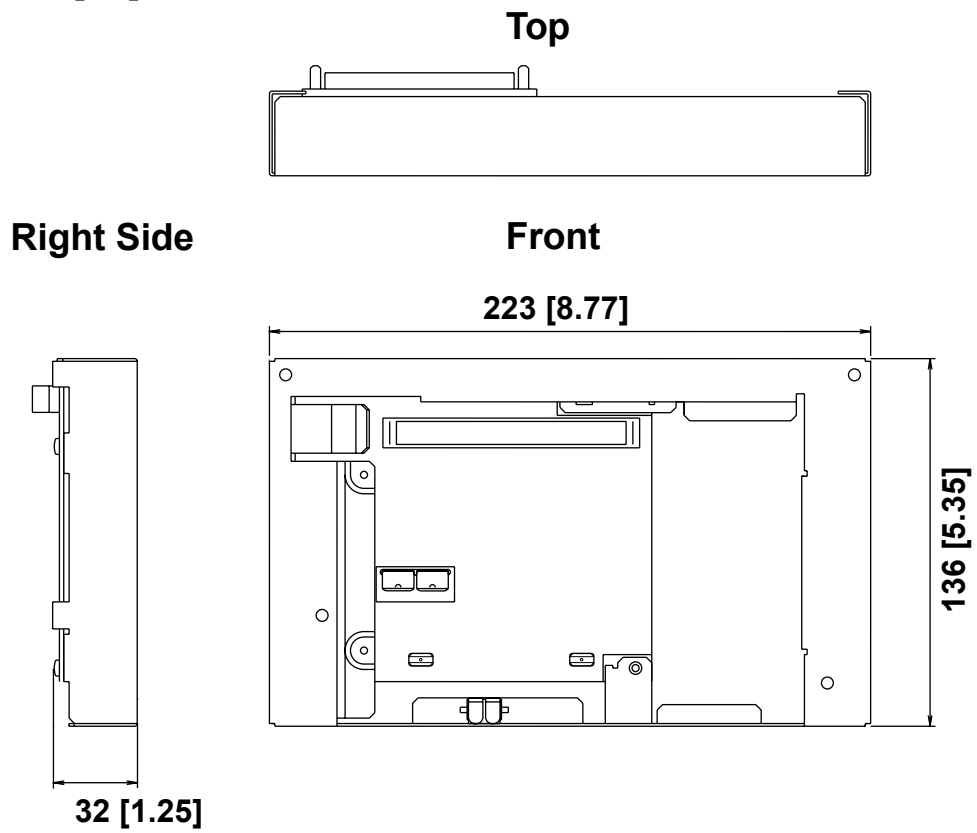

The figures below show the Bus Conversion Unit and an expansion unit attached to a GP2000 Series unit.

Unit: mm [in.]

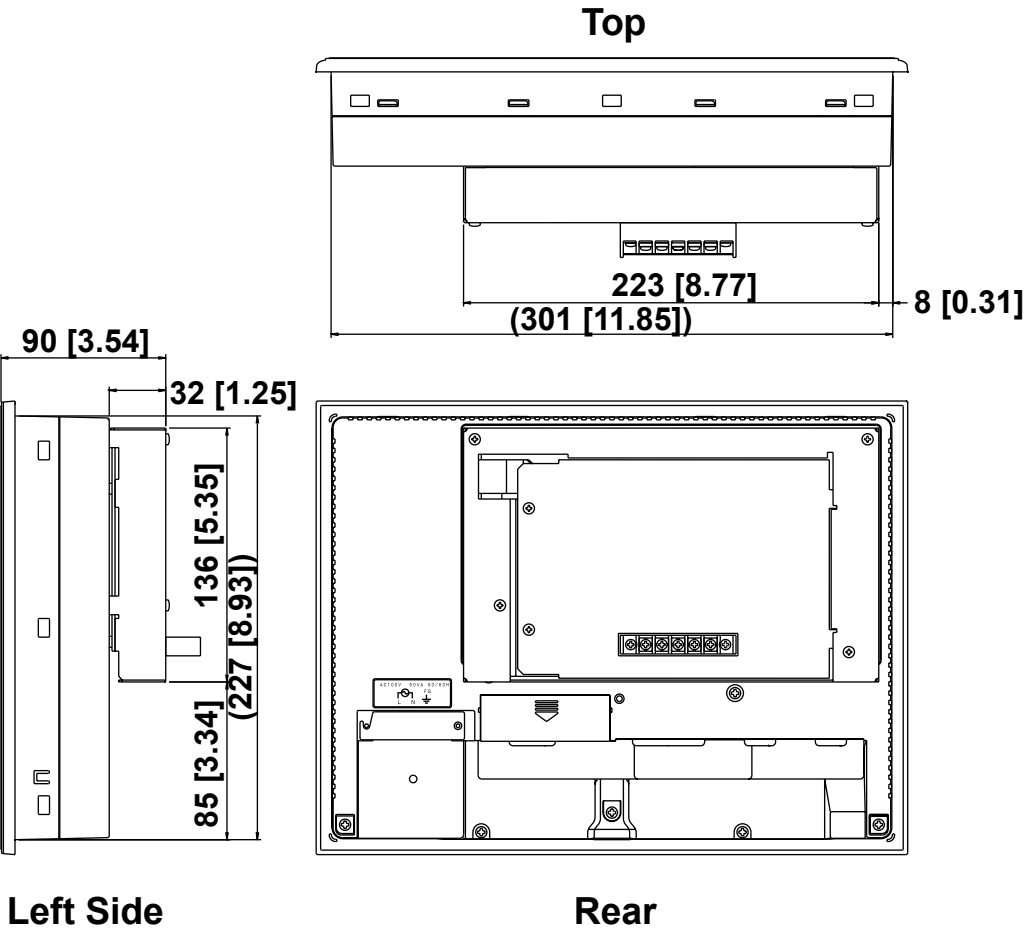

2 Part Name and Function

The Unit's part name and its function are explained below.

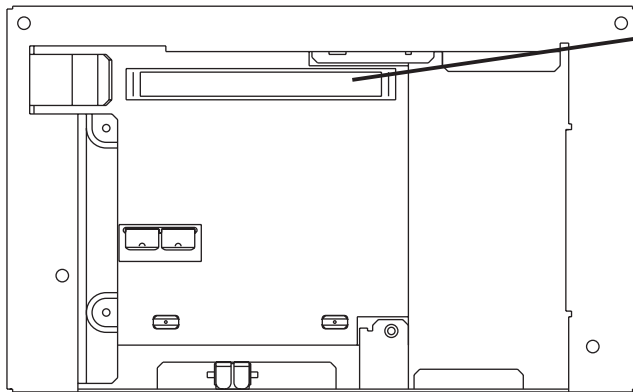

Expansion Bus Connector

Used to connect GP70/77R series expansion units.

3 General Specifications

■ Environmental

Operating Temperature	0 °C to 50 °C
Storage Temperature	-20 °C to 60 °C
Humidity	10%RH to 90%RH (no condensation)
Vibration Resistance	based on JIS B 3501, IEC1131-2 (intermittent vibration) 10Hz to 57Hz 0.075mm 57Hz to 150Hz 9.8m/s ² (continuous vibration) 10Hz to 57Hz 0.035mm 57Hz to 150Hz 4.98m/s ² X, Y, and Z directions for 10 times each (80min.)
Corrosive Gas	Free of corrosive gas

■ Structural

External Dimensions	W223 [87.8] x H136 [53.5] x D32 [1.26] mm [in.] (Main unit only - excluding projections)
Weight	approx. 500g (1.10lb.)

4 Installation

Use the following procedures to install the Bus Conversion Unit in a GP2000/PS Series unit.

WARNINGS

Prior to installing this Unit:

- When attaching this unit to the GP2000/PS Series units, make sure that the GP/PS's power cord is not plugged in to the main power (constant), to prevent an electric shock.
- Be careful not to touch the surface of this unit's printed circuit board and be sure to wear cotton gloves.

1. Disconnect the GP2000/PS Series power cord from the power supply.
2. Remove the three (3) Expansion Slot covers on the rear of the GP2000/PS Series unit.

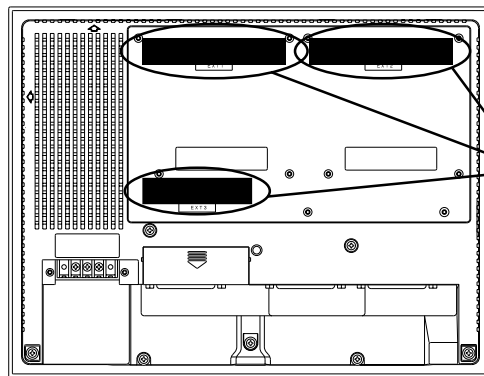

Expansion Slot covers

CAUTIONS

- Do not touch the "copper spring" or the copper spring's contact. Be sure to wear gloves when installing this unit.

Rear of Bus Conversion Unit

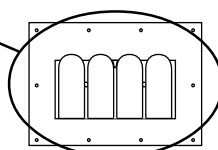
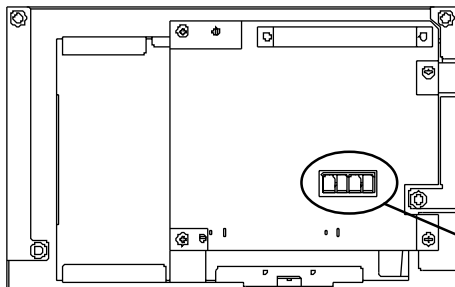

Copper Spring

Rear of GP

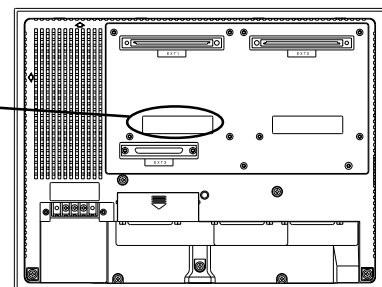

Copper spring contact location

- Do not remove this Unit from the GP2000/PS unless absolutely necessary. Excessive attachment and removal can lead to the Unit's premature breakdown or malfunction.

- Align the Expansion Bus Connector over the GP2000/PS Series unit's Rear Face Expansion Unit I/F. Then, press the Unit down so that the two unit's connect.

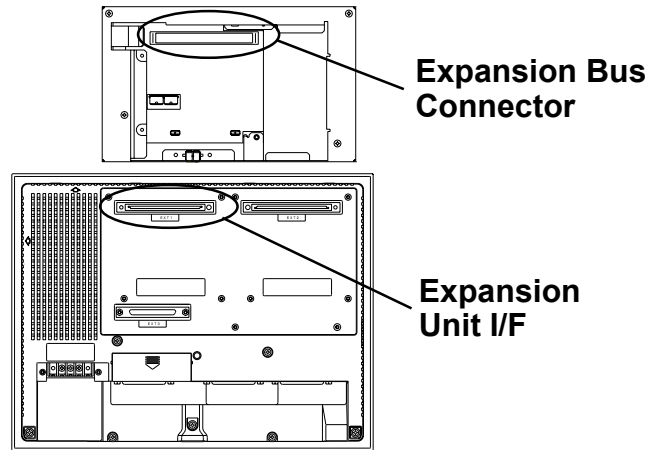

- After the two connectors are securely attached, insert the four (4) attachment screws into the four (4) attachment screw holes and tighten the screws. Be sure that no gaps remain between the GP2000/PS Series unit and the Unit.



A torque of only 0.5 to 0.6 N•m is required to tighten an attachment screw. Be careful not to use too much force, since it may damage the GP2000/PS unit.

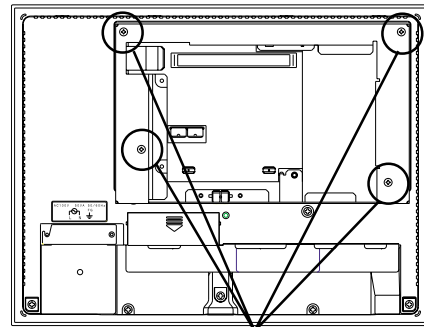

Attachment Screw Holes

- Insert the expansion unit Attachment Tabs into the GP2000/PS unit Attachment Slots. Be sure to install the expansion unit so that its smooth metal surface faces outward.

Attachment Tabs

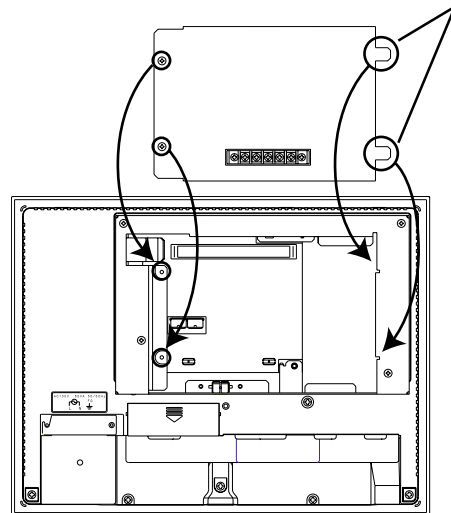

Reference Expansion Unit Users Manual

- Attach the expansion unit to the Bus Conversion unit and tighten the two (2) expansion unit attachment screws (included with unit).

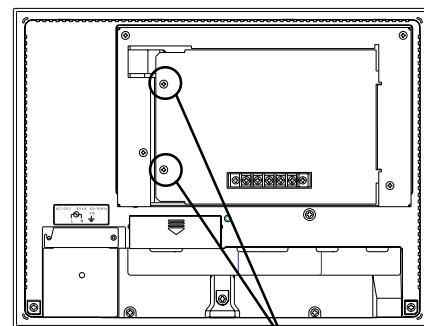

Attachment Screws