

MITSUBISHI

GT15

General Description

GT1595-XTBA GT1575V-STBA GT1575-VNBA
GT1595-XTBD GT1575V-STBD GT1575-VNBD
GT1585V-STBA GT1575-STBA GT1572-VNBA
GT1585V-STBD GT1575-STBD GT1572-VNBD
GT1585-STBA GT1575-VTBA GT1562-VNBA
GT1585-STBD GT1575-VTBD GT1562-VNBD
GT1565-VTBA GT1555-VTBD
GT1565-VTBD GT1555-QTBD
GT1555-QSBD
GT1550-QLBD

Thank you for purchasing the GOT1000 Series.

Prior to use, please read both this manual and detailed manual thoroughly to fully understand the product.

MODEL	GT15-U(HW)
MODEL CODE	1D7M38
IB(NA)-0800322-P(0811)MEE	

GRAPHIC OPERATION TERMINAL

GOT1000

● SAFETY PRECAUTIONS ●

(Always read these precautions before using this equipment.)

Before using this product, please read this manual and the relevant manuals introduced in this manual carefully and pay full attention to safety to handle the product correctly.

The precautions given in this manual are concerned with this product.

In this manual, the safety precautions are ranked as "DANGER" and "CAUTION".



DANGER

Indicates that incorrect handling may cause hazardous conditions, resulting in death or severe injury.



CAUTION

Indicates that incorrect handling may cause hazardous conditions, resulting in medium or slight personal injury or physical damage.

Note that the  caution level may lead to a serious accident according to the circumstances.

Always follow the instructions of both levels because they are important to personal safety.

Please save this manual to make it accessible when required and always forward it to the end user.

[DESIGN PRECAUTIONS]

DANGER

- Some failures of the GOT, communication unit or cable may keep the outputs on or off.
An external monitoring circuit should be provided to check for output signals which may lead to a serious accident.
Not doing so can cause an accident due to false output or malfunction.
- If a communication fault (including cable disconnection) occurs during monitoring on the GOT, communication between the GOT and PLC CPU is suspended and the GOT becomes inoperative.
For bus connection : The CPU becomes faulty and the GOT becomes inoperative.
For other than bus connection : The GOT becomes inoperative.
A system where the GOT is used should be configured to perform any significant operation to the system by using the switches of a device other than the GOT on the assumption that a GOT communication fault will occur.
Not doing so can cause an accident due to false output or malfunction.
- Do not use the GOT as the warning device that may cause a serious accident.
An independent and redundant hardware or mechanical interlock is required to configure the device that displays and outputs serious warning.
Failure to observe this instruction may result in an accident due to incorrect output or malfunction.
- Incorrect operation of the touch switch(s) may lead to a serious accident if the GOT backlight is gone out.
When the GOT backlight goes out, the POWER LED flickers (green/orange) and the display section turns black and causes the monitor screen to appear blank, while the input of the touch switch(s) remains active.
This may confuse an operator in thinking that the GOT is in "screensaver" mode, who then tries to release the GOT from this mode by touching the display section, which may cause a touch switch to operate.
Note that the following occurs on the GOT when the backlight goes out.
 - The POWER LED flickers (green/orange) and the monitor screen appears blank

[DESIGN PRECAUTIONS]

DANGER

- The display section of the GT1595-X is an analog-resistive type touch panel. If you touch the display section simultaneously in 2 points or more, the switch that is located around the center of the touched point, if any, may operate. Do not touch the display section in 2 points or more simultaneously. Doing so may cause an accident due to incorrect output or malfunction.
- When programs or parameters of the controller (such as a PLC) that is monitored by the GOT are changed, be sure to reset the GOT or shut off the power of the GOT at the same time. Not doing so can cause an accident due to false output or malfunction.

CAUTION

- Do not bundle the control and communication cables with main-circuit, power or other wiring. Run the above cables separately from such wiring and keep them a minimum of 100mm apart. Not doing so noise can cause a malfunction.
- Do not press the GOT display section with a pointed material as a pen or driver. Doing so can result in a damage or failure of the display section.

[MOUNTING PRECAUTIONS]

DANGER

- Be sure to shut off all phases of the external power supply used by the system before mounting or removing the GOT main unit to/from the panel. Not doing so can cause the unit to fail or malfunction.
- Be sure to shut off all phases of the external power supply used by the system before mounting or removing the communication unit, option function board or multi-color display board onto/from the GOT. Not doing so can cause the unit to fail or malfunction.

[MOUNTING PRECAUTIONS]

DANGER

- When installing the multi-color display board, wear an earth band etc. to avoid the static electricity.
Not doing so can cause a unit corruption.

CAUTION

- Use the GOT in the environment that satisfies the general specifications described in this manual.
Not doing so can cause an electric shock, fire, malfunction or product damage or deterioration.
- When mounting the GOT to the control panel, tighten the mounting screws in the specified torque range.
Undertightening can cause the GOT to drop, short circuit or malfunction.
Overtightening can cause a drop, short circuit or malfunction due to the damage of the screws or the GOT.
- When loading the communication unit to the GOT, fit it to the connection interface of the GOT and tighten the mounting screws in the specified torque range.
Under tightening can cause the GOT to drop, short circuit or malfunction.
Overtightening can cause a drop, failure or malfunction due to the damage of the screws or unit.
- When mounting the multi-color display board onto the GOT, tighten the mounting screws within the specified torque range.
Loose tightening may cause the unit and/or GOT to malfunction due to poor contact.
Overtightening may damage the screws, unit and/or GOT; they might malfunction.
- Push the option function board onto the corresponding connector until it clicks, so that it will be secured firmly.
- Push the multi-color display board onto the corresponding connector so that it will be secured firmly.
- When inserting a CF card into the GOT, push it into the insertion slot until the CF card eject button will pop out.
Failure to do so may cause a malfunction due to poor contact.

[MOUNTING PRECAUTIONS]

CAUTION

- When inserting/removing a CF card into/from the GOT, turn the CF card access switch off in advance.
Failure to do so may corrupt data within the CF card
- When removing a CF card from the GOT, make sure to support the CF card by hand, as it may pop out.
Failure to do so may cause the CF card to drop from the GOT and break.
- Operate and store the GOT in environments without direct sunlight, high temperature, dust, humidity, and vibrations.

[WIRING PRECAUTIONS]

DANGER

- Be sure to shut off all phases of the external power supply used by the system before wiring.
Failure to do so may result in an electric shock, product damage or malfunctions.

CAUTION

- Always ground the FG terminal, LG terminal, and protective ground terminal of the GOT power to the protective ground conductors dedicated to the GOT.
- Not doing so may cause an electric shock or malfunction. Terminal screws which are not to be used must be tightened always at torque 0.5 to 0.8 N•m. Otherwise there will be a danger of short circuit against the solderless terminals.
- Use applicable solderless terminals and tighten them with the specified torque.
If any solderless spade terminal is used, it may be disconnected when the terminal screw comes loose, resulting in failure.
- Correctly wire the GOT power supply section after confirming the rated voltage and terminal arrangement of the product.
Not doing so can cause a fire or failure.

[WIRING PRECAUTIONS]

CAUTION

- Tighten the terminal screws of the GOT power supply section in the specified torque range. Undertightening can cause a short circuit or malfunction. Overtightening can cause a short circuit or malfunction due to the damage of the screws or the GOT.
- Exercise care to avoid foreign matter such as chips and wire offcuts entering the GOT. Not doing so can cause a fire, failure or malfunction.
- The module has an ingress prevention label on its top to prevent foreign matter, such as wire offcuts, from entering the module during wiring. Do not peel this label during wiring. Before starting system operation, be sure to peel this label because of heat dissipation.
- Plug the communication cable into the connector of the connected unit and tighten the mounting and terminal screws in the specified torque range. Undertightening can cause a short circuit or malfunction. Overtightening can cause a short circuit or malfunction due to the damage of the screws or unit.
- Plug the QnA/ACPU/Motion controller(A series) bus connection cable by inserting it into the connector of the connected unit until it "clicks". After plugging, check that it has been inserted snugly. Not doing so can cause a malfunction due to a contact fault.

[TEST OPERATION PRECAUTIONS]

DANGER

- Before performing the test operations of the user creation monitor screen (such as turning ON or OFF bit device, changing the word device current value, changing the settings or current values of the timer or counter, and changing the buffer memory current value), read through the manual carefully and make yourself familiar with the operation method. During test operation, never change the data of the devices which are used to perform significant operation for the system. False output or malfunction can cause an accident.

[STARTUP/MAINTENANCE PRECAUTIONS]

DANGER

- When power is on, do not touch the terminals.
Doing so can cause an electric shock or malfunction.
- Correctly connect the battery connector.
Do not charge, disassemble, heat, short-circuit, solder, or throw the battery into the fire.
Doing so will cause the battery to produce heat, explode, or ignite, resulting in injury and fire.
- Before starting cleaning or terminal screw retightening, always switch off the power externally in all phases.
Not switching the power off in all phases can cause a unit failure or malfunction.
Undertightening can cause a short circuit or malfunction.
Overtightening can cause a short circuit or malfunction due to the damage of the screws or unit.

CAUTION

- Do not disassemble or modify the unit.
Doing so can cause a failure, malfunction, injury or fire.
- Do not touch the conductive and electronic parts of the unit directly.
Doing so can cause a unit malfunction or failure.
- The cables connected to the unit must be run in ducts or clamped.
Not doing so can cause the unit or cable to be damaged due to the dangling, motion or accidental pulling of the cables or can cause a malfunction due to a cable connection fault.
- When unplugging the cable connected to the unit, do not hold and pull the cable portion.
Doing so can cause the unit or cable to be damaged or can cause a malfunction due to a cable connection fault.
- Do not drop the module or subject it to strong shock. A module damage may result.

[STARTUP/MAINTENANCE PRECAUTIONS]

CAUTION

- Do not drop or give an impact to the battery mounted to the unit.
Doing so may damage the battery, causing the battery fluid to leak inside the battery.
If the battery is dropped or given an impact, dispose of it without using.
- Before touching the unit, always touch grounded metals, etc. to discharge static electricity from human body, etc.
Not doing so can cause the unit to fail or malfunction.

[BACKLIGHT CHANGING PRECAUTIONS]

DANGER

- Before changing the backlight, always switch off the GOT power externally in all phases (when the GOT is connected to the bus, the PLC CPU power must also be switched off externally in all phases) and remove the GOT from the control panel.
Not switching the power off in all phases may cause an electric shock.
Not removing the unit from the control panel can cause injury due to a drop.

CAUTION

- When replacing the backlight, use the gloves.
Otherwise, it may cause you to be injured.
- Start changing the backlight more than 5 minutes after switching the GOT power off.
Not doing so can cause a burn due to the heat of the backlight.

[DISPOSAL PRECAUTIONS]

CAUTION

- When disposing of the product, handle it as industrial waste.
When disposing of the battery, dispose of it separately based on the law in each region.
(Refer to GT15 User's Manual for details of the battery regulations in the EU member countries.)

[TRANSPORTATION PRECAUTIONS]

CAUTION

- When transporting lithium batteries, make sure to treat them based on the transport regulations.
(Refer to GT15 User's Manual for details of the regulated models.)
- Make sure to transport the GOT main unit and/or relevant unit(s) in the manner they will not be exposed to the impact exceeding the impact resistance described in the general specifications of the GT15 User's Manual, as they are precision devices.
Failure to do so may cause the unit to fail.
Check if the unit operates correctly after transportation.

REVISIONS

* The manual number is noted at the lower right of the top cover.

Print Date	*Manual Number	Revision
Apr., 2005	IB(NA)-0800322-A	First edition
Jul., 2005	IB(NA)-0800322-B	<p>Partial corrections Section 2.1, 2.2, 2.3, 3.2, 5.5, 6.1, 6.5, 7.3.4</p> <p>Partial additions SAFETY PRECAUTIONS, Section 4.3.2, 4.4.2, 5.3, 7.3.2, 7.3.3</p>
Oct., 2005	IB(NA)-0800322-C	<p>Partial corrections Chapter 1, Section 2.1 to 2.3 → 2.2 to 2.4, Section 3.2, 3.3, 3.4, 4.4.1, 5.2, 5.3, 5.5, 7.3.3</p> <p>Partial additions Product Components, Section 3.4, 4.3.2, 4.3.3, 4.4.1, 7.2</p> <p>Additions Section 2.1, 3.2.1 to 3.2.4, 3.3.1, 3.3.2</p>
Dec., 2005	IB(NA)-0800322-D	<p>Partial corrections Section 4.3.3, 4.4.2</p>
Mar., 2006	IB(NA)-0800322-E	<p>Partial corrections Chapter 1, Section 2.1, 2.2, 2.3, 2.4</p> <p>Partial additions Product Components, Section 3.2, 3.2.1, 3.2.2, 3.2.3, 3.2.4, 3.3, 3.4, 4.3.1, 4.3.2, 4.3.3, 5.2, 5.3, 6.2, 7.3.3</p> <p>Additions Section 2.5, 3.2.5, 5.3.4</p>
May, 2006	IB(NA)-0800322-F	<p>Partial corrections SAFETY PRECAUTIONS, Section 2.3, 2.5</p> <p>Partial additions Section 3.2.2, 3.2.3, 3.3.2</p>

Print Date	*Manual Number	Revision
Aug., 2006	IB(NA)-0800322-G	Partial corrections Chapter 6 Partial additions Section 4.3.1, 4.3.3, 4.3.4, 5.3
Sep., 2006	IB(NA)-0800322-H	Partial corrections Chapter 4
Oct., 2006	IB(NA)-0800322-I	Partial corrections Section 3.2.1, 3.2.2, 3.2.3, 3.2.4, 3.2.5, 3.3.1
Nov., 2006	IB(NA)-0800322-J	Partial corrections Section 5.5, 6.4.1, 6.4.2
Feb., 2007	IB(NA)-0800322-K	Partial corrections Product Components, Section 3.2, 3.2.1, 3.2.2, 3.2.3, 3.2.4, 3.2.5, 3.3.2, 5.2, 5.3, 6.3, 6.4, 6.4.2, 6.5.1, 6.7.2
Jul., 2007	IB(NA)-0800322-L	Partial corrections Section 3.2.2
Oct., 2007	IB(NA)-0800322-M	Partial corrections Section 3.2.1 Partial additions Section 3.2.1, 3.2.2, 3.2.3, 3.2.4, 3.2.5
Jan., 2008	IB(NA)-0800322-N	Partial additions SAFETY PRECAUTIONS, Section 3.2, 5.3
Feb., 2008	IB(NA)-0800322-O	Partial corrections Section 5.3
Nov., 2008	IB(NA)-0800322-P	Partial corrections Section 7.3.4 Partial additions SAFETY PRECAUTIONS, Section 3.1, 3.2.1, 3.2.2, 3.2.3, 3.2.4, 3.2.5, 7.3.2

This manual confers no industrial property rights or any rights of any other kind, nor does it confer any patent licenses. Mitsubishi Electric Corporation cannot be held responsible for any problems involving industrial property rights which may occur as a result of using the contents noted in this manual.

CONTENTS

1. Features	1
2. Part Names	3
2.1 Part Names and Settings of the GT1595	3
2.2 Part Names and Settings of the GT1585	4
2.3 Part Names and Settings of the GT157	5
2.4 Part Names and Settings of the GT156	6
2.5 Part Names and Settings of the GT155	7
3. Specifications	8
3.1 General Specifications	8
3.2 Performance Specifications	10
3.2.1 GT1595-X	10
3.2.2 GT1585V-S, GT1585-S	13
3.2.3 GT1575V-S, GT1575-S, GT1575-V, GT1575-VN, GT1572-VN ...	16
3.2.4 GT1565-V, GT1562-VN	20
3.2.5 GT1555-V, GT1555-Q, GT1550-Q	23
3.3 Power Supply Specifications	26
3.3.1 For GOTs powered from the 100 to 240VAC power supply	27
3.3.2 For GOTs powered from the 24VDC power supply	28
3.4 External Dimensions	30
4. EMC and Low Voltage Directive	33
5. Installation	34
5.1 Control Panel Inside Dimensions for Mounting GOT	34
5.2 Panel Cutting Dimensions	34
5.3 Mounting Position	35
5.4 Control Panel Inside Temperature and Mounting Angle	38
5.5 Installation Procedure	39
6. Wiring	40
6.1 Wiring Precautions	40
6.2 Power Supply Wiring	42
6.3 Wiring to GOT Power Section	43
6.4 Grounding	44
6.4.1 Grounding the GOT	44
6.4.2 Wiring-related malfunction causes and the measures examples	48
6.5 Panel Inside Wiring, Panel Outside Wiring	50
6.5.1 Panel inside wiring	50

6.5.2 Panel outside wiring	51
6.6 Attaching Surge Suppressor for Control Equipment	52
6.7 Wiring FG Cable of Bus Connection Cable	53
6.7.1 When connecting QCPU or motion controller CPU (Q series) to the GOT	53
6.7.2 When connecting QnACPU, ACPU, or motion controller CPU (A series) to the GOT	53
7. Maintenance and Inspection	55
7.1 Daily Inspection	55
7.2 Periodic Inspection	56
7.3 Battery Voltage Low Detection and Battery Replacement	57
7.3.1 Applicable battery	57
7.3.2 Battery specifications	57
7.3.3 Battery replacement procedure	58
7.3.4 Battery life	59
Appendix. Confirming of Versions and Conformed Standards	60

Manuals

The following shows manuals relevant to this product.

Detailed Manual

Manual name	Manual Number (Model code)
GT15 User's Manual (Sold separately)	SH-080528ENG (1D7M23)

Relevant Manual

For relevant manuals, refer to the PDF manual stored within the drawing software used.

Packing List

The GOT product package includes the following:

Model name	Product	Quantity
GT1595-X	GOT	1
	Installation fitting	8
GT1585V-S, GT1585-S, GT1575V-S, GT1575-S, GT1575-V, GT1575-VN, GT1572-VN, GT1565-V, GT1562-VN, GT1555-V, GT1555-Q, GT1550-Q	GOT	1
	Installation fitting	4

1.Features

- (1) Improved monitoring performance and connectivity to FA devices
 - Using of TFT color liquid crystal display (high intensity, wide angle view and high definition type) provides clear full-color display and displays small characters clearly. (Displays digital images of BMP and other formats in 65536 colors.)^{*1}
 - Provides multi-language display function based on Unicode2.1 True Type font and high-speed drawing of beautiful text.
 - High speed monitoring through high speed communication at maximum of 115.2kbps.
 - High speed display and high speed touch switch response.
- (2) More efficient GOT operations including screen design, startup, adjustment, management and maintenance works
 - 9MB user memory is included as standard. (Memory capacity can be expanded up to 57MB by increasing the option memory)^{*1}
 - CF card interface is included as standard.
 - Font installation is available to increase the system fonts.
 - Combined use of 4 types of alarms (system alarm, user alarm, alarm history, alarm popup display) realizes more efficient alarm notification.
 - Maintenance timing report function is available that measures the backlight energization time and notifies of maintenance time.
 - The USB connector is positioned on the GOT front. This enables the system startup to be performed more efficiently using FA device startup tool, and eliminates the necessity of indirect works (opening and closing the control panel, cable replacement, cable rewiring) in order to improve the working efficiency.
 - The blown backlight bulb can be confirmed even during screen saving, with the blinked POWER LED at backlight shutoff detection.

(3) Enhanced support of FA device setup tools

- Transferring and monitoring sequence programs with the personal computer connected to the GOT can be executed when connecting to a PLC CPU with the direct CPU connection or bus connection. (FA transparent function)

*1 The specifications differ depending on the GOT to be used.
For the specifications, refer to the following.



3.2 Performance Specifications

2.Part Names

2.1 Part Names and Settings of the GT1595

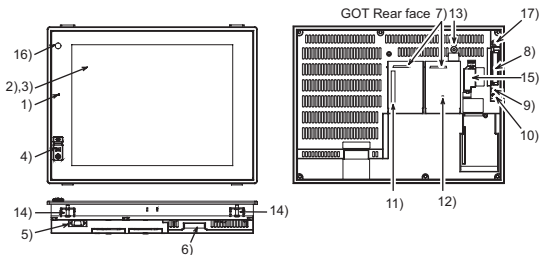

No.	Name	Description
1)	POWER LED	Lit in green:Power is correctly supplied Lit in orange:Screen saving Blinks in orange/green:Blown back light bulb Not lit :Power is not supplied
2)	Display screen	Displays the Utility and the user creation screen.
3)	Touch key	For operating touch switches in the Utility and the user creation screen
4)	USB interface	For connecting a personal computer (Connector type: MINI-B)
5)	RS-232 interface	For communicating with a controller or connecting a personal computer (Connector type: D sub 9-pin)
6)	Power terminal	Power input terminal, LG terminal, FG terminal
7)	Extension interface	For installing an extension unit
8)	CF card interface	For installing a CF card
9)	CF card access LED	Lit :CF card accessed Not lit:CF card not accessed
10)	CF card access switch	Used for stopping the access to the CF card before removing the CF card from the GOT ON :CF card being accessed (CF card removal prohibited) OFF :CF card not accessed (CF card removal possible)
11)	Optional function board interface	For installing the optional function board
12)	Multi-color display board interface*1	For installing the multi-color display board
13)	Reset switch	Hardware reset switch (Inoperative in the bus connection or with the bus connection unit installed)
14)	Hole for unit installation fitting	Hole for inserting the unit installation fitting
15)	Battery holder	Houses the battery
16)	Human sensor	Sensor that detects human movement
17)	Installation switch	Used for OS installations at the GOT startup

*1 For the multi-color display board, refer to the following.

 3.2.1 GT1595-X

2.2 Part Names and Settings of the GT1585

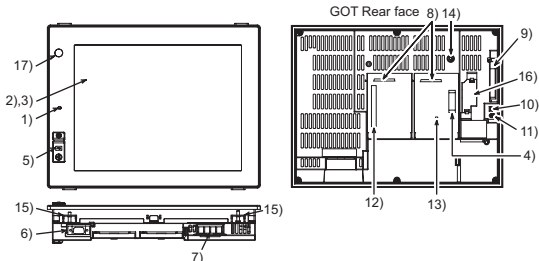

No.	Name	Description
1)	POWER LED	Lit in green:Power is correctly supplied Lit in orange:Screen saving Blinks in orange/green:Blown back light bulb Not lit :Power is not supplied
2)	Display screen	Displays the Utility and the user creation screen
3)	Touch key	For operating touch switches in the Utility and the user creation screen
4)	Video/RGB interface*1	For installing the video input unit, RGB input unit, video/RGB input unit, or RGB output unit
5)	USB interface	For connecting a personal computer (Connector type: MINI-B)
6)	RS-232 interface	For communicating with a controller or connecting a personal computer (Connector type: D sub 9-pin)
7)	Power terminal	Power input terminal, LG terminal, FG terminal
8)	Extension interface	For installing an extension unit
9)	CF card interface	For installing a CF card
10)	CF card access LED	Lit :CF card accessed Not lit:CF card not accessed
11)	CF card access switch	Used for stopping the access to the CF card before removing the CF card from the GOT ON :CF card being accessed (CF card removal prohibited) OFF :CF card not accessed (CF card removal possible)
12)	Optional function board interface	For installing the optional function board
13)	Multi-color display board interface*2	For installing the multi-color display board
14)	Reset switch	Hardware reset switch (Inoperative in the bus connection or with the bus connection unit installed)
15)	Hole for unit installation fitting	Hole for inserting the unit installation fitting
16)	Battery holder	Houses the battery
17)	Human sensor	Sensor that detects human movement

*1 It is provided for the GT1585V-S only.

*2 For the multi-color display board, refer to the following.



3.2.2 GT1585V-S, GT1585-S

2.3 Part Names and Settings of the GT157□

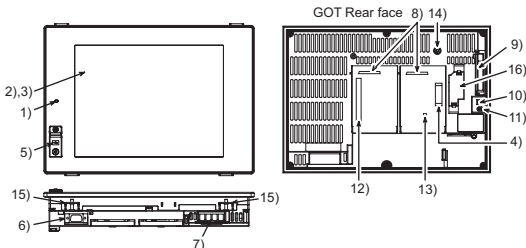

No.	Name	Description
1)	POWER LED	Lit in green:Power is correctly supplied Lit in orange:Screen saving Blinks in orange/green:Blown back light bulb Not lit :Power is not supplied
2)	Display screen	Displays the Utility and the user creation screen
3)	Touch key	For operating touch switches in the Utility and the user creation screen
4)	Video/RGB interface *1	For installing the video input unit, RGB input unit, video/RGB input unit, or RGB output unit
5)	USB interface	For connecting a personal computer (Connector type: MINI-B)
6)	RS-232 interface	For communicating with a controller or connecting a personal computer (Connector type: D sub 9-pin)
7)	Power terminal	Power input terminal, LG terminal, FG terminal
8)	Extension interface	For installing an extension unit
9)	CF card interface	For installing a CF card
10)	CF card access LED	Lit :CF card accessed Not lit:CF card not accessed
11)	CF card access switch	Used for stopping the access to the CF card before removing the CF card from the GOT ON :CF card being accessed (CF card removal prohibited) OFF :CF card not accessed (CF card removal possible)
12)	Optional function board interface	For installing the optional function board
13)	Multi-color display board interface *2	For installing the multi-color display board (For GT1575-VN and GT1572-VN, 65536 color display is not supported even with the multi-color display board installed.)
14)	Reset switch	Hardware reset switch (Inoperative in the bus connection or with the bus connection unit installed)
15)	Hole for unit installation fitting	Hole for inserting the unit installation fitting
16)	Battery holder	Houses the battery

*1 It is provided for the GT1575V-S only.

*2 For the multi-color display board, refer to the following.



3.2.3 GT1575V-S, GT1575-S, GT1575-V, GT1575-VN,
GT1572-VN

2.4 Part Names and Settings of the GT156□

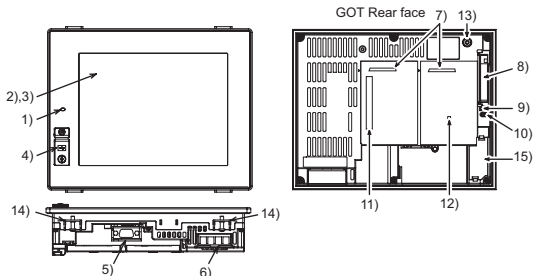

No.	Name	Description
1)	POWER LED	Lit in green:Power is correctly supplied Lit in orange:Screen saving Blinks in orange/green:Blown back light bulb Not lit :Power is not supplied
2)	Display screen	Displays the Utility and the user creation screen
3)	Touch key	For operating touch switches in the Utility and the user creation screen
4)	USB interface	For connecting a personal computer (Connector type: MINI-B)
5)	RS-232 interface	For communicating with a controller or connecting a personal computer (Connector type: D sub 9-pin)
6)	Power terminal	Power input terminal, LG terminal, FG terminal
7)	Extension interface	For installing an extension unit
8)	CF card interface	For installing a CF card
9)	CF card access LED	Lit :CF card accessed Not lit:CF card not accessed
10)	CF card access switch	Used for stopping the access to the CF card before removing the CF card from the GOT ON :CF card being accessed (CF card removal prohibited) OFF :CF card not accessed (CF card removal possible)
11)	Optional function board interface	For installing the optional function board
12)	Multi-color display board interface ^{*1}	For installing the multi-color display board (For GT1562-VN, 65536 color display is not supported even with the multi-color display board installed.)
13)	Reset switch	Hardware reset switch (Inoperative in the bus connection or with the bus connection unit installed)
14)	Hole for unit installation fitting	Hole for inserting the unit installation fitting
15)	Battery holder	Houses the battery

*1 For the multi-color display board, refer to the following.



3.2.4 GT1565-V, GT1562-VN

2.5 Part Names and Settings of the GT155□

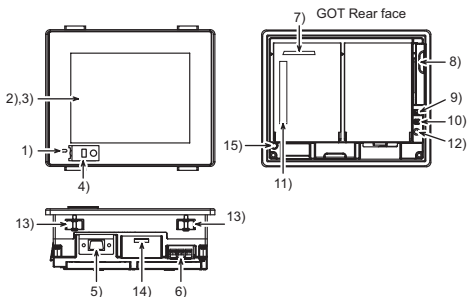

No.	Name	Description
1)	POWER LED	Lit in green:Power is correctly supplied Lit in red:Screen saving Blinks in red:Blown back light bulb Not lit :Power is not supplied
2)	Display screen	Displays the Utility and the user creation screen
3)	Touch key	For operating touch switches in the Utility and the user creation screen
4)	USB interface	For connecting a personal computer (Connector type: MINI-B)
5)	RS-232 interface	For communicating with a controller or connecting a personal computer (Connector type: D sub 9-pin)
6)	Power terminal	Power input terminal, FG terminal
7)	Extension interface	For installing an extension unit
8)	CF card interface	For installing a CF card
9)	CF card access LED	Lit :CF card accessed Not lit:CF card not accessed
10)	CF card access switch	Used for stopping the access to the CF card before removing the CF card from the GOT ON :CF card being accessed (CF card removal prohibited) OFF :CF card not accessed (CF card removal possible)
11)	Optional function board interface	For installing the optional function board
12)	Reset switch	Hardware reset switch (Inoperative in the bus connection or with the bus connection unit installed)
13)	Hole for unit installation fitting	Hole for inserting the unit installation fitting
14)	Battery holder	Houses the battery
15)	Protective ground terminal	For earthing

3. Specifications

3.1 General Specifications

Item		Specifications					
Operating ambient temperature*1	Display section	0 to 50°C					
	Other than the display section	0 to 55°C					
Storage ambient temperature		-20 to 60°C					
Operating ambient humidity*6		10 to 90% RH, non-condensing					
Storage ambient humidity*6		10 to 90% RH, non-condensing					
Vibration resistance*2	Compliant with JIS B3502 and IEC61131-2	Under intermittent vibration	Frequency	Acceleration	Half-amplitude	Sweep count	10 times each in X, Y and Z directions
			5 to 9Hz	-	3.5mm		
		9 to 150Hz	9.8m/s ²	-			
		Under continuous vibration	5 to 9Hz	-	1.75mm		
			9 to 150Hz	4.9m/s ²	-		
Shock resistance		Compliant with JIS B3502 and IEC61131-2 (147 m/s ² , 3 times each in X, Y and Z directions)					
Operating atmosphere		No corrosive gas					
Operating altitude*3		2000 m (6562 ft) max.					
Installation location		Inside control panel					
Overvoltage category*4		II or less					
Pollution degree*5		2 or less					
Cooling method		Self-cooling					
Grounding		Grounding with a resistance of 100 Ω or less					

- *1 When mounting MELSECNET/H communication unit (GT15-J71LP23-25, GT15-J71BR13) or CC-Link communication unit (GT15-J61BT13), the operating ambient temperature must be reduced 5°C against the maximum values described in general specifications.
When using the GOT with a fingerprint unit (GT15-80FPA) mounted, the operating ambient temperature must be in the range of 0 to 40°C.
- *2 When using the MELSECNET/10 communication unit (GT15-75J71LP23-Z, GT15-75J71BR13-Z) or CC-Link communication unit (GT15-75J61BT13-Z), refer to the manual of the communication unit you use. (Differs with the specification of GOT.)
- *3 Do not use or store the GOT under pressure higher than the atmospheric pressure of altitude 0m (0ft.). Failure to observe this instruction may cause a malfunction.
When an air purge is made inside the control panel by adding pressure, there may be a clearance between the surface sheet and the screen making it difficult to use the touch panel, or the sheet may come off.
- *4 This indicates the section of the power supply to which the equipment is assumed to be connected between the public electrical power distribution network and the machinery within the premises. Category II applies to equipment for which electrical power is supplied from fixed facilities.
The surge voltage withstand level for up to the rated voltage of 300 V is 2500 V.
- *5 This index indicates the degree to which conductive material is generated in the environment where the equipment is used. In pollution degree 2, only non-conductive pollution occurs but temporary conductivity may be produced due to condensation.
- *6 The wet-bulb temperature is 39°C or less for STN LCDs.
When using the GOT with a fingerprint unit (GT15-80FPA) mounted, the operating ambient humidity must be in the range of 10 to 85%RH and there must be no condensation.

3.2 Performance Specifications

The performance specifications of the GT15 is as follows.



- 3.2.1 GT1595-X
- 3.2.2 GT1585V-S, GT1585-S
- 3.2.3 GT1575V-S, GT1575-S, GT1575-V, GT1575-VN, GT1572-VN
- 3.2.4 GT1565-V, GT1562-VN
- 3.2.5 GT1555-V, GT1555-Q, GT1550-Q

3.2.1 GT1595-X

Item		Specifications	
		GT1595-XTBA	GT1595-XTBD
Display section *1	Type	TFT color liquid crystal display (High intensity and wide angle view)	
	Screen size	15"	
	Resolution	1,024 × 768 dots	
	Display size	304.1(12.0)(W) × 228.1(8.98)(H) [mm](inch)	
	Display character	16-dot standard font : 64 characters × 48 lines (2byte character)	
		12-dot standard font : 85 characters × 64 lines (2byte character)	
	Display color	65536 colors *2	
	Display angle	Left/Right: 75 degrees Top : 50 degrees Bottom : 60 degrees	
	Intensity of LCD only	450 [cd/m ²]	
	Intensity adjustment	8-level adjustment	
Life	Approx. 52,000 h (Operating ambient temperature : 25°C)		
Backlight		Cold cathode fluorescent tube (replaceable) backlight shutoff detection function is included Backlight off/screen saving time can be set.	
	Life*3	Approx. 50,000 h or longer (Time when display luminance reaches 50% at the operating ambient temperature of 25°C)	
Touch panel	Type	Analog resistive film	
	Key size	Minimum 2 × 2 dots (per key)	
	Number of objects that can be simultaneously touched	Simultaneous presses not allowed. (Only 1 point can be touched.)	
	Life	1 million times or more (operating force 0.98N max.)	

(Continued to next page)

Item		Specifications	
		GT1595-XTBA	GT1595-XTBD
Human sensor	Detection length	1(39.37) [m](inch)	
	Detection range	Left/Right/Top/Bottom: 70 degrees	
	Detection delay time	0 to 4s	
	Detection temperature	Temperature difference between human body and ambient air: 4°C or higher	
Memory ^{*4}	C drive	Built-in flash memory 9Mbytes (for storing project data and OS)	
	Life (Number of write times)	100,000 times	
Battery		GT15-BAT lithium battery (Option)	
	Backup target	Clock data and maintenance time notification data	
	Life	Approx. 5 years (Operating ambient temperature of 25°C)	
Built-in interface	RS-232 ^{*6}	RS-232, 1ch Transmission speed : 115,200/57,600/38,400/19,200/9,600/4,800 bps Connector shape : D-sub 9-pin (Male) Application : For communicating with a controller or connecting a personal computer (Project data upload/download, OS installation, FA transparent function)	
	USB	USB (Full Speed 12Mbps), Device, 1ch Connector shape: TYPE Mini-B Application: For connecting a personal computer (Project data upload/download, OS installation and FA transparent function))	
	CF card	Compact flash slot, 1ch Connector shape : TYPE I Application : Data transfer, data storage, GOT startup	
	Option function board	For option function board mounting, 1ch	
	Multi-color display board	For multi-color display board mounting, 1ch	
	Extension unit ^{*6}	For communication unit/option unit mounting, 2ch	
Buzzer output		Single tone (tone length adjustable)	
Protective structure		Outside the enclosure: IP67 ^{*5} Inside the enclosure: IP2X	
External dimensions (Excluding USB environmental protection cover)		397(15.6)(W) × 296(11.7)(H) × 61(2.40)(D)[mm](inch)	
Panel cutting dimensions		383.5(15.1)(W) × 282.5(11.1)(H)[mm](inch)	
Weight		5.0kg(11.0lb) (mounting fixtures are not included)	
Compatible software package (GT Designer2 Version)		2.17T or later	2.30G or later

- *1 Bright dots (always lit) and dark dots (unlit) may appear on a liquid crystal display panel due to its characteristics. It is impossible to completely avoid this symptom, as the liquid crystal display comprises of a great number of display elements. Please note that these dots appear due to its characteristic and are not caused by product defect.
- *2 With the hardware version indicated below, it will be 256 colors when the multi-color display board is not installed.
For how to confirm the function version, refer to the following.



Appendix Confirming of Versions and Conformed Standards

Item	Model	Function version
GT1595	GT1595-XTBA	A

- *3 The GOT screen saving/backlight off function prevents images from becoming permanently etched on the display screen and increases the backlight life.
- *4 ROM in which new data can be written without deleting the written data.
- *5 Compliant with IP67 when the USB environmental protection cover is attached. Compliant with IP2X at the USB interface only when a USB cable is connected. Note that this does not guarantee all users' operation environment.
- *6 For using multiple extension units, a fingerprint unit, a bar code reader, or a RFID controller, the total current for the extension units, fingerprint unit, bar code reader, or RFID controller must be within the current that the GOT can supply.
For the current for the extension units, fingerprint unit, bar code reader or RFID controller, and the current that the GOT can supply, refer to the following manual.



GT Designer2 Version □ Screen Design Manual

3.2.2 GT1585V-S, GT1585-S

Item		Specifications			
		GT1585V-STBA	GT1585V-STBD	GT1585-STBA	GT1585-STBD
Display section *1	Type	TFT color liquid crystal display (High intensity and wide angle view)			
	Screen size	12.1"			
	Resolution	800 × 600 dots			
	Display size	246(9.69)(W) × 184.5(7.26)(H) [mm](inch)			
	Display character	16-dot standard font : 50 characters × 37 lines (2byte characters) 12-dot standard font : 66 characters × 50 lines (2byte characters)			
	Display color	65536 colors *2			
	Display angle	Left/Right: 60 degrees Top : 40 degrees Bottom : 50 degrees		Left/Right: 65 degrees Top : 45 degrees Bottom : 55 degrees	
	Intensity of LCD only	350 [cd/m ²]		400 [cd/m ²]	
	Intensity adjustment	8-level adjustment			
	Life	Approx. 50,000 h (Operating ambient temperature : 25°C)			
Backlight	Cold cathode fluorescent tube (replaceable) backlight shut-off detection function is included. Backlight off/screen saving time can be set.				
	Life*3	Approx. 50,000 h or longer (Time when display luminance reaches 50% at the operating ambient temperature of 25°C)			
Touch panel	Type	Matrix resistive film			
	Number of touch keys	1,900 objects/screen (38 lines × 50 columns)			
	Key size	Minimum 16 × 16 dots (16 × 8 dots for the last line only) (per key)			
	Number of objects that can be simultaneously touched	Maximum of 2 objects			
	Life	1 million times or more (operating force 0.98N max.)			
Human Sensor	Detection length	1(39.37) [m](inch)			
	Detection range	Left/Right/Top/Bottom: 70 degrees			
	Detection delay time	0 to 4s			

(Continued to next page)

Item		Specifications			
		GT1585V-STBA	GT1585V-STBD	GT1585-STBA	GT1585-STBD
Human Sensor	Detection temperature	Temperature difference between human body and ambient air: 4°C or higher			
Memory *4	C drive	Built-in flash memory 9Mbytes (for storing project data and OS)			
	Life (Number of write times)	100,000 times			
Battery		GT15-BAT lithium battery (Option)			
	Backup target	Clock data and maintenance time notification data			
	Life	Approx. 5 years (Operating ambient temperature of 25°C)			
Built-in interface	RS-232*6	RS-232, 1ch Transmission speed:115,200/57,600/38,400/19,200/9,600/4,800 bps Connector shape:D-sub 9-pin (Male) Application:For communicating with a controller or connecting a personal computer (Project data upload/download, OS installation, FA transparent function)			
	USB	USB (Full Speed 12Mbps), Device, 1ch Connector shape:TYPE Mini-B Application:For connecting a Personal computer (Project data upload/download, OS installation and FA transparent function)			
	CF card	Compact flash slot, 1ch Connector shape:TYPE I Application:Data transfer, data storage, GOT startup			
	Option function board	For option function board mounting, 1ch			
	Multi-color display board	For multi-color display board mounting, 1ch			
	Extension unit*6	For communication unit/option unit mounting, 2ch			
	Buzzer output	Single tone (tone length adjustable)			
Protective structure	Outside the enclosure: IP67 *5 Inside the enclosure: IP2X				
External dimensions (Excluding USB environmental protection cover)	316(12.44)(W) × 242(9.53)(H) × 52(2.05)(D) [mm](inch)				
Panel cutting dimensions	302(11.89)(W) × 228(8.98)(H)[mm](inch)				
Weight	2.8 kg(6.2lb) (mounting fixtures are not included)				
Compatible software package (GT Designer2 Version)	2.30G or later		2.04E or later		2.17T or later

- *1 Bright dots (always lit) and dark dots (unlit) may appear on a liquid crystal display panel due to its characteristics. It is impossible to completely avoid this symptom, as the liquid crystal display comprises of a great number of display elements. Please note that these dots appear due to its characteristic and are not caused by product defect.
- *2 With the hardware version indicated below, it will be 256 colors when the multi-color display board is not installed.
For how to confirm the function version, refer to the following.



Appendix Confirming of Versions and Conformed Standards

Item	Model	Function version
GT1585	GT1585-STBA	A
	GT1585-STBD	A

- *3 The GOT screen saving/backlight off function prevents images from becoming permanently etched on the display screen and increases the backlight life.
- *4 ROM in which new data can be written without deleting the written data.
- *5 Compliant with IP67 when the USB environmental protection cover is attached. Compliant with IP2X at the USB interface only when a USB cable is connected. Note that this does not guarantee all users' operation environment.
- *6 For using multiple extension units, a fingerprint unit, a bar code reader, or a RFID controller, the total current for the extension units, fingerprint unit, bar code reader, or RFID controller must be within the current that the GOT can supply.
For the current for the extension units, fingerprint unit, bar code reader or RFID controller, and the current that the GOT can supply, refer to the following manual.



GT Designer2 Version □ Screen Design Manual

3.2.3 GT1575V-S, GT1575-S, GT1575-V, GT1575-VN, GT1572-VN

Item		Specifications			
		GT1575V-STBA, GT1575V-STBD	GT1575-STBA, GT1575-STBD	GT1575-VTBA, GT1575-VTBD	GT1575-VNBA, GT1575-VNBD, GT1572-VNBA, GT1572-VNBD
Display section *1	Type	TFT color liquid crystal (LCD of high intensity and wide angle view)			TFT color liquid crystal
	Screen size	10.4"			
	Resolution	800×600dots		640×480dots	
	Display size	211(8.31)(W)×158(6.22)(H)[mm](inch)			
	Display character	16-dot standard font: 50 characters × 37 lines (2byte characters) 12-dot standard font: 66 characters × 50 lines (2byte characters)		16-dot standard font:40 characters × 30 lines (2byte characters) 12-dot standard font:53 characters × 40 lines (2byte characters)	
	Display color	65536color*2			GT1575-VN: 256color GT1572-VN: 16color
	Display angle	Left/Right/Top/Bottom: 85 degrees		Left/ Right/Top/ Bottom: 85 degrees	Left/Right:45 degrees Top:30 degrees Bottom:20 degrees
	Intensity of LCD only	400[cd/m ²]		380[cd/m ²]	200[cd/m ²]
	Intensity adjustment	8-level adjustment			4-level adjustment
	Life	Approx. 50,000 h (Operating ambient temperature: 25°C)		Approx. 41,000 h (Operating ambient temperature:25°C)	
Backlight		Cold cathode fluorescent tube (replaceable) backlight shutoff detection function is included. Backlight off/screen saving time can be set.			
	Life*3	Approx. 40,000 h or longer (Time when display luminance reaches 50% at the operating ambient temperature of 25°C)			
Touch panel	Type	Matrix resistive film			
	Number of touch keys	1,900 objects/screen (38 lines × 50 columns)		1,200 objects/screen (30 lines × 40 columns)	
	Key size	Minimum 16 × 16 dots (16 × 8 dots for the last line only)(per key)		Minimum 16 × 16 dots (per key)	

(Continued to next page)

Item		Specifications			
		GT1575V-STBA, GT1575V-STBD	GT1575-STBA, GT1575-STBD	GT1575-VTBA, GT1575-VTBD	GT1575-VNBA, GT1575-VNBD, GT1572-VNBA, GT1572-VNBD
Touch panel	Number of objects that can be simultaneously touched	Maximum of 2 objects			
	Life	1 million times or more (operating force 0.98 max.)			
Human sensor	Detection length	None			
	Detection range	None			
	Detection delay time	None			
	Detection temperature	None			
Memory *4	C drive	Built-in flash memory 9Mbytes (for storing project data and OS)		Built-in flash memory 5Mbytes (for storing project data and OS)	
	Life (Number of write times)	100,000 times			
Battery		GT15-BAT lithium battery (Option)			
	Backup target	Clock data and maintenance time notification data			
	Life	Approx. 5 years (Operating ambient temperature of 25°C)			
Built-in interface	RS-232*6	RS-232, 1ch Transmission speed:115,200/57,600/38,400/19,200/9,600/4,800 bps Connector shape:D-sub 9-pin (Male) Application:For communicating with a controller or connecting a personal computer (Project data upload/download, OS installation, FA transparent function)			
	USB	USB (Full Speed 12 Mbps), Device, 1ch Connector shape:TYPE Mini-B Application:For connecting a personal computer (Project data upload/download, OS installation and FA transparent function)			
	CF card	Compact flash slot, 1ch Connector shape: TYPE I Application: Data transfer, data storage, GOT startup			

(Continued to next page)

Item		Specifications			
		GT1575V-STBA, GT1575V-STBD	GT1575-STBA, GT1575-STBD	GT1575-VTBA, GT1575-VTBD	GT1575-VNBA, GT1575-VNBD, GT1572-VNBA, GT1572-VNBD
Built-in interface	Option function board	For option function board mounting, 1ch			
	Multi-color display board	For multi-color display board mounting, 1ch			Cannot be used. (Even installed, 65536 colors will not be displayed.)
	Extension unit* ⁶	For communication unit/option unit mounting, 2ch			
Buzzer output		Single tone (tone length adjustable)			
Protective structure		Outside the enclosure: IP67* ⁵ Inside the enclosure: IP2X			
External dimensions (Excluding USB environmental protective cover)		303(11.93)(W)×214(8.43)(H)×49(1.93)(D)[mm](inch)			
Panel cutting dimensions		289(11.38)(W)×200(7.87)(H)[mm](inch)			
Weight		2.3 kg(5.1lb) (mounting fixtures are not included)	2.4 kg(5.3lb) (mounting fixtures are not included)		2.3 kg(5.1lb) (mounting fixtures are not included)
Compatible software package (GT Designer2 Version)		2.30G or later	GT1575-STBA: 2.04E or later GT1575-STBD: 2.17T or later	GT1575-VTBA: 2.04E or later GT1575-VTBD: 2.17T or later	2.17T or later

*1 Bright dots (always lit) and dark dots (unlit) may appear on a liquid crystal display panel due to its characteristics. It is impossible to completely avoid this symptom, as the liquid crystal display comprises of a great number of display elements. Please note that these dots appear due to its characteristic and are not caused by product defect.

*2 With the hardware version indicated below, it will be 256 colors when the multi-color display board is not installed.

For how to confirm the function version, refer to the following.



Appendix Confirming of Versions and Conformed Standards

Item	Model	Function version
GT1575	GT1575-STBA	A
	GT1575-STBD	A
	GT1575-VTBA	A
	GT1575-VTBD	A

*3 The GOT screen saving/backlight off function prevents images from becoming permanently etched on the display screen and increases the backlight life.

*4 ROM in which new data can be written without deleting the written data.

*5 Compliant with IP67 when the USB environmental protection cover is attached. Compliant with IP2X at the USB interface only when a USB cable is connected. Note that this does not guarantee all users' operation environment.

*6 For using multiple extension units, a fingerprint unit, a bar code reader, or a RFID controller, the total current for the extension units, fingerprint unit, bar code reader, or RFID controller must be within the current that the GOT can supply.

For the current for the extension units, fingerprint unit, bar code reader or RFID controller, and the current that the GOT can supply, refer to the following manual.



GT Designer2 Version □ Screen Design Manual

3.2.4 GT1565-V, GT1562-VN

Item		Specifications	
		GT1565-VTBA, GT1565-VTBD	GT1562-VNBA, GT1562-VNBD
Display section *1	Type	TFT color liquid crystal (LCD of high intensity and wide angle view)	TFT color liquid crystal
	Screen size	8.4"	
	Resolution	640×480dots	
	Display size	171(6.73)(W)×128(5.04)(H)[mm](inch)	
	Display character	16-dot standard font: 40 characters × 30 lines (2byte characters) 12-dot standard font: 53 characters × 40 lines (2byte characters)	
	Display color	65536color ^{*2}	16color
	Display angle	Left/Right: 65 degrees Top : 50 degrees Bottom : 60 degrees	Left/Right: 45 degrees Top : 20 degrees Bottom : 20 degrees
	Intensity of LCD only	380[cd/m ²]	150[cd/m ²]
	Intensity adjustment	8-level adjustment	4-level adjustment
	Life	Approx. 41,000 h (Operating ambient temperature: 25°C)	
Backlight	Cold cathode fluorescent tube (replaceable) backlight shutoff detection function is included. Backlight off/screen saving time can be set.		
	Life ^{*3}	Approx. 40,000 h or longer (Time when display luminance reaches 50% at the operating ambient temperature of 25°C)	
Touch panel	Type	Matrix resistive film	
	Number of touch keys	1,200 objects/screen (30 lines × 40 columns)	
	Key size	Minimum 16 × 16 dots (per key)	
	Number of objects that can be simultaneously touched	Maximum of 2 objects	
	Life	1 million times or more (operating force 0.98N max.)	
Human sensor	Detection length	None	
	Detection range	None	
	Detection delay time	None	
	Detection temperature	None	

(Continued to next page)

Item		Specifications	
		GT1565-VTBA, GT1565-VTBD	GT1562-VNBA, GT1562-VNBD
Memory ⁴	C drive	Built-in flash memory 9Mbytes (for string project data and OS)	Built-in flash memory 5Mbytes (for string project data and OS)
	Life (Number of write times)	100,000 times	
Battery		GT-15BAT lithium battery (Option)	
Backup target		Clock data and maintenance time notification data	
Life		Approx. 5 years (Operating ambient temperature of 25°C)	
Built-in interface	RS-232 ⁶	RS-232, 1ch Transmission speed:115,200/57,600/38,400/19,200/9,600/4,800 bps Connector shape:D-sub 9-pin (Male) Application: For communicating with a controller or connecting a personal computer (Project data upload/download, OS installation and FA transparent function)	
	USB	USB (Full Speed 12 Mbps), Device, 1ch Connector shape:TYPE Mini-B Application:For connecting a personal computer (Project data upload/download, OS installation and FA transparent function)	
	CF card	Compact flash slot, 1ch Connector shape: TYPE I Application: Data transfer, data storage, GOT startup	
	Option function board	For option function board mounting, 1ch	
	Multi-color display board	For multi-color display board mounting, 1ch	Cannot be used. (Even installed, 65536 colors will not be displayed.)
Built-in interface	Extension unit ⁶	For communication unit/option unit mounting, 2ch	
Buzzer output		Single tone (tone length adjustable)	
Protective structure		Outside the enclosure: IP67 ⁵ Inside the enclosure: IP2X	
External dimensions (Excluding USB environmental protective cover)		241(9.49)(W)× 190(7.48)(H)× 52(2.05)(D)[mm](inch)	
Panel cutting dimensions		227(8.94)(W)× 176(6.93)(H)[mm](inch)	
Weight		1.9 kg(4.2lb) (mounting fixtures are not included)	
Compatible software package (GT Designer2 Version)		GT1565-VTBA:2.04E or later, GT1565-VTBD:2.17T or later	2.17T or later

- *1 Bright dots (always lit) and dark dots (unlit) may appear on a liquid crystal display panel due to its characteristics. It is impossible to completely avoid this symptom, as the liquid crystal display comprises of a great number of display elements. Please note that these dots appear due to its characteristic and are not caused by product defect.
- *2 With the hardware version indicated below, it will be 256 colors when the multi-color display board is not installed.
For how to confirm the function version, refer to the following.



Appendix Confirming of Versions and Conformed Standards

Item	Model	Function version
GT1565	GT1565-VTBA	A
	GT1565-VTBD	A

- *3 The GOT screen saving/backlight off function prevents images from becoming permanently etched on the display screen and increases the backlight life.
- *4 ROM in which new data can be written without deleting the written data.
- *5 Compliant with IP67 when the USB environmental protection cover is attached. Compliant with IP2X at the USB interface only when a USB cable is connected. Note that this does not guarantee all users' operation environment.
- *6 For using multiple extension units, a fingerprint unit, a bar code reader, or a RFID controller, the total current for the extension units, fingerprint unit, bar code reader, or RFID controller must be within the current that the GOT can supply.
For the current for the extension units, fingerprint unit, bar code reader or RFID controller, and the current that the GOT can supply, refer to the following manual.



GT Designer2 Version □ Screen Design Manual

3.2.5 GT1555-V, GT1555-Q, GT1550-Q

Item		Specifications			
		GT1555-VTBD	GT1555-QTBD	GT1555-QSBD	GT1550-QLBD
Display section *1	Type	TFT color liquid crystal (LCD of high intensity and wide angle view)		STN color liquid crystal	STN monochrome liquid crystal
	Screen size	5.7"			
	Resolution	640×480dots	320×240dots		
	Display size	115(4.53)(W)×86(3.39)(H)[mm](inch)			
	Display character	16-dot standard font: 40 characters × 30 lines (2byte characters) 12-dot standard font: 53 characters × 40 lines (2byte characters)	16-dot standard font: 20 characters × 15 lines (2byte characters) 12-dot standard font: 26 characters × 20 lines (2byte characters)		
	Display color	65536color ^{*2}		4096color	monochrome (16-level)
	Display angle	Left/Right: 80 degrees Top: 80 degrees Bottom: 70 degrees	Left/Right: 70 degrees Top: 70 degrees Bottom: 50 degrees	Left/Right: 55 degrees Top: 65 degrees Bottom: 70 degrees	Left/Right: 45 degrees Top: 20 degrees Bottom: 40 degrees
	Intensity of LCD only	350[cd/m ²]	400[cd/m ²]	380[cd/m ²]	220[cd/m ²]
	Intensity adjustment	8-level adjustment			
	Contrast adjustment	None		16-level adjustment	
	Life	Approx. 50,000 h (Operating ambient temperature: 25°C)			

(Continued to next page)

Item	Specifications			
	GT1555-VTBD	GT1555-QTBD	GT1555-QSBD	GT1550-QLBD
Backlight	Cold cathode fluorescent tube (nonreplaceable) backlight shutoff detection function is included. Backlight off/screen saving time can be set.			
	Life*2	Approx. 75,000 h or longer (Time when display luminance reaches 50% at the operating ambient temperature of 25°C)		Approx. 58,000 h or longer (Time when display luminance reaches 50% at the operating ambient temperature of 25°C)
Touch panel	Type	Matrix resistive film		
	Number of touch keys	1200 objects/screen (Matrix structure of 30 lines × 40 columns)	300 objects/screen (Matrix structure of 15 lines × 20 columns)	
	Key size	Minimum 16 × 16 dots (per key)		
Touch panel*6	Number of objects that can be simultaneously touched	Maximum of 2 objects		
	Life	1 million times or more (operating force 0.98N max.)		
Human sensor	Detection length	None		
	Detection range	None		
	Detection delay time	None		
	Detection temperature	None		
Memory*3	C drive	Built-in flash memory 9Mbytes (for string project data and OS)		
	Life (Number of write times)	100,000 times		
Battery	GT15-BAT lithium battery (Option)			
	Backup target	Clock data and maintenance time notification data		
	Life	Approx. 5 years (Operating ambient temperature of 25°C)		

(Continued to next page)

Item		Specifications			
		GT1555-VTBD	GT1555-QTBD	GT1555-QSBD	GT1555-QLBD
Built-in interface	RS-232 ^{*5}	RS-232, 1ch Transmission speed:115,200/57,600/38,400/19,200/9,600/4,800 bps Connector shape:D-sub 9-pin (Male) Application: For communicating with a controller or connecting a personal computer (Project data upload/download, OS installation and FA transparent function)			
	USB	USB (Full Speed 12 Mbps), Device, 1ch Connector shape:TYPE Mini-B Application:For connecting a personal computer (Project data upload/download, OS installation and FA transparent function)			
	CF card	Compact flash slot, 1ch Connector shape: TYPE I Application: Data transfer, data storage, GOT startup			
	Option function board	For option function board mounting, 1ch			
	Extension unit ^{*5}	For communication unit/option unit mounting, 1ch			
Buzzer output		Single tone (tone length adjustable)			
Protective structure		Outside the enclosure: IP67 ^{*4} Inside the enclosure: IP2X			
External dimensions (Excluding USB environmental protective cover)		167(6.6)(W)×135(5.3)(H)×56(2.2)(D)[mm](inch)			
Panel cutting dimensions		153(6.0)(W)×121(4.8)(H)[mm](inch)			
Weight		1.1 kg(2.4lb) (mounting fixtures are not included)			
Compatible software package (GT Designer2 Version)		2.58L or later	2.32J or later		

- *1 Bright dots (always lit) and dark dots (unlit) may appear on a liquid crystal display panel due to its characteristics. It is impossible to completely avoid this symptom, as the liquid crystal display comprises of a great number of display elements. Flickers may be observed depending on the display color. Please note that these dots and flickers appear due to its characteristic and are not caused by product defect.
- *2 The GOT screen saving/backlight off function prevents images from becoming permanently etched on the display screen and increases the backlight life.
- *3 ROM in which new data can be written without deleting the written data.
- *4 Compliant with IP67 when the USB environmental protection cover is attached. Compliant with IP2X at the USB interface only when a USB cable is connected. Note that this does not guarantee all users' operation environment.
- *5 For using multiple extension units, a fingerprint unit, a bar code reader, or a RFID controller, the total current for the extension units, fingerprint unit, bar code reader, or RFID controller must be within the current that the GOT can supply.
For the current for the extension units, fingerprint unit, bar code reader or RFID controller, and the current that the GOT can supply, refer to the following manual.
 GT Designer2 Version Screen Design Manual
- *6 The GT1555-V can be operated with a stylus pen.
With a stylus pen, small-sized touch switches can be certainly operated.
Use a stylus pen that satisfies the following specifications.
 - Material: Polyacetal resin
 - Pen tip radius: 0.8mm or more

3.3 Power Supply Specifications

- The following describes the power supply specifications for the GT15.
-  3.3.1 For GOTs powered from the 100 to 240VAC power supply
 - 3.3.2 For GOTs powered from the 24VDC power supply

Remarks

Operation at momentary failure

- If an instantaneous power failure occurs in the power supply and continues for more than the permissible period, the GOT will be reset.
- Make sure to power on the unit more than 5 seconds after power-off.

3.3.1 For GOTs powered from the 100 to 240VAC power supply

Item	Specifications		
	GT1595-XTBA	GT1585V-STBA, GT1585-STBA	GT1575V-STBA, GT1575-STBA, GT1575-VTBA, GT1575-VNBA, GT1572-VNBA, GT1565-VTBA, GT1562-VNBA
Input power supply voltage	100 to 240VAC (+10% -15%)		
Input frequency	50/60Hz \pm 5%		
Input max. apparent power	110VA (maximum load)		
Power consumption	56W or less	41W or less	39W or less
	At backlight off	30W or less	28W or less
Inrush current	50A or less (4ms) (maximum load)	45A or less (4ms) (maximum load)	40A or less (4ms) (maximum load)
Permissible instantaneous power failure time	20ms or less (100VAC or more)		
Noise immunity	1,500Vp-p noise voltage, 1 μ s noise width (when measuring with a noise simulator under 25 to 60Hz noise frequency)		
Dielectric withstand voltage	1500VAC for 1 minute across power terminals and earth		
Insulation resistance	10M Ω or more across power terminals and earth by a 500VDC insulation resistance tester		
Applicable wire size	0.75 to 2 [mm ²]		
Applicable solderless terminal	Solderless terminal for M3 screw RAV1.25-3, V2-S3.3, V2-N3A, FV2-N3A		
Applicable tightening torque (Terminal block terminal screw)	0.5 to 0.8 [N•m]		

3.3.2 For GOTs powered from the 24VDC power supply

Item	Specifications						
	GT1595-XTBD	GT1585 V-STBD, GT1585-STBD	GT1575 V-STBD, GT1575-STBD, GT1575-VTBD, GT1575-VNBD, GT1572-VNBD, GT1565-VTBD, GT1562-VNBD	GT1555-V	GT1555-QTBD	GT1555-QSBD	GT1550-QLBD
Input power supply voltage	24VDC (+25%, -20%)						
Power consumption	57W or less (2380mA /24VDC)	43W or less (1790mA /24VDC)	41W or less (1710mA /24VDC)	19W or less (790mA/ 24VDC)	18W or less (750mA/ 24VDC)	17W or less (710mA/ 24VDC)	15W or less (620mA/ 24VDC)
At backlight off	32W or less (1330mA /24VDC)	30W or less (1250mA/24VDC)		14W or less (580mA/ 24VDC)	13W or less (540mA/24VDC)		
Inrush current	100A or less (4ms)(maximum load)	115A or less (1ms)(maximum load)		67A or less (1ms)(maximum load)	60A or less (1ms)(maximum load)		
Permissible instantaneous power failure time	10 ms or less						
Noise immunity	500Vp-p noise voltage, 1 μ s noise width (when measuring with a noise simulator under 25 to 60Hz noise frequency)						
Dielectric withstand voltage	500VDC for 1 minute across power terminals and earth						
Insulation resistance	10M Ω or more across power terminals and earth by a 500VDC insulation resistance tester						
Applicable wire size	0.75 to 2 [mm ²]						
Applicable solderless terminal	Solderless terminal for M3 screw RAV1.25-3, V2-S3.3, V2-N3A, FV2-N3A						

(Continued to next page)

Item	Specifications						
	GT1595-XTBD	GT1585 V-STBD, GT1585-STBD	GT1575 V-STBD, GT1575-STBD, GT1575-VTBD, GT1575-VNBD, GT1572-VNBD, GT1565-VTBD, GT1562-VNBD	GT1555-V	GT1555-QTBD	GT1555-QSBD	GT1550-QLBD
Applicable tightening torque (Terminal block terminal screw)	0.5 to 0.8 [N·m]						

3.4 External Dimensions

(1) GT1595

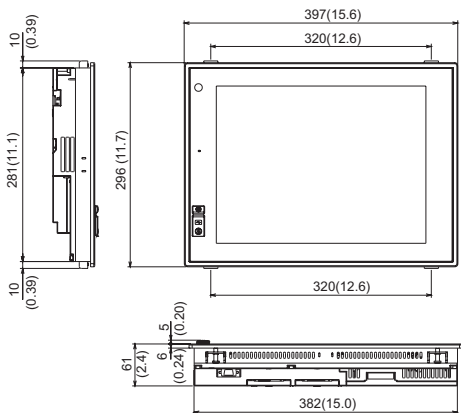

Unit:mm(inch)

(2) GT1585

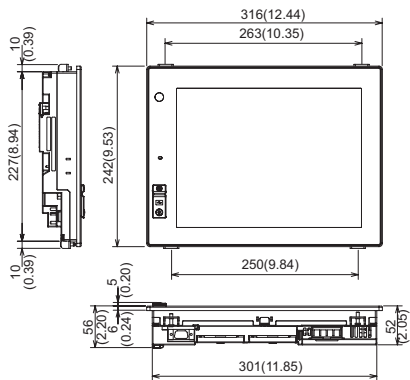

Unit: mm (inch)

(3) GT157 □

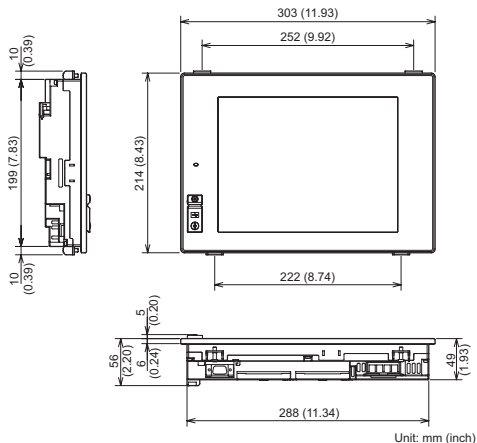

(4) GT156 □

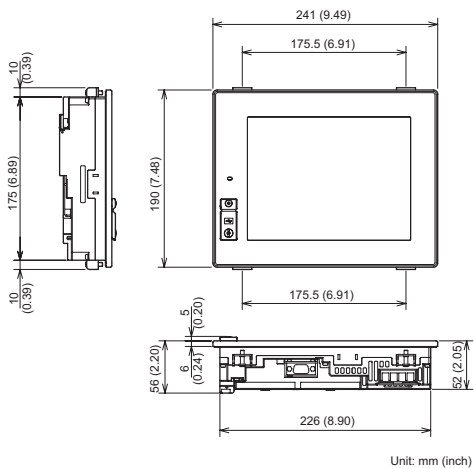

(5) GT155 □

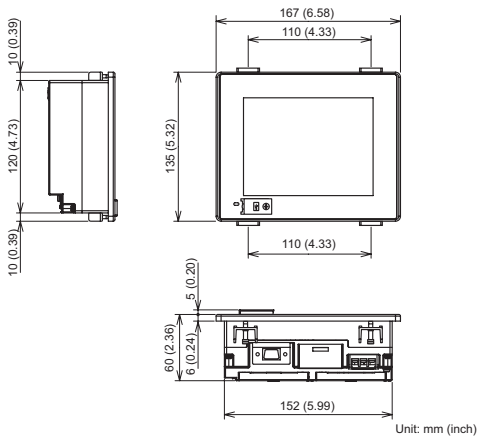

4. EMC and Low Voltage Directive

For the products sold in European countries, the conformance to the EMC Directive, which is one of the European Directives, has been a legal obligation since 1996.

Also, conformance to the Low Voltage Directive, another European Directives, has been a legal obligation since 1997.

Manufacturers who recognize their products must conform to the EMC and Low Voltage Directive are required to declare that their products conform to these Directives and put a "CE mark" on their products.

When manufacturers produce machineries using the GOT, they should finally decide the EMC and low voltage directives conformance method or judge if the manufactured machineries conform to these directives.

For the EMC and low voltage directives conformance method for the GOT1000 series, refer to the GT15 User's Manual.

The above manual can be downloaded from the Information site for Mitsubishi industrial automation products MELFANSweb website.

Also, conformance to the EMC Directive of the GOT1000 series can be confirmed with the MELFANSweb website.

For latest information, please confirm on the MELFANSweb website.

(MELFANSweb website: <http://wwwf2.mitsubishielectric.co.jp/english/index.html>)

Mitsubishi GOTs conform to the following standards:

EN61131-2: Programmable controllers - Equipment requirements and tests

EN60950-1: Safety of Information Technology Equipment

5. Installation

5.1 Control Panel Inside Dimensions for Mounting GOT

Mount the GOT onto the control panel while considering the control panel inside dimensions.

POINT

Applicable cable

Some cables may need to be longer than the specified dimensions when connecting to the GOT.

Therefore, consider the connector dimensions and bending radius of the cable as well for installation.

5.2 Panel Cutting Dimensions

Make holes in the panel according to the dimensions list below.

Also, ensure 10mm spaces in upper and lower parts of the panel for mounting fixtures.

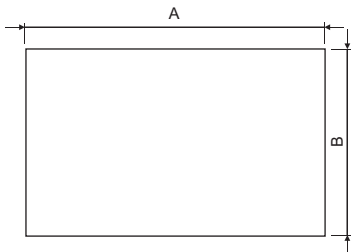

* Panel thickness: 2 to 4 mm or less

GOT	A [mm](inch)	B [mm](inch)
GT1595	383.5(15.10) ^{+2(0.08)} ₀₍₀₎	282.5(11.12) ^{+2(0.08)} ₀₍₀₎
GT1585	302(11.89) ^{+2(0.08)} ₀₍₀₎	228(8.98) ^{+2(0.08)} ₀₍₀₎
GT157□	289(11.38) ^{+2(0.08)} ₀₍₀₎	200(7.87) ^{+2(0.08)} ₀₍₀₎
GT156□	227(8.94) ^{+2(0.08)} ₀₍₀₎	176(6.93) ^{+2(0.08)} ₀₍₀₎
GT155□	153(6.02) ^{+2(0.08)} ₀₍₀₎	121(5) ^{+2(0.08)} ₀₍₀₎

5.3 Mounting Position

When mounting the GOT, the following clearances must be left from the other device.

Some cables may need to be longer than the specified dimensions when connecting to the GOT.

Therefore, consider the connector dimensions and bending radius of the cable as well for installation.

For the lead-in allowance for cables at the bottom of the GOT, refer to the following.

 GT15 User's Manual

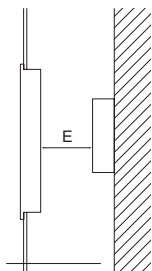
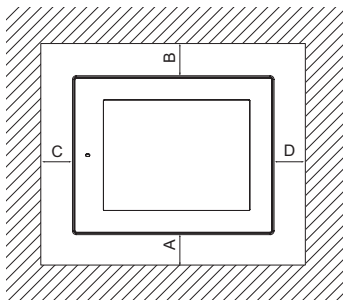

Panel thickness: 2 to 4mm
(0.08 to 0.16inch)

Type		GT1595	GT1585	GT157□	GT156□	GT155□
A	GOT	50(1.97) or more [20(0.79) or more]		50(1.97) or more [31(1.22) or more]	50(1.97) or more [36(1.47) or more]	65(2.26) or more
	Bus connection unit is fitted	50(1.97) or more [20(0.79) or more]		50(1.97) or more [31(1.22) or more]	50(1.97) or more [36(1.47) or more]	65(2.26) or more
	Serial communication unit fitted	50(1.97) or more [20(0.79) or more]		50(1.97) or more [31(1.22) or more]	50(1.97) or more [36(1.47) or more]	65(2.26) or more
	RS-422 Conversion unit is fitted	50(1.97) or more	51(2.01) or more	68(2.68) or more	73(2.87) or more	—

(Continued to next page)

Type	GT1595	GT1585	GT157□	GT156□	GT155□
Ethernet communication unit is fitted	50 (1.97) or more [20 (0.79) or more]				50 (1.97) or more [40 (1.58) or more]
MELSECNET/10 communication unit (coaxial) is fitted	50 (1.97) or more [20 (0.79) or more]				—
CC-Link communication unit (GT15-75J61BT13-Z) fitted	50 (1.97) or more [20 (0.79) or more]				—
CC-Link communication unit (GT15-J61BT13) fitted	50 (1.97) or more [20 (0.79) or more]				50(1.97) or more [32(1.26) or more]
MELSECNET/10 communication unit (optical) fitted	50(1.97) or more [20(0.79) or more]	50(1.97) or more [26(1.02) or more]	50(1.97) or more [43(1.69) or more]	50(1.97) or more [48(1.89) or more]	—
MELSECNET/H communication unit (coaxial) fitted	50(1.97) or more [20(0.79) or more]	50(1.97) or more [24(0.95) or more]	50(1.97) or more [38(1.5) or more]	50(1.97) or more	72(2.84) or more
MELSECNET/H communication unit (optical) fitted	50 (1.97) or more [20 (0.79) or more]				
CC-Link IE controller network communication unit fitted	50 (1.97) or more [20 (0.79) or more]				
printer unit fitted	50(1.97) or more [20(0.79) or more]		50(1.97) or more [31(1.22) or more]	50(1.97) or more [36(1.47) or more]	50(1.97) or more
Video input unit fitted	—	50 (1.97) or more [20 (0.79) or more]		—	—
RGB input unit fitted	—	50 (1.97) or more [20 (0.79) or more]		—	—
Video/RGB input unit fitted	—	50 (1.97) or more [20 (0.79) or more]		—	—
RGB output unit fitted	—	50 (1.97) or more [20 (0.79) or more]		—	—
CF card unit	50 (1.97) or more [20 (0.79) or more]		50 (1.97) or more [31 (1.22) or more]	50 (1.97) or more [36 (1.47) or more]	65(2.56) or more
CF card extension unit	50 (1.97) or more [20 (0.79) or more]		50 (1.97) or more [31 (1.22) or more]	50 (1.97) or more [36 (1.47) or more]	65(2.56) or more

(Continued to next page)

Type		GT1595	GT1585	GT157□	GT156□	GT155□
A	Output/Input unit	50 (1.97) or more [20 (0.79) or more]		50 (1.97) or more [31 (1.22) or more]	50 (1.97) or more [36 (1.47) or more]	65(2.56) or more
	Sound Interface Unit	50 (1.97) or more [20 (0.79) or more]		50 (1.97) or more [31 (1.22) or more]	50 (1.97) or more [36 (1.47) or more]	65(2.56) or more
B		80(3.15) or more [20(0.79) or more]				
C	(When the CF card is not used)	50(1.97) or more [20(0.79) or more]				
	(When the CF card is used)	50(1.97) or more [20(0.79) or more]				100(3.94) or more
D		50(19.7) or more [20(0.79) or more]				
E		100(39.4) or more [20(0.79) or more]				

Unit: mm (inch)

The values enclosed in parenthesis apply to the case where no other equipment generating radiated noise (such as a contactor) or heat is installed.

However, keep the ambient temperature of the GOT to 55°C or lower even in such a case.

The required lead-in allowance for cables may be larger than the size of A above depending on the unit or cable used.

5.4 Control Panel Inside Temperature and Mounting Angle

When mounting the main unit to a control panel or similar, set the display section as shown below.

- When the temperature inside the control panel is 40 to 55°C or less, the mounting angle should be in the range 60 to 105 degrees.

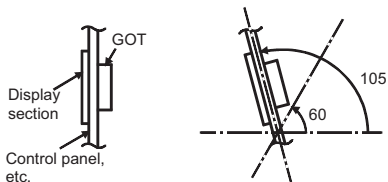

- The GOT will be deteriorated earlier if it is used at the mounting angle other than the above. Therefore, the temperature inside the control panel should be within 40°C.
- *: When mounting MELSECNET/H communication unit (GT15-J71LP23-25, GT15-J71BR13) or CC-Link communication unit (GT15-J61BT13), the operating ambient temperature must be reduced 5°C against the maximum values described in general specifications.

5.5 Installation Procedure

The GOT mounting procedure is as follows.

For the panel cutting dimensions of each GOT, refer to the following.

 5.2 Panel Cutting Dimensions

- (1) Insert the GOT into the panel opening from the front side.

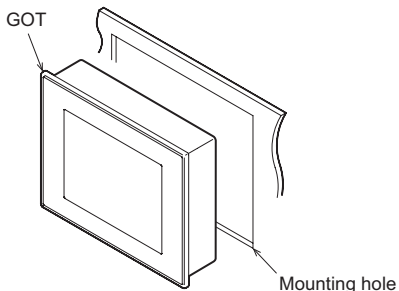

- (2) Place the mounting fixtures (included with GOT) on the mounting fixture attaching part of the GOT, and fix them by tightening the mounting screws in the torque range of 0.36 to 0.48N·m.
(Failure to do so may distort the panel and make a surface waviness on the protective sheet.)

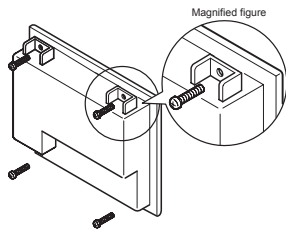
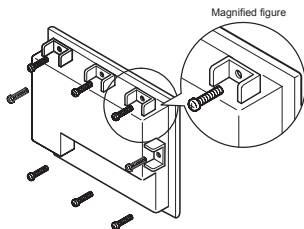

- For GT1595-X: Fix the GOT with 8 mounting fixtures.

- For other than GT1595-X: Fix the GOT with 4 mounting fixtures.

- (3) A protection film is attached on the display section of GOT prior to shipment.
Remove the film when the installation is completed.

6.Wiring

6.1 Wiring Precautions

 **DANGER**

- Before starting wiring, always switch off the GOT power externally in all phases.
Not doing so may cause an electric shock, product damage or malfunction.

 **CAUTION**

- Please make sure to ground FG terminal, LG terminal, and protective ground terminal of the GOT power supply section by applying Class D Grounding (Class 3 Grounding Method) or higher which is used exclusively for the GOT. Not doing so may cause an electric shock or malfunction.
- Correctly wire the GOT power supply section after confirming the rated voltage and terminal arrangement of the product.
Not doing so can cause a fire or failure.
- Tighten the terminal screws of the GOT power supply section in the specified torque range. Undertightening can cause a short circuit or malfunction. Overtightening can cause a short circuit or malfunction due to the damage of the screws or the GOT.
- Exercise care to avoid foreign matter such as chips and wire offcuts entering the GOT. Not doing so can cause a fire, failure or malfunction.

This section describes wiring to the GOT power supply section.
For the connection to a controller, refer to the following manual.



GOT1000 Series Connection Manual

General preventive measures against noise

There are two kinds of noises: Radiated noise that is transmitted into the air and Conductive noise that is directly transmitted along connected lines. Countermeasures must be taken considering both kinds of noises and referring to the following 3 points.

(1) Protecting against noise

- (a) Keep signal lines away from noise sources such as a power cable or a high-power drive circuit.
- (b) Shield the signal lines.

(2) Reducing generated noise

- (a) Use a noise filter, etc. to reduce the level of the noise generated due to a source such as a high-power motor drive circuit.
- (b) Attach a surge suppressor on the terminal of the molded case circuit breaker (MCCB), electromagnetic contactor, relay, solenoid valve, or induction motor to suppress the noise.

(3) Releasing noise to the ground

- (a) Make sure to connect the ground cable to the ground.
- (b) Use a short and thick cable to lower its ground resistance.
- (c) Ground the power system and the control system separately.

6.2 Power Supply Wiring

- Make wiring connections to the power supply, I/O equipment and power equipment separately by system as shown below. When frequent noise is identified, connect an isolation transformer.

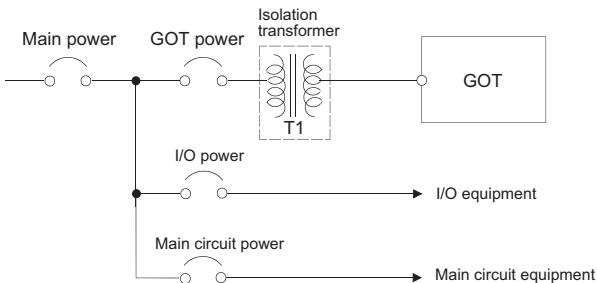

Wiring diagram for power supply

- Twist 100V AC, 200V AC or 24V DC cable as closely as possible and connect the cable of the minimum length between modules. Also, use the thickest cable as possible (Max. 2mm^2) to minimize the voltage drop. Use M3 solderless terminals and securely tighten them with a tightening torque of 0.5 to $0.8\text{N}\cdot\text{m}$ so that no problem will result.
- Separate the 100V AC, 200V AC or 24V DC cable from the main circuit lines (high voltage, large current) and/or I/O signal lines. Keep a distance of 100mm or more.
- As measures against surge due to lightning, connect a lightning surge absorber as shown below.

Lightning surge absorber connection

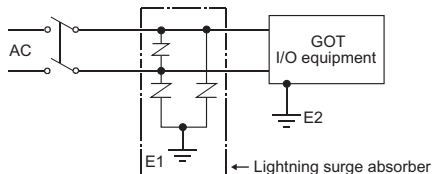

POINT

1. Separate the grounding of the lightning surge absorber (E1) from the grounding of the GOT (E2).
2. Select an appropriate lightning surge absorber so that the supply voltage does not exceed the maximum allowable circuit voltage of the surge absorber even when it rises to the maximum.

6.3 Wiring to GOT Power Section

This section provides an example for connecting power cables and ground cables to the power terminals situated on the back of the GOT.

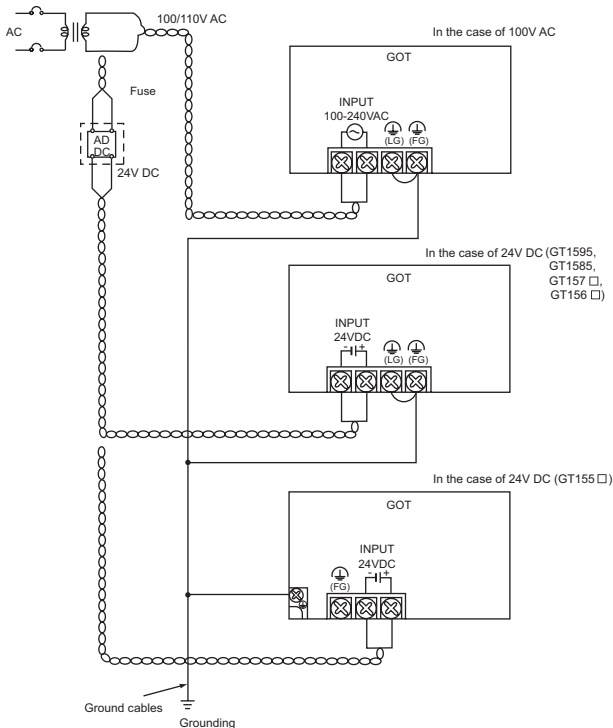

POINT

- (1) Precautions for wiring to the power supply section
- For 100V AC, 200V AC or 24V DC cable, use the thickest cable as possible (Max.2mm²) and start twisting them at the position closest to the connected terminals.
To prevent a short circuit due to loose screws, use the solderless terminal with insulation sleeve.
 - When connection is made between LG and FG terminals, be sure to connect them to the ground.
Otherwise, the system becomes susceptible to noise.
Since the LG terminal has potential equal to a half of the input voltage, touching the terminal may lead to an electric shock.
 - When grounding the GT155 □ , ground it with the ground terminal equipped at the lower-left corner on the GOT main unit back face.(Refer to the previous page.)
Connect only the ground cables of the bus connection cable and the CF card extension unit connection cable to the FG terminal.
- (2) Wiring the power section of the GT155 □ when using an extension unit
- Be sure to wire the power section before connecting a cable to the extension unit.
If connecting a cable to the extension unit before wiring the power section, the terminal block of the power section will be blocked by the cable and the power section cannot be wired.

6.4 Grounding

6.4.1 Grounding the GOT

1 About grounding

Perform the following three items for grounding.

- Independent grounding should be performed as possible for the GOT.
Perform grounding works. (grounding resistance 100Ω or less)
- When independent grounding cannot be performed for the GOT, perform "(2) Shared grounding" shown below.

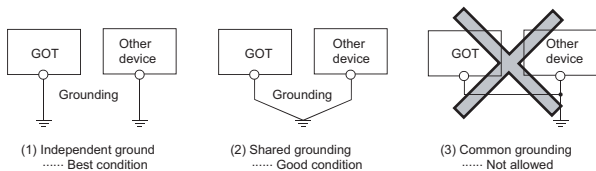

- Use a cable of 2mm² or more for grounding when performing (1) or (2) above.
Ground the cable at a point as close to the GOT as possible to make the ground cable short.

2 Grounding examples

(1) Independent grounding (Best)

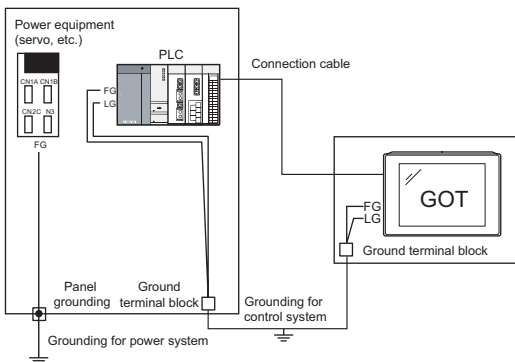

- * For the control equipment, ground the system at one end. Especially for the control equipments communicating each other, ground the system at one end.

(2) Shared grounding (Good)

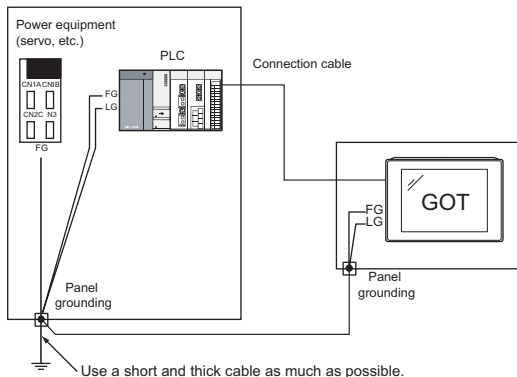

- * Ground the system at one end.
To prevent noise from entering the GOT, use a short and thick wire for grounding between the ground and the panel to ensure lower ground resistance.

(3) Common grounding (Not allowed)

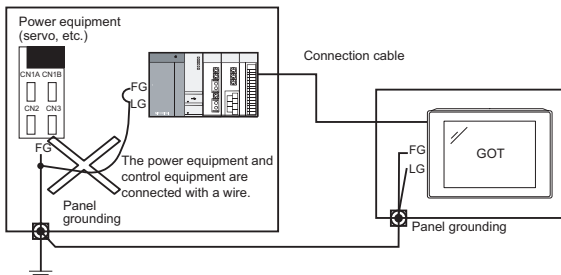

- * Do not connect the ground cables of the power equipment and control equipment with a wire.
If the cables are connected, noise from the power equipment may influence the control equipment, causing malfunction.

3 Recommended terminal shape

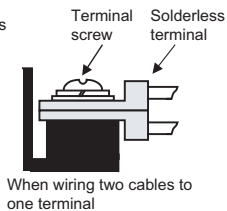
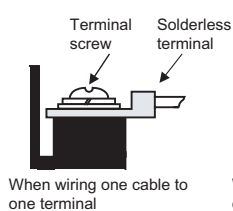
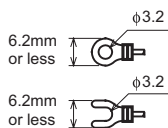

Applicable solderless terminal

RAV1.25- 3, V2- S3.3, V2- N3A, FV2- N3A

6.4.2 Wiring-related malfunction causes and the measures examples

The malfunction causes in grounding the GOT include potential difference caused by groundings and noise.

Potential difference and noise may be reduced by taking the following measures.

1 Wiring of GOT's ground cable and power line

When the ground cable and power line of the GOT are installed together, the GOT may malfunction due to noise.

Separating the ground cable and power line of the GOT in wiring reduces the influence of noise.

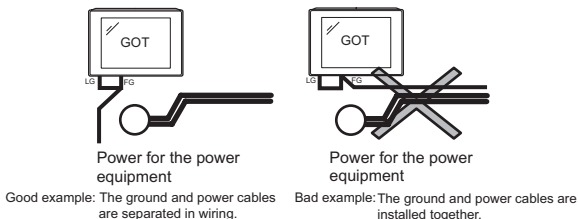

2 Leading of the ground cable from the panel having a control equipment in the panel having the GOT

When a single ground cable is led from the panel having a control equipment such as PLC in the panel having the GOT, the cable may need to be directly connected to the terminal block of the GOT.

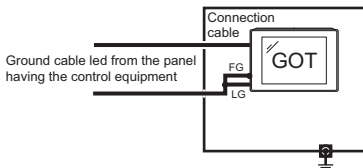

The malfunction occurred by the potential difference caused by the groundings in such a case, may be prevented by reducing the voltage with the following measure example 1, where the voltage is reduced.

Measure example 1 (Refer to the measure examples 1-1 and 1-2 below.)

When any potential difference occurs between the ground cable and the panel having the GOT and the GOT is influenced by the potential difference, connect another ground cable to the panel. When taking of measure 1-1 is difficult since the wiring cannot be done for example, perform the wiring as shown in 1-2.

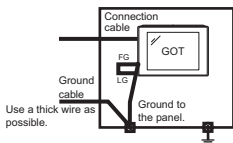

Measure example 1-1

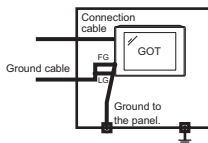

Measure example 1-2

If the GOT is affected by noise when measure example 1 is taken, the influence of noise may be reduced with the following measure example 2.

Measure example 2 (Refer to the measure examples 2-1 and 2-2 below.)

When the noise generated from the panel affects the GOT even if measure example 1 is taken, attach the ferrite core.

When attaching a ferrite core, insert the wire into the hole of the ferrite core several times (approximately three times).

When taking of measure 2-1 is difficult since the wiring cannot be done for example, perform the wiring as shown in 2-2.

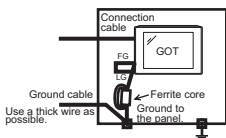

Measure example 2-1

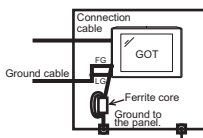

Measure example 2-2

6.5 Panel Inside Wiring, Panel Outside Wiring

6.5.1 Panel inside wiring

In wiring, the power line connected to the power or servo amplifier and the communication cable such as bus connection cable or network cable must not be mixed.

Mixing the power line and communication cable may cause malfunction due to noise.

When using an equipment that may occur surge noise, such as molded case circuit breaker (MCCB), electromagnetic contactor (MC), relay (RA), solenoid valve, or induction motor, using a surge suppressor is effective.

For surge suppressor, refer to the following.

6.6 Attaching Surge Suppressor for Control Equipment

Separated power lines and communication cables

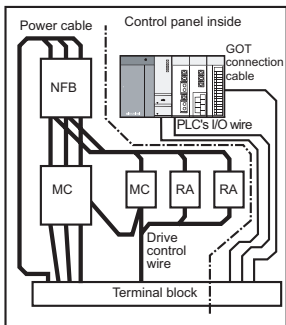

Mixed power lines and communication cables

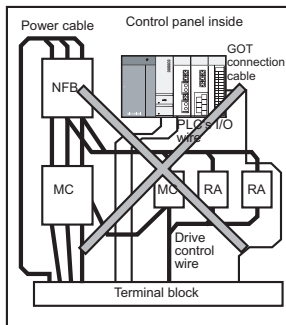

6.5.2 Panel outside wiring

When leading the power line and communication cable outside the panel, open cable holes at two separate places to lead the cables separately out.

If cables are led out through the same cable hole for wiring reasons, the cables are more easily influenced by noise.

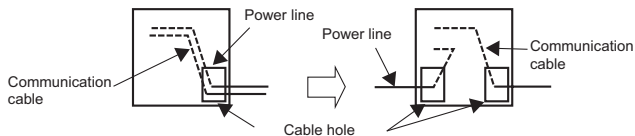

Wiring for leading the power line and communication cable out from the panel

Install the power line and communication cable as apart from each other as possible in the duct.

If the cables are installed closely with each other for wiring reasons, using a separator (made of metal) can make the cables less influenced by noise.

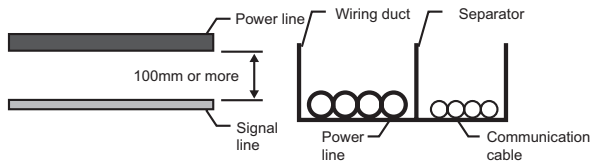

Wiring of power lines and communication cables in the duct

6.6 Attaching Surge Suppressor for Control Equipment

If an improper operation such as communication error occurs in the GOT in synchronization with ON/OFF of a particular control equipment (hereinafter abbreviated to load) such as MCCB, electromagnetic contactor, relay, solenoid valve, or induction motor, the GOT may be influenced by surge noise.

In such a case, install the ground cable or communication cable apart from the load.

If the ground cable or communication cable has to be installed close to the load unavoidably, attaching a surge suppressor is effective.

Attach the surge suppressor at the position closest to the load.

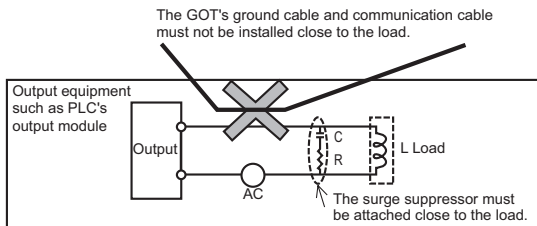

Measures for AC inductive load

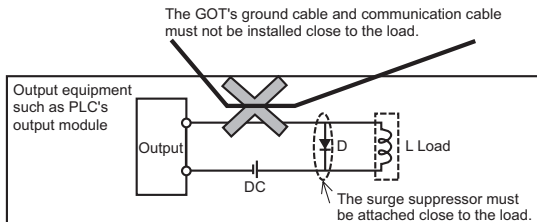

Measures for DC inductive load

6.7 Wiring FG Cable of Bus Connection Cable

This section describes wiring of the FG cable when a PLC CPU is connected to the GOT.

POINT

Cable connected to the PLC CPU

Do not install the connection cable together with the main circuit lines (high voltage, large current) or I/O signal lines.

6.7.1 When connecting QCPU or motion controller CPU (Q series) to the GOT

- Grounding of the FG cable for QCPU and motion controller CPU (Q series) is not necessary since they have no FG wire.

6.7.2 When connecting QnACPU, ACPU, or motion controller CPU (A series) to the GOT

- When using GT15-C EXSS-1 or GT15C BS, perform the grounding in the following steps.

POINT

(1) GOT terminal block

The terminal block layout of a GOT differs depending on the model.

Before wiring, confirm the terminal layout of the GOT to be used.

(2) Ground cables

Up to two ground cables can be connected to the LG and FG terminals of the GOT respectively.

For three or more ground cables, connect the third or later ground cables to the LG terminal.

(1) When using GT15-C □ EXSS-1

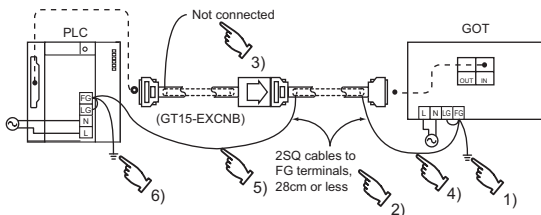

- 1) Connect the LG and FG terminals of the terminal block on the GOT unit power and ground them with a cable.
- 2) Use the GT15-C □ BS's FG cable of 28cm or less.
- 3) Do not connect the GT15-EXCNB's FG ground cable.
- 4) Connect the GT15-C □ BS's FG cable on the GOT side to FG of the GOT unit power's terminal block.
- 5) Connect the GT15-C □ BS's FG cable on the PLC side to FG of the PLC's power supply module.
- 6) Connect the LG and FG terminals of the terminal block on the PLC and ground them with a cable.

(2) When using GT15-C □ BS

For the both side GOTs, connect the LG and FG terminals of the terminal block on the GOT unit power and ground them with a cable.

7.Maintenance and Inspection

7.1 Daily Inspection

Daily inspection items

No.	Inspection Item	Inspection Method	Criterion	Action	
1	GOT mounting status	Check for loose mounting screws.	Securely mounted	Retighten screws within the specified torque range.	
2	Connection status	Loose terminal screws	Retighten screws with screwdriver	Not loose	Retighten terminal screws
		Proximate solderless terminals	Visual check	Proper intervals	Correct
		Loose connectors	Visual check	Not loose	Retighten connector fixing screws
3	Usage status	Dirt on protection sheet	Visual check	Not outstanding	Replace with new one
		Foreign material attachment	Visual check	No foreign matter sticking	Remove, clean

For applicable protective sheet model or replacement procedure, refer to GT15 User's Manual.

7.2 Periodic Inspection

Yearly or half-yearly inspection items

The following inspection should also be performed when equipment has been moved or modified or the wiring changed.

No.	Inspection Item		Inspection Method	Criterion		Action
1	Surrounding environment	Ambient temperature	Make measurement with thermometer or hygrometer	Display section	0 to 40°C	For use in control panel, temperature inside control panel is ambient temperature
		Ambient humidity		Other portions	0 to 55°C	
		Atmosphere	10 to 90%RH			
			No corrosive gas			
2	GOT powered from 100-240VAC power	Power supply voltage check	Measure voltage across terminals of 100-240VAC power.	85AC to 242V		Change supply power
	GOT powered from 24VDC power	Input polarity of 24VDC power	Measure voltage across terminals of 24VDC power.	Left : - Right: +		Change wiring
3	Mounting status	Looseness	Move module	Should be mounted firmly		Retighten screws
		Dirt, foreign matter	Visual check	No dirt, foreign matter sticking		Remove, clean
4	Connection status	Loose terminal screws	Retighten screws with screwdriver	Not loose		Retighten terminal screws
		Proximate solderless terminals	Visual check	Proper intervals		Correct
		Loose connectors	Visual check	Not loose		Retighten connector fixing screws
5	Battery		Check "GOT internal battery voltage status" in "Time setting & display" of the Utility. (Refer to the GT15 User's Manual.)	No alarm appears		Replace with new battery when the current battery has reached the specified life span, even if battery voltage low is not displayed.

7.3 Battery Voltage Low Detection and Battery Replacement

The battery is used for backing up the present time or the maintenance time notification data.

It is recommended that you replace battery periodically.

7.3.1 Applicable battery

The following battery is applicable for GT15□□.

Model	Descriptionm
GT15-BAT	Battery for backup of clock data and maintenance time notification data.

7.3.2 Battery specifications

Item	Specifications
Type	Magnesium manganese dioxide lithium primary battery
Initial voltage	3.0V
Nominal current	1800mAh
Storage life	Approx.5 years (Operating ambient temperature of 25°C)
Total power stoppage time	Refer to Section .
Lithium content	0.49g
Application	For backup of clock data and maintenance time notification data.

Remarks

Refer to the following manual for details of the battery regulations in the EU member countries.

 GT15 User's Manual

7.3.3 Battery replacement procedure

Replace battery periodically by referring to Section 7.3.4 Battery life.

- (1) Keep the GOT power supply on for 10 minutes or more, and turn it off.
(Executes step 2 to 6 within 5 minutes of powering the GOT power supply off.)
- (2) Remove the battery folder from the GOT backside.

For other than GT155□

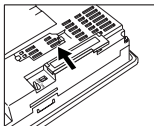

For GT155□

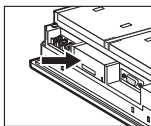

- (3) Remove the old battery from the folder and disconnect the connector.
- (4) Connect the new battery to the connector.
- (5) Insert the battery into the folder and set it into the GOT backside.
- (6) Turn the GOT power supply on.
- (7) Check if the battery condition is normal within the utility.
For details, refer to the GT15 User's Manual.

POINT

1. Precautions after battery replacement
Make sure to turn on the GOT power supply once upon completion of battery replacement.
Failure to do so may decrease the battery life.
2. When the 2- slot type extension unit is connected to GT156□
Before installing or replacing the battery, disconnect the unit.
(When connecting or disconnecting the unit, be sure to power off the GOT and PLC.)

7.3.4 Battery life

Life span of the battery set in the GOT is shown below.

Battery life		
Operating ambient temperature of 0 to 45°C	Operating ambient temperature of 45 to 55°C	Data backup time after detection of battery voltage low*
5 years	3 years	14 days

*: In the following conditions, the data backup time is 5 minutes after the power supply is turned off.

- The battery connector is disconnected.
- The battery lead is disconnected.

POINT

Battery life and replacement time

1. Battery life reference: Approx.5 years in actual use (ambient temperature of 25°C)
Battery replacement time reference: 4 to 5 years
Calculate the natural discharge amount of the battery, as necessary.
2. Check if the battery condition is normal within the utility.
For details, refer to the GT15 User's Manual.

Appendix Confirming of Versions and Conformed Standards

(1) Ratings plate

The GOT hardware version, function version, and the standards conformed by a GOT can be confirmed at the rating plate on the GOT rear face.

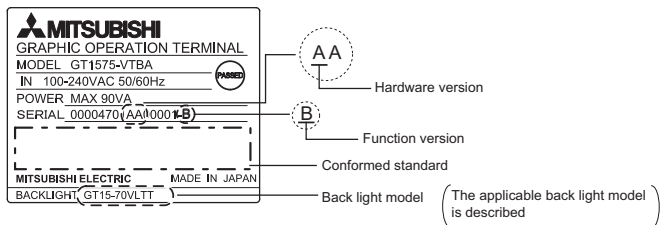

(2) Packing box

The standards conformed by a GOT can be confirmed by the label on the packing box.

Note that the position of the label differs depending on the model or shipment date.

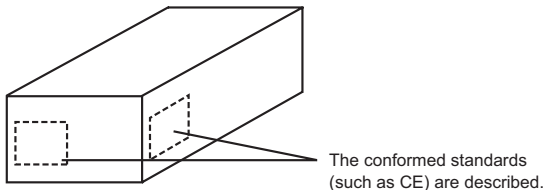

Warranty

Mitsubishi will not be held liable for damage caused by factors found not to be the cause of Mitsubishi; machine damage or lost profits caused by faults in the Mitsubishi products; damage, secondary damage, accident compensation caused by special factors unpredictable by Mitsubishi; damages to products other than Mitsubishi products; and to other duties.

For safe use

- This product has been manufactured as a general-purpose part for general industries, and has not been designed or manufactured to be incorporated in a device or system used in purposes related to human life.
- Before using the product for special purposes such as nuclear power, electric power, aerospace, medicine or passenger movement vehicles, consult with Mitsubishi.
- This product has been manufactured under strict quality control. However, when installing the product where major accidents or losses could occur if the product fails, install appropriate backup or failsafe functions in the system.

Country/Region Sales office/Tel

U.S.A	Mitsubishi Electric Automation Inc. 500 Corporate Woods Parkway Vernon Hills, IL 60061, U.S.A. Tel : +1-847-478-2100
Brazil	MELCO-TEC Rep. Com.e Assessoria Tecnica Ltda. Rua Correia Dias, 184, Edificio Paraiso Trade Center-8 andar Paraiso, Sao Paulo, SP Brazil Tel : +55-11-5908-8331
Germany	Mitsubishi Electric Europe B.V. German Branch Gothaer Strasse 8 D-40880 Ratingen, GERMANY Tel : +49-2102-486-0
U.K	Mitsubishi Electric Europe B.V. UK Branch Travellers Lane, Hatfield, Hertfordshire., AL10 8XB, U.K. Tel : +44-1707-276100
Italy	Mitsubishi Electric Europe B.V. Italian Branch Centro Dir. Colleoni, Pal. Perseo-Ingr.2 Via Paracelso 12, I-20041 Agrate Brianza, Milano, Italy Tel : +39-039-60531
Spain	Mitsubishi Electric Europe B.V. Spanish Branch Carretera de Rubi 76-80, E-08190 Sant Cugat del Valles, Barcelona, Spain Tel : +34-93-565-3131
France	Mitsubishi Electric Europe B.V. French Branch 25, Boulevard des Bouvets, F-92741 Nanterre Cedex, France TEL: +33-1-5568-5568
South Africa	Circuit Breaker Industries Ltd. Private Bag 2016, ZA-1600 Isando, South Africa Tel : +27-11-928-2000

Country/Region Sales office/Tel

Hong Kong	Mitsubishi Electric Automation (Hong Kong) Ltd. 10th Floor, Manulife Tower, 169 Electric Road, North Point, Hong Kong Tel : +852-2887-8870
China	Mitsubishi Electric Automation (Shanghai) Ltd. 4/F Zhi Fu Plaza, No.80 Xin Chang Road, Shanghai 200003, China Tel : +86-21-6120-0808
Taiwan	Setsuyo Enterprise Co., Ltd. 6F No.105 Wu-Kung 3rd.Rd, Wu-Ku Hsiang, Taipei Hsine, Taiwan Tel : +886-2-2299-2499
Korea	Mitsubishi Electric Automation Korea Co., Ltd. 1480-6, Gayang-dong, Gangseo-ku Seoul 157-200, Korea Tel : +82-2-3660-9552
Singapore	Mitsubishi Electric Asia Pte, Ltd. 307 Alexandra Road #05-01/02, Mitsubishi Electric Building, Singapore 159943 Tel : +65-6470-2460
Thailand	Mitsubishi Electric Automation (Thailand) Co., Ltd. Bang-Chan Industrial Estate No.111 Moo 4, Serithai Rd, T.Kannayao, A.Kannayao, Bangkok 10230 Thailand Tel : +66-2-517-1326
Indonesia	P.T. Autoteknindo Sumber Makmur Muara Karang Selatan, Block A/Utara No.1 Kav. No.11 Kawasan Industri Pergudangan Jakarta - Utara 14440, P.O.Box 5045 Jakarta, 11050 Indonesia Tel : +62-21-6630833
India	Messung Systems Pvt, Ltd. Electronic Sadan NO:III Unit No15, M.I.D.C Bhosari, Pune-411026, India Tel : +91-20-2712-3130
Australia	Mitsubishi Electric Australia Pty. Ltd. 348 Victoria Road, Rydalmere, N.S.W 2116, Australia Tel : +61-2-9684-7777

MITSUBISHI ELECTRIC CORPORATION

HEAD OFFICE : TOKYO BUILDING, 2-7-3 MARUNOUCHI, CHYODAI-KU, TOKYO 100-8310, JAPAN
NAGOYA WORKS : 1-14, YADA-MINAMI 5-CHOME, HIGASHI-KU, NAGOYA, JAPAN

When exported from Japan, this manual does not require application to the Ministry of Economy, Trade and Industry for service transaction permission.

Specifications subject to change without notice.
Printed in Japan.