

**NV Series**  
**NV3W(-V1)**  
**NV4W**  
**NV3Q**

# **Programmable Terminals**

## **HOST CONNECTION MANUAL**

**OMRON**

## **NOTE**

All rights reserved. No part of this publication may be reproduced, stored in a retrieval system, or transmitted, in any form, or by any means, mechanical, electronic, photocopying, recording, or otherwise, without the prior written permission of OMRON.

No patent liability is assumed with respect to the use of the information contained herein. Moreover, because OMRON is constantly striving to improve its high-quality products, the information contained in this manual is subject to change without notice. Every precaution has been taken in the preparation of this manual. Nevertheless, OMRON assumes no responsibility for errors or omissions. Neither is any liability assumed for damages resulting from the use of the information contained in this publication.

## **Trademarks**

- Microsoft, Windows, Windows Vista, Excel, and Visual Basic are either registered trademarks or trademarks of Microsoft Corporation in the United States and other countries.

Other company names and product names in this document are the trademarks or registered trademarks of their respective companies.

## **Copyrights**

Microsoft product screen shots reprinted with permission from Microsoft Corporation.

**NV Series**

**NV3W(-V1)**

**NV4W**

**NV3Q**

**Programmable Terminals**

*Produced May 2015*





# Notice

---

OMRON products are manufactured for use according to proper procedures by a qualified operator and only for the purposes described in this manual.

The following conventions are used to indicate and classify precautions in this manual. Always heed the information provided with them. Failure to heed precautions can result in injury to people or damage to property.

-  **DANGER** Indicates an imminently hazardous situation which, if not avoided, will result in death or serious injury. Additionally, there may be severe property damage.
-  **WARNING** Indicates a potentially hazardous situation which, if not avoided, could result in death or serious injury. Additionally, there may be severe property damage.
-  **Caution** Indicates a potentially hazardous situation which, if not avoided, may result in minor or moderate injury, or property damage.

## OMRON Product References

All OMRON products are capitalized in this manual. The word “Unit” is also capitalized when it refers to an OMRON product, regardless of whether or not it appears in the proper name of the product.

The abbreviation “Ch,” which appears in some displays and on some OMRON products, often means “word” and is abbreviated “Wd” in documentation in this sense.

The abbreviation “PLC” means Programmable Controller.

The abbreviation “host” means a controller, such as an IBM PC/AT or compatible computer, that controls a PT (Programmable Terminal).

## Visual Aids

The following headings appear in the left column of the manual to help you locate different types of information.

---

<b>Precautions for Safe Use</b>	Indicates precautions on handling the product to ensure that the product is used safely.
<b>Precautions for Correct Use</b>	Indicates precautions to ensure that product functions and performances are realized, to ensure that the reliability of the product is maintained, and to ensure that the product is otherwise used correctly.
<b>Note</b>	Indicates information of particular interest for efficient and convenient operation of the product.
<b>Reference</b>	Indicates supplementary information on procedures, descriptions, and settings.
<b>1,2,3...</b>	1. Indicates lists of one sort or another, such as procedures, checklists, etc.
CS1G-CPU□□-V1	Boxes in model numbers indicate variable characters. For example, “CS1G-CPU□□-EV1” indicates the following models: CS1G-CPU42-EV1, CS1G-CPU43-EV1, CS1G-CPU44-EV1, and CS1G-CPU45-EV1.

---



# TABLE OF CONTENTS

## SECTION 1

<b>Connecting to Mitsubishi Electric PLCs .....</b>	<b>1</b>
1-1 MELSEC-FX0N/FX1S/FX1N Series .....	2
1-2 MELSEC-FX2N/FX3U/FX3UC Series .....	4
1-3 MELSEC-Q Series (Serial Communications) .....	6
1-4 MELSEC-Q (CPU) Series .....	9
1-5 MELSEC-A Series (Computer Link) .....	11

## SECTION 2

<b>Connecting to Panasonic Electric Works PLCs.....</b>	<b>13</b>
2-1 FP-X Series .....	14
2-2 FP $\Sigma$ Series .....	18
2-3 FP0/FP0R Series .....	22
2-4 FP-e Series .....	25
2-5 MEWNET FP2/FP2SH Series .....	28
2-6 FP2 Computer Communications Unit (CCU) .....	31
2-7 FP7 Series .....	33

## SECTION 3

<b>Connecting to Toshiba Machine PLCs .....</b>	<b>45</b>
3-1 PROVISER TCmini Series .....	46

## SECTION 4

<b>Connecting to Allen-Bradley PLCs.....</b>	<b>49</b>
4-1 SLC500 Micro Logix Series .....	50

## SECTION 5

<b>Connecting to Siemens PLCs.....</b>	<b>53</b>
5-1 S7-200 Series .....	54

## SECTION 6

<b>Connecting to LG PLCs.....</b>	<b>57</b>
6-1 MASKER-K (Cnet) Series .....	58

## SECTION 7

<b>Connecting to Yokogawa PLCs.....</b>	<b>61</b>
7-1 FA-M3 Series .....	62

# TABLE OF CONTENTS

## SECTION 8

<b>Connecting to Keyence PLCs</b> .....	<b>65</b>
8-1 KV-10/16/24/40 Series .....	66
8-2 KV-700 Series .....	68
8-3 Connecting through a KV-L20R/V (KV-700-series Unit) .....	70
8-4 KV-1000 Series .....	72
8-5 Connecting through a KV-L20R/V (KV-1000-series Unit) .....	74
8-6 KV-3000 Series .....	76
8-7 Connecting through a KV-L20R/V (KV-3000/5000-series Unit) .....	78
8-8 KV Nano Series .....	81
8-9 Connecting through a KV-N10L (KV Nano-series Unit) .....	84

## SECTION 9

<b>Connecting to Hitachi PLCs</b> .....	<b>87</b>
9-1 EH-150/EHV Series .....	88
9-2 MICRO-EH Series .....	96
9-3 Web Controller Series .....	99

## SECTION 10

<b>Connecting in Modbus-RTU Mode: Master</b> .....	<b>105</b>
10-1 Modbus (RTU Mode, Modicon PLC) .....	106
10-2 Modbus (RTU Mode) .....	108
10-3 Modbus (RTU Mode   Temperature Controller) .....	111

## SECTION 11

<b>Connecting in Modbus-RTU Mode: Slave</b> .....	<b>115</b>
11-1 Modbus Slave (RTU Mode) .....	116

## SECTION 12

<b>Error Codes for Companies Other Than OMRON</b> .....	<b>111</b>
12-1 Error Codes .....	112
12-2 Mitsubishi Electric FX-series PLC Connections .....	113
12-3 Panasonic Electric Works FP-series PLC Connections .....	114
12-4 Toshiba Machine PLC Connections .....	116
12-5 Modbus Connections .....	117

<b>Revision History</b> .....	<b>119</b>
-------------------------------	------------



## Related Manuals

---

The following manuals are used for NV-series PTs. (The boxes at the end of the catalog numbers indicate the revision code.)

**This  
Manual**

NV-series PT Host Connection Manual ..... V105-E1-□

This manual describes how to connect an NV-series PT to a PLC produced by a manufacturer other than OMRON, including PLC memory area designations, communications settings, and connection methods.

NV-series PT Setup Manual ..... V103-E1-□

This manual describes how to connect an NV-series PT to an OMRON PLC, features and specifications, methods to set up communications and operation, and procedures for maintenance and troubleshooting.

Refer to the *NV-series PT Programming Manual* (V104-E1-□) for more information on PT functions and specific operating procedures.

NV-series PT Programming Manual ..... V104-E1-□

This manual describes the software functionality of NV-series PTs, how to install the NV-Designer, and the features of the NV-Designer.

For more information on NV-Designer operating procedures, refer to the online help in the NV-Designer.

# Introduction

---

## ● Intended Audience

This manual is intended for the following personnel, who must also have knowledge of electrical systems (an electrical engineer or the equivalent).

- Personnel in charge of introducing FA systems into production facilities.
- Personnel in charge of designing FA systems.
- Personnel in charge of installing and connecting FA systems.
- Personnel in charge of managing FA systems and facilities.

## ● General Precautions

- The user must operate the product according to the performance specifications described in the operation manuals.
- Do not use the PT touch switch input functions for applications where danger to human life or serious property damage is possible, or for emergency switch applications.
- Before using the product under conditions which are not described in the manual or applying the product to nuclear control systems, railroad systems, aviation systems, vehicles, combustion systems, medical equipment, amusement machines, safety equipment, and other systems, machines and equipment that may have a serious influence on lives and property if used improperly, consult your OMRON representative.
- Make sure that the ratings and performance characteristics of the product are sufficient for the systems, machines, and equipment, and be sure to provide the systems, machines, and equipment with double safety mechanisms.
- This manual provides information for connecting and setting up an NV-series PT. Be sure to read this manual before attempting to use the PT and keep this manual close at hand for reference during installation and operation.

# Safety Precautions

## Notation Used for Safety Information

The following notation is used in this manual to provide precautions required to ensure safe usage of the product.

The safety precautions that are provided are extremely important to safety.



Always read and heed the information provided in all safety precautions.







The following notation is used.

## Definition of Precautionary Information

 <b>WARNING</b>	Indicates a potentially hazardous situation which, if not avoided, will result in minor or moderate injury, or may result in serious injury or death. Additionally there may be significant property damage.
--	--

## Symbols

	<b>Prohibition</b> Indicates a general prohibition.
	<b>Caution</b> Indicates general cautionary, warning, or danger level information.

 <b>WARNING</b>	
Always ensure that the personnel in charge confirm that installation, inspection, and maintenance were properly performed for the PT. "Personnel in charge" refers to individuals qualified and responsible for ensuring safety during machine design, installation, operation, maintenance, and disposal.	
Ensure that installation and post-installation checks are performed by personnel in charge who possess a thorough understanding of the machinery to be installed.	
Do not use the input functions of the PT, such as the function switches or switches on the touch panel, in applications that involve human life, in applications that may result in serious injury, or for emergency stop switches.	
Do not attempt to disassemble, repair, or modify the PT. Doing so may impair the safety functions.	
Do not attempt to take the Unit apart and do not touch any internal parts while the power is being supplied. Doing either of these may result in electrical shock.	
The PT uses an analog touch panel. Never press more than two points on the panel at a time. Otherwise, it may activate a switch somewhere between the two points.	

# Precautions for Safe Use

1. When unpacking the Units, check carefully for any external scratches or other damage. Also, shake the Units gently and check for any abnormal sound.
2. The PT must be installed in a control panel.
3. The mounting panel must be between 1.6 and 4.8 mm thick. Tighten the Mounting Brackets evenly to a torque of between 0.1 and 0.25 N·m for the NV3W/NV3Q and between 0.2 and 0.3 N·m for the NV3W-V1/NV4W to maintain water and dust resistance. Make sure the panel is not dirty or warped and that it is strong enough to hold the Units.
4. Do not let metal particles enter the Units when preparing the panel.
5. Do not connect an AC power supply to the DC power terminals.
6. Do not perform a dielectric voltage test.
7. Use a DC power supply that will provide a stable output even if the input is momentarily interrupted for 10 ms, and which has reinforced or double insulation.

Model	Rated power supply voltage	Capacity
NV3W-M□20L-V1 NV3W-M□20L	5 VDC (allowable range: 4.5 to 5.5 VDC)	1 W min.
NV4W-M□□□	24 VDC (allowable range: 21.6 to 26.4 VDC)	1.7 W min.
NV3W-M□20-V1 NV3W-M□40-V1		1.9 W min.
NV3W-M□□□		2 W min.
NV3Q-MR□□		2.4 W min.
NV3Q-SW□□		3.6 W min.

8. Use a twisted-pair cable to connect to the power terminals. Tighten the terminal screws to a torque of between 0.22 and 0.30 N·m. Make sure the screws are properly tightened.
9. To prevent malfunctions caused by noise, ground the PT correctly.
10. Do not touch the surface of the circuit boards or the components mounted on them with your bare hands. Discharge any static electricity from your body before handling the boards.
11. Turn OFF the power supply before connecting or disconnecting cables.
12. The maximum tensile load for cables is 30 N. Do not apply loads greater than this.
13. Confirm the safety of the system before turning ON or OFF the power supply.
14. Cycle the power supply after changing the DIP switch settings.
15. Do not perform the following operations while the SD memory card is being accessed (NV4W/NV3Q only):
  - Turning OFF the power supply to the PT
  - Removing the memory card
 Always follow the specified procedure when removing the memory card.
16. Start actual system application only after sufficiently checking screen data and the operation of the program in the PLC (host).
17. Do not press the touch switch with a force greater than 30 N.
18. Do not use a screwdriver or any other tool to press a touch switch.
19. Confirm the safety of the system before pressing any touch switch.
20. Do not accidentally press touch switches when the backlight is not lit or when the display does not appear. Confirm the safety of the system before pressing touch switches.
21. Before initializing screen data, confirm that existing data is backed up at the NV-Designer.

22. When changing the password with the system menu, do not reset or turn OFF the power supply until writing is finished.
23. Before using the SPMA function to change memory values in the PLC or transfer ladder programming, confirm that the PT is operating. The SPMA function cannot be used unless the PT is operating.
24. Dispose of any battery that has been dropped on the floor or otherwise subjected to excessive shock.
25. Dispose of the Units and batteries according to local ordinances as they apply.



廢電池請回收

26. When mounting the Battery, be sure to use the correct Battery and mount it correctly.
27. Do not disassemble or short-circuit the battery.
28. Do not connect a USB connector to any device that is not applicable.
29. Before connecting a USB connector to a device, make sure that the device is free of damage.
30. Do not turn OFF the power supply to the PT while downloading or uploading screen data or the system program. Doing so may corrupt the screen data or system program.
31. Periodically inspect the installation condition of the PT if it is being used in an environment subject to contact with water.
32. The whole system may stop depending on how the power supply is turned ON or OFF. Turn ON or OFF the power supply according to the specified procedure.
33. Signals from the touch switches may not be input if the switches are pressed consecutively at high speed. Confirm each input before proceeding to the next one.
34. To use numeric input functions safely, always make maximum and minimum limit settings.
35. Do not use benzene, paint thinner, or other volatile solvents, and do not use chemically treated cloths.
36. The PT uses an analog touch panel. Deterioration over time can cause the touch points to move. Calibrate the touch panel if the touch points move too much.
37. Water resistance will be lost if the front sheet is torn or is peeling off. Do not use the PT if the front sheet is torn or is peeling off.
38. The Rubber Packing will deteriorate, shrink, or harden depending on the operating environment. Inspect and replace the Rubber Packing periodically (approximately once per year).
39. To use the NV3W in an environment with strong noise, connect the following noise filter to the power supply line: RSEL-2001W manufactured by TDK-Lambda Corp.
40. A Waterproof Packing cannot be reused. To ensure waterproof performance, replace the Waterproof Packing with a new one each time you reinstall the PT.
41. Screen burn-in will occur if the same pattern is continuously displayed for a long period of time (24 hours or longer, as a guideline). To prevent screen burn-in, use a screen saver or switch displays periodically (NV3W only).

## Precautions for Correct Use

---

1. Do not install the PT in any of the following locations.
  - Locations subject to rapid changes in temperature
  - Locations subject to temperatures or humidity outside the range specified in the specifications
  - Locations subject to condensation as the result of high humidity
  - Locations subject to splashing chemicals or solvents
  - Locations subject to oil splashes
  - Locations subject to continuous water splashing
  - Locations subject to corrosive or flammable gases
  - Locations subject to strong shock or vibration
  - Locations outdoors subject to direct wind and rain
  - Locations subject to strong ultraviolet light
  - Locations subject to dust
  - Locations subject to direct sunlight
2. Take appropriate and sufficient countermeasures when installing systems in the following locations.
  - Locations subject to static electricity or other forms of noise
  - Locations subject to strong electromagnetic or magnetic fields
  - Locations close to power supply lines
  - Locations subject to possible exposure to radioactivity

## Conformance to EC Directives

---

This product is EMC compliant.

### ● Concepts

OMRON products are electronic devices that are incorporated in machines and manufacturing installations. OMRON PTs conform to the related EMC Directives (see note) so that the devices and machines into which they are built can more easily conform to EMC directives. However, customers may use a wide variety of equipment and manufacturing installations. Therefore the customer must check whether the Directives are satisfied for the actual system. EMC-related performance will vary depending on the configuration, wiring, and other conditions of the equipment or control panel in which the PT is installed. The customer must, therefore, perform final checks to confirm that the overall machine or device conforms to EMC standards.

**Note** The applicable EMC (Electromagnetic Compatibility) standards for NV-series PTs are as follows:  
NV3W: EN 61000-6-2, EN 61000-6-4  
NV3W-V1/NV4W/NV3Q: EN 61131-2

### ● Conformance to EC Directives

NV-series PTs conform to EC Directives. To ensure that the machine or device in which the NV-series PT is used complies with EC Directives, the PT must be installed as follows:

- The NV-series PT must be installed in a control panel.
- You must use reinforced insulation or double insulation for the DC power supply and the DC power supply must have minimal voltage fluctuations and provide a stable output even if the power supply input is interrupted for 10 ms.
- NV-series PTs complying with EC Directives also conform to the Common Emission Standard (EN 61131-2 or EN 61000-6-4). Radiated emission characteristics (10-m regulations) may vary depending on the configuration of the control panel used, other devices connected to the control panel, wiring, and other conditions. You must therefore confirm that the overall machine or equipment complies with EC Directives.
- This is a class A product. It may cause radio interference in residential areas, in which case the user may be required to take adequate measures to reduce interference.

## Conformance to KC Standards

---

Observe the following precaution if you use NA-series PTs in Korea.

A 급 기기 (업무용 방송통신기자재)  
이 기기는 업무용(A 급) 전자파적합기기로서  
또는 사용자는 이 점을 주의하시기 바라며,  
지역에서 사용하는 것을 목적으로 합니다.

Class A Device (Broadcasting Communications Device for Business Use)

This device obtained EMC registration for office use (Class A), and it is intended to be used in places other than homes. Sellers and/or users need to take note of this.





# ***Terms and Conditions Agreement***

## ***Warranty, Limitations of Liability***

### **Warranties**

#### **● Exclusive Warranty**

Omron's exclusive warranty is that the Products will be free from defects in materials and workmanship for a period of twelve months from the date of sale by Omron (or such other period expressed in writing by Omron). Omron disclaims all other warranties, express or implied.

#### **● Limitations**

OMRON MAKES NO WARRANTY OR REPRESENTATION, EXPRESS OR IMPLIED, ABOUT NON-INFRINGEMENT, MERCHANTABILITY OR FITNESS FOR A PARTICULAR PURPOSE OF THE PRODUCTS. BUYER ACKNOWLEDGES THAT IT ALONE HAS DETERMINED THAT THE PRODUCTS WILL SUITABLY MEET THE REQUIREMENTS OF THEIR INTENDED USE.

Omron further disclaims all warranties and responsibility of any type for claims or expenses based on infringement by the Products or otherwise of any intellectual property right.

#### **● Buyer Remedy**

Omron's sole obligation hereunder shall be, at Omron's election, to (i) replace (in the form originally shipped with Buyer responsible for labor charges for removal or replacement thereof) the non-complying Product, (ii) repair the non-complying Product, or (iii) repay or credit Buyer an amount equal to the purchase price of the non-complying Product; provided that in no event shall Omron be responsible for warranty, repair, indemnity or any other claims or expenses regarding the Products unless Omron's analysis confirms that the Products were properly handled, stored, installed and maintained and not subject to contamination, abuse, misuse or inappropriate modification. Return of any Products by Buyer must be approved in writing by Omron before shipment. Omron Companies shall not be liable for the suitability or unsuitability or the results from the use of Products in combination with any electrical or electronic components, circuits, system assemblies or any other materials or substances or environments. Any advice, recommendations or information given orally or in writing, are not to be construed as an amendment or addition to the above warranty.

See <http://www.omron.com/global/> or contact your Omron representative for published information.

### **Limitation on Liability; Etc**

OMRON COMPANIES SHALL NOT BE LIABLE FOR SPECIAL, INDIRECT, INCIDENTAL, OR CONSEQUENTIAL DAMAGES, LOSS OF PROFITS OR PRODUCTION OR COMMERCIAL LOSS IN ANY WAY CONNECTED WITH THE PRODUCTS, WHETHER SUCH CLAIM IS BASED IN CONTRACT, WARRANTY, NEGLIGENCE OR STRICT LIABILITY.

Further, in no event shall liability of Omron Companies exceed the individual price of the Product on which liability is asserted.

# ***Application Considerations***

## **Suitability of Use**

Omron Companies shall not be responsible for conformity with any standards, codes or regulations which apply to the combination of the Product in the Buyer's application or use of the Product. At Buyer's request, Omron will provide applicable third party certification documents identifying ratings and limitations of use which apply to the Product. This information by itself is not sufficient for a complete determination of the suitability of the Product in combination with the end product, machine, system, or other application or use. Buyer shall be solely responsible for determining appropriateness of the particular Product with respect to Buyer's application, product or system. Buyer shall take application responsibility in all cases.

NEVER USE THE PRODUCT FOR AN APPLICATION INVOLVING SERIOUS RISK TO LIFE OR PROPERTY WITHOUT ENSURING THAT THE SYSTEM AS A WHOLE HAS BEEN DESIGNED TO ADDRESS THE RISKS, AND THAT THE OMRON PRODUCT(S) IS PROPERLY RATED AND INSTALLED FOR THE INTENDED USE WITHIN THE OVERALL EQUIPMENT OR SYSTEM.

## **Programmable Products**

Omron Companies shall not be responsible for the user's programming of a programmable Product, or any consequence thereof.

## ***Disclaimers***

### **Performance Data**

Data presented in Omron Company websites, catalogs and other materials is provided as a guide for the user in determining suitability and does not constitute a warranty. It may represent the result of Omron's test conditions, and the user must correlate it to actual application requirements. Actual performance is subject to the Omron's Warranty and Limitations of Liability.

### **Change in Specifications**

Product specifications and accessories may be changed at any time based on improvements and other reasons. It is our practice to change part numbers when published ratings or features are changed, or when significant construction changes are made. However, some specifications of the Product may be changed without any notice. When in doubt, special part numbers may be assigned to fix or establish key specifications for your application. Please consult with your Omron's representative at any time to confirm actual specifications of purchased Product.

### **Errors and Omissions**

Information presented by Omron Companies has been checked and is believed to be accurate; however, no responsibility is assumed for clerical, typographical or proofreading errors or omissions.

# Applicable PLCs

The PLCs that are supported are listed below.

This list includes all models for which operation has been appraised as of May 2015.

- : Direct connection is possible to the CPU Unit of the PLC.
- : A Communications Unit or a cable to convert signals is required to connect to these PLCs.

Blank: Not appraised.

Company	Series	Model	Communications method	
			RS-232C	RS-422A RS-485
OMRON	CP Series	CP1H	○	○
		CP1L <sup>*1</sup>	○	○
		CP1E-N (excluding CP1E-E)	●	○
	CJ Series	CJ2H-CPU□□H	●	○
		CJ2H-CPU□□H-EIP	●	○
		CJ2M-CPU□□	●	○
		CJ1H-CPU□□H-R	●	○
		CJ1H-CPU□□(H)	●	○
		CJ1G-CPU□□(H)	●	○
		CJ1G-CPU□□P	●	○
		CJ1M-CPU□□	●	○
	CS Series	CS1H-CPU□□(H)	●	○
		CS1G-CPU□□(H)	●	○
		CS1D-CPU□□(H)	●	○
	C Series	CPM1A	○	○
		CPM2A	●	○
		CPM2C	○	○
		CPM2C-S	○	○
		CQM1H-CPU21	●	○
		CQM1H-CPU51	●	○
		CQM1H-CPU61	●	○
		SRM1-C02-V2	●	○
		C200HE-CPU11(-Z)	○	○
		C200HE-CPU32(-Z)	○	○
		C200HE-CPU42(-Z)	●	○
		C200HG-CPU33(-Z)	○	○
		C200HG-CPU43(-Z)	●	○
		C200HG-CPU53(-Z)	○	○
	C200HG-CPU63(-Z)	●	○	
	OMRON	C Series	C200HX-CPU34(-Z)	○
C200HX-CPU44(-Z)			●	○
C200HX-CPU54(-Z)			○	○
C200HX-CPU64(-Z)			●	○
C200HX-CPU65-Z			●	○
C200HX-CPU85(-Z)			●	○
CVM1/CV Series		CV500	●	○
		CV1000	●	○
		CVM1	●	○
Temperature Controllers EJ1 Series		EJ1 <sup>*2</sup>		●

Refer to online help in the NV-Designer or the NV-series PT Setup Manual (Cat. No. V103) for information on connecting to OMRON PLCs.

\*1 Excluding the CP1L-L104D□-□.

\*2 Modbus communications are used.

- : Direct connection is possible to the CPU Unit of the PLC.
  - : A Communications Unit or a cable to convert signals is required to connect to these PLCs.
- Blank: Not appraised.

Company	Series	Model	Communications method	
			RS-232C	RS-422A RS-485
Mitsubishi Electric* <sup>1</sup>	FX Series	FX0N	○	●
		FX1S	○	●
		FX1N	○	●
		FX1NC	○	●
		FX2N	○	●
		FX2NC	○	●
		FX3UC	○	●
	Q Series	Q00CPU	●	
		Q01CPU	●	
		Q00JCPU	○	
		Q00HCPU	○	
		Q25HCPU	●	
		Q12HCPU	●	
		Q06HCPU	●	
		Q02HCPU	●	
	Q02CPU	●		
	A Series	A1N	○	
		A2N	○	
		A3N	○	
		A1S	○	
		A1SH	○	
A2CCPU24		●		
Panasonic Electric Works* <sup>1</sup>	FP Series	FP-X	●	○
		FP-Σ	●	○
		FP-e	●	○
		FP0/FP0R	●	○
		FP2	●	○
		FP2SH	●	○
		FP7	●	○

\*1 There may be restrictions in the device types and addresses that can be used for PLCs not manufactured by OMRON. Refer to the connection diagrams for details.

- : Direct connection is possible to the CPU Unit of the PLC.
- : A Communications Unit or a cable to convert signals is required to connect to these PLCs.

Blank: Not appraised.

Company	Series	Model	Communications method	
			RS-232C	RS-422A RS-485
Toshiba Machine* <sup>1</sup>	TC mini Series		● Models with RS-232C port	● Models with RS-422A port
Yokogawa Electric* <sup>1</sup>	FA-M3 Series	F3SP59-7S	●	
		F3SP58-6S	●	
		F3SP58-6H	●	
		F3SP53-4S	●	
		F3SP53-4H	●	
		F3SP38-6S	●	
		F3SP35-5N	●	
		F3SP28-3S	●	
		F3SP28-3N	●	
		F3SP25-2N	●	
		F3SP21-0N	●	
Keyence* <sup>1</sup>	KV Series	KV-10/16/24/40	●	
		KV700	●	○
		KV1000	●	○
		KV3000	●	○
		KV5000	○	○
		KV nano	●	
Hitachi* <sup>1</sup>	EH-150EHV Series	EHV-CPU128	●	●
		EHV-CPU64	●	●
		EHV-CPU32	●	●
		EHV-CPU16	●	●
	EH150 Series	EH-CPU104A	●	●
		EH-CPU208A	●	●
		EH-CPU316A	●	●
		EH-CPU516	●	●
		EH-CPU548	●	●
	MICRO-EH Series	10 points		
		14 points	●	
		20 points	●	
		23 points	●	●
		28 points	●	●
		40 points	●	
		64 points	●	
	Web Controller	10 points	●	
23 points		●	●	

\*1 There may be restrictions in the device types and addresses that can be used for PLCs not manufactured by OMRON. Refer to the connection diagrams for details.

- : Direct connection is possible to the CPU Unit of the PLC.
- : A Communications Unit or a cable to convert signals is required to connect to these PLCs.

Blank: Not appraised.

Company	Series	Model	Communications method	
			RS-232C	RS-422A RS-485
Allen-Bradley* <sup>1</sup> Models that support DF protocol	MicroLogix	MicroLogix 1000	●	
	SLC-500 Series	SLC-5/03	●	
		SLC-5/04	●	
Siemens* <sup>1</sup>	S7-200 Series	CPU222	○	●
		CPU216	○	●
		CPU215	○	●
		CPU214	○	●
		CPU212	○	●
LG* <sup>1</sup>	MASTER-K Series	80S	●	
		200S	●	
		300S	○	
		1000S	○	
Modbus* <sup>2</sup>	Models that support RTU protocol	*2	●	●

\*1 There may be restrictions in the device types and addresses that can be used for PLCs not manufactured by OMRON. Refer to the connection diagrams for details.

\*2 It is not possible to specify all PLC models that can be used. Test operation using the actual PLC.

## Connection Diagrams

The connection diagrams between PLCs and NV-series PTs are based on the NV3W(-V1) with 24-VDC input power. The connector on other NV-series PTs must be changed as described below for other models of NV-series PTs.

### NV3W with 5-VDC Input Power

Pin 3 changes from FG to NC. Do not connect anything to pin 3.

When connecting the PT to a non-OMRON PLC, use an external 5-VDC power supply. You must use an OMRON CS/CJ-series or CP-series PLC and an XW2Z-200T-4 Connecting Cable to connect the internal PLC power to the PT. Operation may not be correct if any other PLCs or cables are used.

### NV3W-V1/NV4W/NV3Q (RS-232C Models)

Pin 6 changes from NC to RS and pin 7 changes from NC to CS. (These pins are not actually used.)

# SECTION 1

## Connecting to Mitsubishi Electric PLCs

1-1	MELSEC-FX0N/FX1S/FX1N Series . . . . .	2
1-1-1	Connecting to the Tool Port . . . . .	3
1-1-2	Connecting through an Adapter . . . . .	3
1-2	MELSEC-FX2N/FX3U/FX3UC Series . . . . .	4
1-2-1	Connecting to the Tool Port . . . . .	5
1-2-2	Connecting through an Adapter . . . . .	5
1-3	MELSEC-Q Series (Serial Communications). . . . .	6
1-3-1	Connecting to the MELSEC-Q Series (Serial Communications). . .	8
1-3-2	Connecting to RS-232C Port on Q00 or Q01 CPU . . . . .	8
1-4	MELSEC-Q (CPU) Series . . . . .	9
1-4-1	Connecting to the MELSEC-Q (CPU) Series. . . . .	10
1-5	MELSEC-A Series (Computer Link) . . . . .	11
1-5-1	Connecting to the MELSEC-A Series (Computer Link Unit) . . . . .	12

# 1-1 MELSEC-FX0N/FX1S/FX1N Series

**PLC Model Selection**      Select Mitsubishi MELSEC-FX Series.

## Applicable Devices

Bit/word devices		No.	Comments
Bit devices	Input relays	X 0000 to X 0337	
	Output relays	Y 0000 to Y 0337	
	Auxiliary relays	M 0000 to M 1535	
	State relays	S 0000 to S 0999	
	Timer contacts	TS 0000 to TS 0255	
	Counter contacts	CS 0000 to CS 0255	
Word devices	Input relays	X 0000 to X 0320	The decimal equivalent of the address must be a multiple of 20.
	Output relays	Y 0000 to Y 0320	The decimal equivalent of the address must be a multiple of 20.
	Auxiliary relays	M 0000 to M 1520	The address must be a multiple of 16.
	State relays	S 0000 to S 0976	The address must be a multiple of 16.
	Timer current values	TN 0000 to TN 0255	
	16-bit counter current values	CN 0000 to CN 0199	
	32-bit counter current values	CN 0200 to CN 0255	
	Data registers	D 0000 to D 0999	

- Note**
- (1) The addressable memory ranges depend on the model of PLC that is used. Refer to the user manuals for your PLC for details.
  - (2) Word device addresses in the input relay, output relay, and auxiliary relay areas must be multiples of 16 when expressed in decimal form. (For example: X 000, X020, X040... or M 000, M 016, M 032)

**Communications Settings**      The following communications settings are recommended for the PT and PLC.

■ **PT Communications Settings (Set from the NV-Designer using the NV Configuration.)**

Item	Setting
Baud rate	9,600 bps
Data bits	7
Stop bits	1
Parity	Even

■ **PLC Communications Settings**

Set D8120 to 0. (The default value is 0, so normally nothing needs to be done.)



### 1-1-1 Connecting to the Tool Port

For RS-422A with 24-VDC Power

CPU	Interface	Connection diagram		PT																		
FX0N FX1S FX1N	Tool port on PLC	<table border="1"> <thead> <tr> <th>Pin No.</th> <th>Signal</th> </tr> </thead> <tbody> <tr><td>1</td><td>-RD</td></tr> <tr><td>2</td><td>+RD</td></tr> <tr><td>3</td><td>SG</td></tr> <tr><td>4</td><td>-SD</td></tr> <tr><td>5</td><td>+5V</td></tr> <tr><td>6</td><td>-</td></tr> <tr><td>7</td><td>+SD</td></tr> <tr><td>8</td><td>-</td></tr> </tbody> </table>	Pin No.	Signal	1	-RD	2	+RD	3	SG	4	-SD	5	+5V	6	-	7	+SD	8	-		NV3W(-V1), NV4W, or NV3Q for RS-422A with 24-VDC power
Pin No.	Signal																					
1	-RD																					
2	+RD																					
3	SG																					
4	-SD																					
5	+5V																					
6	-																					
7	+SD																					
8	-																					

### 1-1-2 Connecting through an Adapter

For RS-232C

CPU	Adapter	Connection diagram		PT																				
FX0N FX1S FX1N	FIN-232-B	<table border="1"> <thead> <tr> <th>Pin No.</th> <th>Signal</th> </tr> </thead> <tbody> <tr><td>1</td><td>CD</td></tr> <tr><td>2</td><td>RD</td></tr> <tr><td>3</td><td>SD</td></tr> <tr><td>4</td><td>ER</td></tr> <tr><td>5</td><td>SG</td></tr> <tr><td>6</td><td>DR</td></tr> <tr><td>7</td><td>-</td></tr> <tr><td>8</td><td>-</td></tr> <tr><td>9</td><td>-</td></tr> </tbody> </table>	Pin No.	Signal	1	CD	2	RD	3	SD	4	ER	5	SG	6	DR	7	-	8	-	9	-		NV3W(-V1), NV4W, or NV3Q for RS-232C with 24-VDC power
Pin No.	Signal																							
1	CD																							
2	RD																							
3	SD																							
4	ER																							
5	SG																							
6	DR																							
7	-																							
8	-																							
9	-																							

**Note** The NV3W model for RS-422A cannot communicate with an FX-series PLC through an RS-422A or RS-485 Adapter.

# 1-2 MELSEC-FX2N/FX3U/FX3UC Series

**PLC Model Selection**      Select Mitsubishi MELSEC-FX2N Series.

## Applicable Devices

Bit/word devices		No.	Comments
Bit devices	Input relays	X 0000 to X 0337	
	Output relays	Y 0000 to Y 0337	
	Auxiliary relays	M 0000 to M 3071	
	State relays	S 0000 to S 0999	
	Timer contacts	TS 0000 to TS 0255	
	Counter contacts	CS 0000 to CS 0255	
Word devices	Input relays	X 0000 to X 0320	The decimal equivalent of the address must be a multiple of 20.
	Output relays	Y 0000 to Y 0320	The decimal equivalent of the address must be a multiple of 20.
	Auxiliary relays	M 0000 to M 3056	The address must be a multiple of 16.
	State relays	S 0000 to S 0976	The address must be a multiple of 16.
	Timer current values	TN 0000 to TN 0255	
	16-bit counter current values	CN 0000 to CN 0199	
	32-bit counter current values	CN 0200 to CN 0255	
	Data registers	D 0000 to D 7999	

- Note**
- (1) The addressable memory ranges depend on the model of PLC that is used. Refer to the user manuals for your PLC for details.
  - (2) Word device addresses in the input relay, output relay, and auxiliary relay areas must be multiples of 16 when expressed in decimal form. (For example: X 000, X020, X040... or M 000, M 016, M 032)

**Communications Settings**      The following communications settings are recommended for the PT and PLC.

■ **PT Communications Settings (Set from the NV-Designer using the NV Configuration.)**

Item	Setting
Baud rate	9,600 bps
Data bits	7
Stop bits	1
Parity	Even

■ **PLC Communications Settings**

Set D8120 to 0.

### 1-2-1 Connecting to the Tool Port

For RS-422A

CPU	Interface	Connection diagram		PT																																							
FX2N FX3U FX3UC	Tool port on PLC	<table border="1"> <thead> <tr> <th colspan="2">Mitsubishi PLC tool port</th> </tr> <tr> <th>Pin No.</th> <th>Signal</th> </tr> </thead> <tbody> <tr><td>1</td><td>-RD</td></tr> <tr><td>2</td><td>+RD</td></tr> <tr><td>3</td><td>SG</td></tr> <tr><td>4</td><td>-SD</td></tr> <tr><td>5</td><td>+5V</td></tr> <tr><td>6</td><td>-</td></tr> <tr><td>7</td><td>+SD</td></tr> <tr><td>8</td><td>-</td></tr> </tbody> </table>	Mitsubishi PLC tool port		Pin No.	Signal	1	-RD	2	+RD	3	SG	4	-SD	5	+5V	6	-	7	+SD	8	-		<table border="1"> <thead> <tr> <th>Pin No.</th> <th>Signal</th> </tr> </thead> <tbody> <tr><td>1</td><td>+</td></tr> <tr><td>2</td><td>-</td></tr> <tr><td>3</td><td>FG</td></tr> <tr><td>4</td><td>+SD</td></tr> <tr><td>5</td><td>-SD</td></tr> <tr><td>6</td><td>+RD</td></tr> <tr><td>7</td><td>-RD</td></tr> <tr><td>8</td><td>Terminator setting (built-in 120 Ω resistance)</td></tr> </tbody> </table>	Pin No.	Signal	1	+	2	-	3	FG	4	+SD	5	-SD	6	+RD	7	-RD	8	Terminator setting (built-in 120 Ω resistance)	NV3W(-V1), NV4W, or NV3Q for RS-422A with 24-VDC power
Mitsubishi PLC tool port																																											
Pin No.	Signal																																										
1	-RD																																										
2	+RD																																										
3	SG																																										
4	-SD																																										
5	+5V																																										
6	-																																										
7	+SD																																										
8	-																																										
Pin No.	Signal																																										
1	+																																										
2	-																																										
3	FG																																										
4	+SD																																										
5	-SD																																										
6	+RD																																										
7	-RD																																										
8	Terminator setting (built-in 120 Ω resistance)																																										

### 1-2-2 Connecting through an Adapter

For RS-232C

CPU	Adapter	Connection diagram		PT																																									
FX2N	FIN-232-BD	<table border="1"> <thead> <tr> <th colspan="2">Mitsubishi PLC Adapter</th> </tr> <tr> <th>Pin No.</th> <th>Signal</th> </tr> </thead> <tbody> <tr><td>1</td><td>CD</td></tr> <tr><td>2</td><td>RD</td></tr> <tr><td>3</td><td>SD</td></tr> <tr><td>4</td><td>ER</td></tr> <tr><td>5</td><td>SG</td></tr> <tr><td>6</td><td>DR</td></tr> <tr><td>7</td><td>-</td></tr> <tr><td>8</td><td>-</td></tr> <tr><td>9</td><td>-</td></tr> </tbody> </table>	Mitsubishi PLC Adapter		Pin No.	Signal	1	CD	2	RD	3	SD	4	ER	5	SG	6	DR	7	-	8	-	9	-		<table border="1"> <thead> <tr> <th>Pin No.</th> <th>Signal</th> </tr> </thead> <tbody> <tr><td>1</td><td>+</td></tr> <tr><td>2</td><td>-</td></tr> <tr><td>3</td><td>FG</td></tr> <tr><td>4</td><td>SD</td></tr> <tr><td>5</td><td>RD</td></tr> <tr><td>6</td><td>NC</td></tr> <tr><td>7</td><td>NC</td></tr> <tr><td>8</td><td>SG</td></tr> </tbody> </table>	Pin No.	Signal	1	+	2	-	3	FG	4	SD	5	RD	6	NC	7	NC	8	SG	NV3W(-V1), NV4W, or NV3Q for RS-232C with 24-VDC power
Mitsubishi PLC Adapter																																													
Pin No.	Signal																																												
1	CD																																												
2	RD																																												
3	SD																																												
4	ER																																												
5	SG																																												
6	DR																																												
7	-																																												
8	-																																												
9	-																																												
Pin No.	Signal																																												
1	+																																												
2	-																																												
3	FG																																												
4	SD																																												
5	RD																																												
6	NC																																												
7	NC																																												
8	SG																																												

**Note** The NV3W model for RS-422A cannot communicate with an FX-series PLC through an RS-422A or RS-485 Adapter.

## 1-3 MELSEC-Q Series (Serial Communications)

### PLC Model Selection

Select Mitsubishi MELSEC-Q (Serial Communication) Series.

Select Mitsubishi MELSEC-Q (Serial Communication) Series even when connected directly to the RS-232C port on the Q00 or Q01 CPU.

### Applicable Devices

	Bit/word devices	No.	Comments
Bit devices	Input relays	X 000000 to X 001FFF	
	Output relays	Y 000000 to Y 001FFF	
	Auxiliary relays	M 000000 to M 032767	
	Latched relays	L 000000 to L 032767	
	Annunciators	F 000000 to F 032767	
	Edge relays	V 000000 to V 032767	
	Link relays	B 000000 to B 007FFF	
	Special relays	SM 000000 to SM 002047	
	Link special relays	SB 000000 to SB 0007FF	
	Step relays	S 000000 to S 008191	
	Direct inputs	DX 000000 to DX 001FFF	
	Direct outputs	DY 000000 to DY 001FFFF	
	Timer contacts	TS 000000 to TS 023087	
	Timer coils	TC 000000 to TC 023087	
	Accumulative timer contacts	SS 000000 to SS 023087	
	Accumulative timer coils	SC 000000 to SC 023087	
	Counter contacts	CS 000000 to CS 023087	
Counter coils	CC 000000 to CC 023087		
Word devices	Input relays	X 000000 to X 001FF0	The first digit of the address must be 0.
	Output relays	Y 000000 to Y 001FF0	The first digit of the address must be 0.
	Auxiliary relays	M 000000 to M 032752	The address must be a multiple of 16.
	Latched relays	L 000000 to L 032752	
	Annunciators	F 000000 to F 032752	
	Edge relays	V 000000 to V 032752	
	Link relays	B 000000 to B 007FF0	The first digit of the address must be 0.
	Special relays	SM 000000 to SM 002032	
	Link special relays	SB 000000 to SB 0007F0	
	Step relays	S 000000 to S 008176	
	Direct inputs	DX 000000 to DX 001FF0	
	Direct outputs	DY 000000 to DY 001FF0	
	Timer current values	TN 000000 to TN 023087	
	Accumulative timer current values	SN 000000 to SN 023087	
	Counter current values	CN 000000 to CN 023087	
	Data registers	D 000000 to D 025983	
	Link registers	W 000000 to W 00657F	
	Link special registers	SW 000000 to SW 0007FF	
	File registers (for normal access)	R 000000 to R 032767	
File registers (for serial access)	ZR 000000 to ZR 0FE7FF		
Special registers	SD 000000 to SD 002047		

### Note

- (1) The maximum values that can be set by the PT are given.
- (2) The addressable memory ranges depend on the model of PLC that is used. Refer to the user manuals for your PLC for details.

- (3) When using serial communications, do not use the number of points set for X and Y from the addresses specified for the first allocated I/O (X and Y).
- (4) Mitsubishi MELSEC-A (Computer Link) Series setting can also be used, but if it is, the address ranges will be the same as for the Mitsubishi MELSEC-A (Computer Link) Series.

**Communications Settings** The following communications settings are recommended for the PT and PLC.

**■ PT Communications Settings (Set from the NV-Designer using the NV Configuration.)**

Item	Setting
PLC station number	0
Baud rate	19,200 bps
Data bits	8
Stop bits	1
Parity	Odd
Checksum	Enabled

**Note** The NV-series PTs support QnA-compatible 4C frame type 4.

**■ PLC Communications Settings**

Item	Setting
Station number	0
Baud rate	19,200 bps
Data bits	8
Stop bits	1
Parity	Odd
Checksum	Enabled
Interface	RS-232C
Communications protocol	Type 4
Write setting during RUN	Allowed

### 1-3-1 Connecting to the MELSEC-Q Series (Serial Communications)

For RS-232C

CPU	Serial communications	Connection diagram	PT																																						
Q02CPU Q02HCPU Q06HCPU Q12HCPU Q25HCPU Q00CPU Q00HCPU Q01CPU Q00JCPU	QJ71C24-R2 QJ71C24N-R2	<p>Mitsubishi Serial Communications Module</p> <table border="1" style="display: inline-table; margin-right: 20px;"> <thead> <tr> <th>Pin No.</th> <th>Signal</th> </tr> </thead> <tbody> <tr><td>1</td><td>CD</td></tr> <tr><td>2</td><td>RD</td></tr> <tr><td>3</td><td>SD</td></tr> <tr><td>4</td><td>DTR(ER)</td></tr> <tr><td>5</td><td>SG</td></tr> <tr><td>6</td><td>SDR(DR)</td></tr> <tr><td>7</td><td>RS</td></tr> <tr><td>8</td><td>CS</td></tr> <tr><td>9</td><td>RI</td></tr> </tbody> </table> <table border="1" style="display: inline-table;"> <thead> <tr> <th>Pin No.</th> <th>Signal</th> </tr> </thead> <tbody> <tr><td>1</td><td>+</td></tr> <tr><td>2</td><td>-</td></tr> <tr><td>3</td><td>FG</td></tr> <tr><td>4</td><td>SD</td></tr> <tr><td>5</td><td>RD</td></tr> <tr><td>6</td><td>NC</td></tr> <tr><td>7</td><td>NC</td></tr> <tr><td>8</td><td>SG</td></tr> </tbody> </table>	Pin No.	Signal	1	CD	2	RD	3	SD	4	DTR(ER)	5	SG	6	SDR(DR)	7	RS	8	CS	9	RI	Pin No.	Signal	1	+	2	-	3	FG	4	SD	5	RD	6	NC	7	NC	8	SG	NV3W(-V1), NV4W, or NV3Q for RS-232C
Pin No.	Signal																																								
1	CD																																								
2	RD																																								
3	SD																																								
4	DTR(ER)																																								
5	SG																																								
6	SDR(DR)																																								
7	RS																																								
8	CS																																								
9	RI																																								
Pin No.	Signal																																								
1	+																																								
2	-																																								
3	FG																																								
4	SD																																								
5	RD																																								
6	NC																																								
7	NC																																								
8	SG																																								

### 1-3-2 Connecting to RS-232C Port on Q00 or Q01 CPU

For RS-232C

CPU	Link interface	Connection diagram	PT																																
Q00CPU Q01CPU	RS-232C port on CPU Unit	<p>Mini DIN 6-pin connector on Mitsubishi PLC</p> <table border="1" style="display: inline-table; margin-right: 20px;"> <thead> <tr> <th>Pin No.</th> <th>Signal</th> </tr> </thead> <tbody> <tr><td>1</td><td>RD</td></tr> <tr><td>2</td><td>SD</td></tr> <tr><td>3</td><td>SG</td></tr> <tr><td>4</td><td>-</td></tr> <tr><td>5</td><td>DR</td></tr> <tr><td>6</td><td>ER</td></tr> </tbody> </table> <table border="1" style="display: inline-table;"> <thead> <tr> <th>Pin No.</th> <th>Signal</th> </tr> </thead> <tbody> <tr><td>1</td><td>+</td></tr> <tr><td>2</td><td>-</td></tr> <tr><td>3</td><td>FG</td></tr> <tr><td>4</td><td>SD</td></tr> <tr><td>5</td><td>RD</td></tr> <tr><td>6</td><td>NC</td></tr> <tr><td>7</td><td>NC</td></tr> <tr><td>8</td><td>SG</td></tr> </tbody> </table>	Pin No.	Signal	1	RD	2	SD	3	SG	4	-	5	DR	6	ER	Pin No.	Signal	1	+	2	-	3	FG	4	SD	5	RD	6	NC	7	NC	8	SG	NV3W(-V1), NV4W, or NV3Q for RS-232C
Pin No.	Signal																																		
1	RD																																		
2	SD																																		
3	SG																																		
4	-																																		
5	DR																																		
6	ER																																		
Pin No.	Signal																																		
1	+																																		
2	-																																		
3	FG																																		
4	SD																																		
5	RD																																		
6	NC																																		
7	NC																																		
8	SG																																		

## 1-4 MELSEC-Q (CPU) Series

PLC Model Selection      Select Mitsubishi MELSEC-Q (CPU) Series.

### Applicable Devices

	Bit/word devices	No.	Comments
Bit devices	Input relays	X 000000 to X 001FFF	
	Output relays	Y 000000 to Y 001FFF	
	Auxiliary relays	M 000000 to M 032767	
	Latched relays	L 000000 to L 032767	
	Annunciators	F 000000 to F 032767	
	Edge relays	V 000000 to V 032767	
	Link relays	B 000000 to B 007FFF	
	Special relays	SM 000000 to SM 002047	
	Link special relays	SB 000000 to SB 0007FF	
	Step relays	S 000000 to S 008191	
	Timer contacts	TS 000000 to TS 023087	
	Timer coils	TC 000000 to TC 023087	
	Accumulative timer contacts	SS 000000 to SS 023087	
	Accumulative timer coils	SC 000000 to SC 023087	
	Counter contacts	CS 000000 to CS 023087	
Counter coils	CC 000000 to CC 023087		
Word devices	Input relays	X 000000 to X 001FF0	The first digit of the address must be 0.
	Output relays	Y 000000 to Y 001FF0	The first digit of the address must be 0.
	Auxiliary relays	M 000000 to M 032752	The address must be a multiple of 16.
	Latched relays	L 000000 to L 032752	
	Annunciators	F 000000 to F 032752	
	Edge relays	V 000000 to V 032752	
	Link relays	B 000000 to B 007FF0	The first digit of the address must be 0.
	Special relays	SM 000000 to SM 002032	
	Link special relays	SB 000000 to SB 0007F0	
	Step relays	S 000000 to S 008176	
	Timer current values	TN 000000 to TN 023087	
	Accumulative timer current values	SN 000000 to SN 023087	
	Counter current values	CN 000000 to CN 023087	
	Data registers	D 000000 to D 025983	
	Link registers	W 000000 to W 00657F	
	Link special registers	SW 000000 to SW 0007FF	
	File registers (for normal access)	R 000000 to R 032767	
	File registers (for serial access)	ZR 000000 to ZR 1042431	
Special registers	SD 000000 to SD 002047		

**Communications Settings** The following communications settings are recommended for the PT and PLC.

■ **PT Communications Settings (Set from the NV-Designer using the NV Configuration.)**

Item	Setting
PLC station number	0
Baud rate	19,200 bps
Data bits	8
Stop bits	1
Parity	Odd

■ **PLC Communications Settings**

It is not necessary to make any communications settings.

### 1-4-1 Connecting to the MELSEC-Q (CPU) Series

For RS-232C

CPU	Link interface	Connection diagram	PT																																
Q02CPU Q02HCPU Q06HCPU Q12HCPU Q25HCPU	RS-232C port on CPU Unit	<p>Mini DIN 6-pin connector on Mitsubishi PLC</p> <table border="1"> <thead> <tr> <th>Pin No.</th> <th>Signal</th> </tr> </thead> <tbody> <tr> <td>1</td> <td>RD</td> </tr> <tr> <td>2</td> <td>SD</td> </tr> <tr> <td>3</td> <td>SG</td> </tr> <tr> <td>4</td> <td>-</td> </tr> <tr> <td>5</td> <td>DR</td> </tr> <tr> <td>6</td> <td>ER</td> </tr> </tbody> </table> <p>To power supply</p> <table border="1"> <thead> <tr> <th>Pin No.</th> <th>Signal</th> </tr> </thead> <tbody> <tr> <td>1</td> <td>+</td> </tr> <tr> <td>2</td> <td>-</td> </tr> <tr> <td>3</td> <td>FG</td> </tr> <tr> <td>4</td> <td>SD</td> </tr> <tr> <td>5</td> <td>RD</td> </tr> <tr> <td>6</td> <td>NC</td> </tr> <tr> <td>7</td> <td>NC</td> </tr> <tr> <td>8</td> <td>SG</td> </tr> </tbody> </table>	Pin No.	Signal	1	RD	2	SD	3	SG	4	-	5	DR	6	ER	Pin No.	Signal	1	+	2	-	3	FG	4	SD	5	RD	6	NC	7	NC	8	SG	NV3W (-V1), NV4W, or NV3Q for RS-232C
Pin No.	Signal																																		
1	RD																																		
2	SD																																		
3	SG																																		
4	-																																		
5	DR																																		
6	ER																																		
Pin No.	Signal																																		
1	+																																		
2	-																																		
3	FG																																		
4	SD																																		
5	RD																																		
6	NC																																		
7	NC																																		
8	SG																																		



# 1-5 MELSEC-A Series (Computer Link)

**PLC Model Selection**      Select Mitsubishi MELSEC-A (Computer Link) Series.

## Applicable Devices

Bit/word devices		No.	Comments
Bit devices	Input relays	X 0000 to X 07FF	
	Output relays	Y 0000 to Y 07FF	
	Auxiliary relays	M 0000 to M 2047	
	Link relays	B 0000 to B 03FF	
	Timer contacts	TS 0000 to TS 0255	
	Counter contacts	CS 0000 to CS 0255	
Word devices	Input relays	X 0000 to X 07F0	The first digit of the address must be 0.
	Output relays	Y 0000 to Y 07F0	The first digit of the address must be 0.
	Auxiliary relays	M 0000 to M 2032	The address must be a multiple of 16.
	Link relays	B 0000 to B 03FF	The first digit of the address must be 0.
	Timer current values	TN 0000 to TN 0255	
	Counter current values	CN 0000 to CN 0255	
	Data registers	D 0000 to D 1023	
	Link registers	W 0000 to W 03FF	
	File registers	R 0000 to R 8191	

- Note**
- (1) The maximum values that can be set by the PT are given.
  - (2) The addressable memory ranges depend on the model of PLC that is used. Refer to the user manuals for your PLC for details.

**Communications Settings**      The following communications settings are recommended for the PT and PLC.

■ **PT Communications Settings (Set from the NV-Designer using the NV Configuration.)**

Item	Setting
PLC station number	0
Baud rate	19,200 bps
Data bits	7
Stop bits	1
Parity	Even

■ **PLC Communications Settings**

Item	Setting
Station number	0
Baud rate	19,200 bps
Data bits	7
Stop bits	1
Parity	Even
Checksum	Enabled
Interface	RS-232C
Communications protocol	Type 4

### 1-5-1 Connecting to the MELSEC-A Series (Computer Link Unit)

For 24-VDC power

CPU	Computer link unit	Connection diagram	PT																																						
A1N A2N A3N	AJ71C24 AJ71C24-S3 AJ71C24-S6 AJ71C24-S8 AJ71U24 (A2N only)	<p>Mitsubishi Computer Link Module</p> <table border="1"> <thead> <tr> <th>Pin No.</th> <th>Signal</th> </tr> </thead> <tbody> <tr><td>1</td><td>FG</td></tr> <tr><td>2</td><td>SD</td></tr> <tr><td>3</td><td>RD</td></tr> <tr><td>4</td><td>RS</td></tr> <tr><td>5</td><td>CS</td></tr> <tr><td>6</td><td>DR</td></tr> <tr><td>7</td><td>SG</td></tr> <tr><td>8</td><td>CD</td></tr> <tr><td>20</td><td>ER</td></tr> </tbody> </table> <table border="1"> <thead> <tr> <th>Pin No.</th> <th>Signal</th> </tr> </thead> <tbody> <tr><td>1</td><td>+</td></tr> <tr><td>2</td><td>-</td></tr> <tr><td>3</td><td>FG</td></tr> <tr><td>4</td><td>SD</td></tr> <tr><td>5</td><td>RD</td></tr> <tr><td>6</td><td>NC</td></tr> <tr><td>7</td><td>NC</td></tr> <tr><td>8</td><td>SG</td></tr> </tbody> </table>	Pin No.	Signal	1	FG	2	SD	3	RD	4	RS	5	CS	6	DR	7	SG	8	CD	20	ER	Pin No.	Signal	1	+	2	-	3	FG	4	SD	5	RD	6	NC	7	NC	8	SG	NV3W (-V1), NV4W, or NV3Q for RS-232C
Pin No.	Signal																																								
1	FG																																								
2	SD																																								
3	RD																																								
4	RS																																								
5	CS																																								
6	DR																																								
7	SG																																								
8	CD																																								
20	ER																																								
Pin No.	Signal																																								
1	+																																								
2	-																																								
3	FG																																								
4	SD																																								
5	RD																																								
6	NC																																								
7	NC																																								
8	SG																																								
A1S A1SJ A2SH A1SH A2CCPU24	A1SJ71C24-R2 A1SJ71UC24-R2 A1SJ71UC24-R2 RS-232C port on CPU Unit	<p>Mitsubishi Computer Link Module</p> <table border="1"> <thead> <tr> <th>Pin No.</th> <th>Signal</th> </tr> </thead> <tbody> <tr><td>1</td><td>CD</td></tr> <tr><td>2</td><td>RD</td></tr> <tr><td>3</td><td>SD</td></tr> <tr><td>4</td><td>ER</td></tr> <tr><td>5</td><td>SG</td></tr> <tr><td>6</td><td>DR</td></tr> <tr><td>7</td><td>RS</td></tr> <tr><td>8</td><td>CS</td></tr> <tr><td>9</td><td>-</td></tr> </tbody> </table> <table border="1"> <thead> <tr> <th>Pin No.</th> <th>Signal</th> </tr> </thead> <tbody> <tr><td>1</td><td>+</td></tr> <tr><td>2</td><td>-</td></tr> <tr><td>3</td><td>FG</td></tr> <tr><td>4</td><td>SD</td></tr> <tr><td>5</td><td>RD</td></tr> <tr><td>6</td><td>NC</td></tr> <tr><td>7</td><td>NC</td></tr> <tr><td>8</td><td>SG</td></tr> </tbody> </table>	Pin No.	Signal	1	CD	2	RD	3	SD	4	ER	5	SG	6	DR	7	RS	8	CS	9	-	Pin No.	Signal	1	+	2	-	3	FG	4	SD	5	RD	6	NC	7	NC	8	SG	NV3W (-V1), NV4W, or NV3Q for RS-232C
Pin No.	Signal																																								
1	CD																																								
2	RD																																								
3	SD																																								
4	ER																																								
5	SG																																								
6	DR																																								
7	RS																																								
8	CS																																								
9	-																																								
Pin No.	Signal																																								
1	+																																								
2	-																																								
3	FG																																								
4	SD																																								
5	RD																																								
6	NC																																								
7	NC																																								
8	SG																																								

## SECTION 2

# Connecting to Panasonic Electric Works PLCs

2-1	FP-X Series . . . . .	14
2-1-1	Connecting to an FP-X-series Tool Port. . . . .	15
2-1-2	Connecting to an FP-X-series COM Port. . . . .	15
2-2	FPΣ Series . . . . .	18
2-2-1	Connecting to an FPΣ-series Tool Port. . . . .	19
2-2-2	Connecting to an FPΣ-series COM Port. . . . .	20
2-3	FP0/FP0R Series . . . . .	22
2-3-1	Connecting to an FP0/FP0R-series Tool Port. . . . .	23
2-3-2	Connecting to an FP0/FP0R-series COM Port. . . . .	24
2-4	FP-e Series . . . . .	25
2-4-1	Connecting to an FP-e-series Tool Port . . . . .	26
2-4-2	Connecting to an FP-e-series COM Port . . . . .	27
2-5	MEWNET FP2/FP2SH Series . . . . .	28
2-5-1	Connecting to an FP2-series or FP2SH-series Tool Port . . . . .	29
2-5-2	Connecting to an FP2-series or FP2SH-series COM Port . . . . .	30
2-6	FP2 Computer Communications Unit (CCU). . . . .	31
2-6-1	Connecting to an FP2 Computer Communications Unit . . . . .	32
2-7	FP7 Series . . . . .	33
2-7-1	RS232C connections. . . . .	36
2-7-2	RS422 connections . . . . .	38
2-7-3	RS-485 connections . . . . .	40
2-7-4	Clock Settings. . . . .	43

## 2-1 FP-X Series

**PLC Model Selection** Select Panasonic FP Series.

### Applicable Devices

	Bit/word devices	No.	Comments
Bit devices	Input relays	X 0000 to X 511F	
	Output relays	Y 0000 to Y 511F	
	Internal relays	R 0000 to R 886F	
	Link relays	L 0000 to L 639F	
	Timers	T 0000 to T 3071	
	Counters	C 0000 to C 3071	
	Special internal relays	R 9000 to R 910F	
Word devices	Input relays	WX 0000 to WX 511	
	Output relays	WY 0000 to WY 511	
	Internal relays	WR 0000 to WR 886	
	Link relays	WL 0000 to WL 639	
	Data registers	DT 00000 to DT 10239	
	Link data registers	LD 0000 to LD 8447	
	Timer/counter set value area	SV 0000 to SV 3071	
	Timer/counter elapsed value area	EV 0000 to EV 3071	
	File registers	FL 00000 to FL 32764	
	Special data registers	DT 90000 to DT 90511	

- Note**
- (1) The maximum values that can be set by the PT are given.
  - (2) The addressable memory ranges depend on the model of PLC that is used. Refer to the user manuals for your PLC for details.

**Communications Settings** The following communications settings are recommended for the PT and PLC.

#### ■ PT Communications Settings (Set from the NV-Designer using the NV Configuration.)

Item	Setting
Baud rate	19,200 bps
Data bits	8
Stop bits	1
Parity	Enabled, odd

#### ■ PLC Communications Settings

Item	Setting
Communications mode	Computer link
Baud rate	19,200 bps
Data bits	8
Stop bits	1
Parity	Enabled, odd
End code	CR
Start code	No STX
Unit number	1
Modem connection	No connection

### 2-1-1 Connecting to an FP-X-series Tool Port

**Connection Configuration between PLC and PT**

Connect the PT to the tool port on the FP-X-series PLC as shown below.

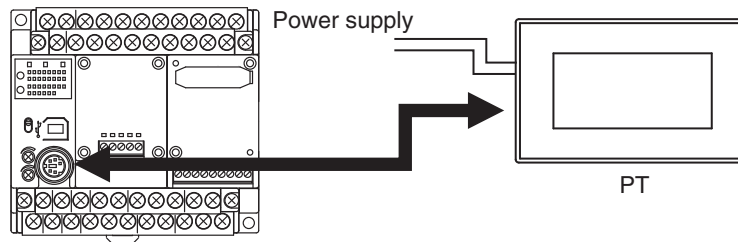

**Communications Format Setting**

System register number	Item	Setting
410	Tool port unit number	1
412	Modem connection	No connection
413	Data length	8 bits
	Parity check	Enabled, odd
	Stop bits	1 bit
	End code	CR (fixed)
	Start code	No STX (fixed)
414	Tool port baud rate setting	9,600 bps

**Connection Diagram**

PLC	Connection diagram	PT																														
FP-X Communications cable: Mini DIN 5-pin connector -- Loose wires	<table border="1" style="display: inline-table; margin-right: 20px;"> <caption>PLC</caption> <thead> <tr> <th>Pin No.</th> <th>Signal</th> </tr> </thead> <tbody> <tr><td>1</td><td>SG</td></tr> <tr><td>2</td><td>SD</td></tr> <tr><td>3</td><td>RD</td></tr> <tr><td>4</td><td>-</td></tr> <tr><td>5</td><td>-</td></tr> </tbody> </table> <table border="1" style="display: inline-table;"> <caption>PT (RS-232C)</caption> <thead> <tr> <th>Pin No.</th> <th>Signal</th> </tr> </thead> <tbody> <tr><td>1</td><td>+</td></tr> <tr><td>2</td><td>-</td></tr> <tr><td>3</td><td>FG</td></tr> <tr><td>4</td><td>SD</td></tr> <tr><td>5</td><td>RD</td></tr> <tr><td>6</td><td>NC</td></tr> <tr><td>7</td><td>NC</td></tr> <tr><td>8</td><td>SG</td></tr> </tbody> </table>	Pin No.	Signal	1	SG	2	SD	3	RD	4	-	5	-	Pin No.	Signal	1	+	2	-	3	FG	4	SD	5	RD	6	NC	7	NC	8	SG	NV3W (-V1), NV4W, or NV3Q for RS-232C
Pin No.	Signal																															
1	SG																															
2	SD																															
3	RD																															
4	-																															
5	-																															
Pin No.	Signal																															
1	+																															
2	-																															
3	FG																															
4	SD																															
5	RD																															
6	NC																															
7	NC																															
8	SG																															

### 2-1-2 Connecting to an FP-X-series COM Port

**Connection Configuration between PLC and PT**

Connect the PT to the COM port on the FP-X-series PLC as shown below.

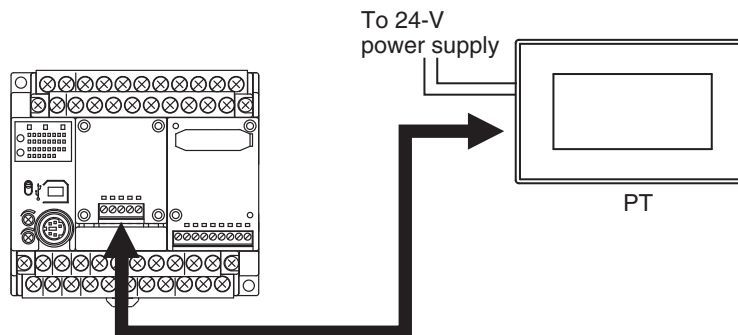

Connection Diagram

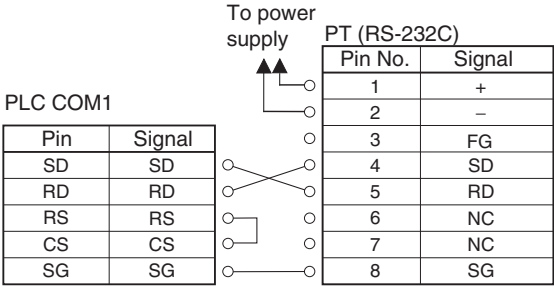
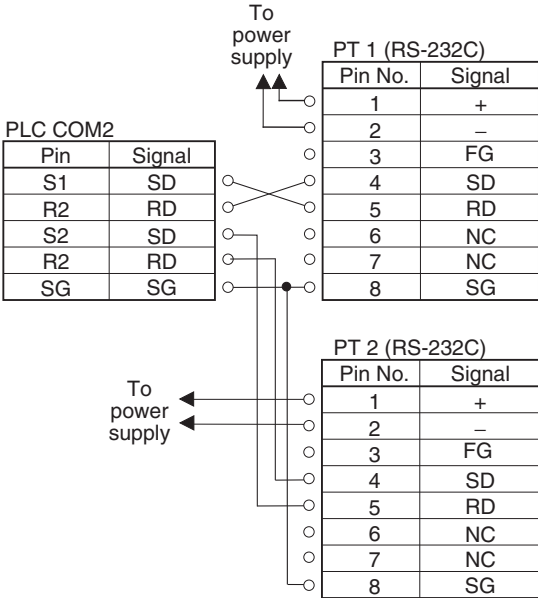
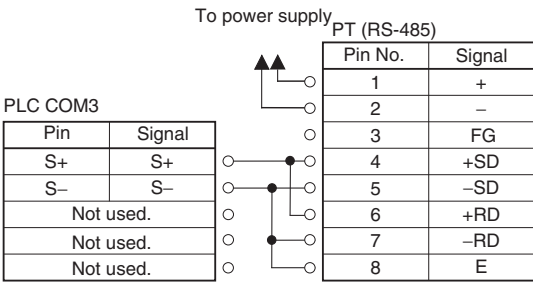
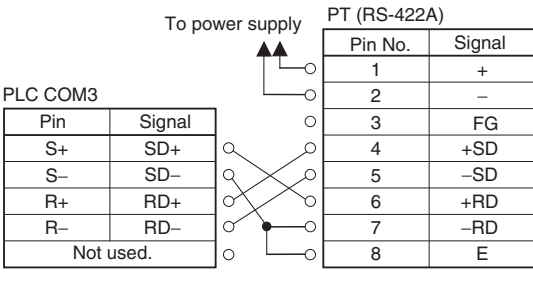
PLC	Connection diagram	PT																																																												
<p>FP-X Mode for RS-232C, 1 channel (AFPX-COM1) Communications cable: Loose wires</p>	 <p>To power supply</p> <p>PLC COM1</p> <table border="1" data-bbox="395 369 611 533"> <thead> <tr> <th>Pin</th> <th>Signal</th> </tr> </thead> <tbody> <tr><td>SD</td><td>SD</td></tr> <tr><td>RD</td><td>RD</td></tr> <tr><td>RS</td><td>RS</td></tr> <tr><td>CS</td><td>CS</td></tr> <tr><td>SG</td><td>SG</td></tr> </tbody> </table> <p>PT (RS-232C)</p> <table border="1" data-bbox="715 289 951 533"> <thead> <tr> <th>Pin No.</th> <th>Signal</th> </tr> </thead> <tbody> <tr><td>1</td><td>+</td></tr> <tr><td>2</td><td>-</td></tr> <tr><td>3</td><td>FG</td></tr> <tr><td>4</td><td>SD</td></tr> <tr><td>5</td><td>RD</td></tr> <tr><td>6</td><td>NC</td></tr> <tr><td>7</td><td>NC</td></tr> <tr><td>8</td><td>SG</td></tr> </tbody> </table> <p><b>Note</b> Connect the RS and CS terminals on the AFPX-COM1.</p>	Pin	Signal	SD	SD	RD	RD	RS	RS	CS	CS	SG	SG	Pin No.	Signal	1	+	2	-	3	FG	4	SD	5	RD	6	NC	7	NC	8	SG	<p>NV3W (-V1), NV4W, or NV3Q for RS-232C</p>																														
Pin	Signal																																																													
SD	SD																																																													
RD	RD																																																													
RS	RS																																																													
CS	CS																																																													
SG	SG																																																													
Pin No.	Signal																																																													
1	+																																																													
2	-																																																													
3	FG																																																													
4	SD																																																													
5	RD																																																													
6	NC																																																													
7	NC																																																													
8	SG																																																													
<p>FP-X RS-232C, 2 channels (AFPX-COM2) Communications cable: Loose wires</p>	 <p>To power supply</p> <p>PLC COM2</p> <table border="1" data-bbox="395 730 611 894"> <thead> <tr> <th>Pin</th> <th>Signal</th> </tr> </thead> <tbody> <tr><td>S1</td><td>SD</td></tr> <tr><td>R2</td><td>RD</td></tr> <tr><td>S2</td><td>SD</td></tr> <tr><td>R2</td><td>RD</td></tr> <tr><td>SG</td><td>SG</td></tr> </tbody> </table> <p>PT 1 (RS-232C)</p> <table border="1" data-bbox="715 651 935 894"> <thead> <tr> <th>Pin No.</th> <th>Signal</th> </tr> </thead> <tbody> <tr><td>1</td><td>+</td></tr> <tr><td>2</td><td>-</td></tr> <tr><td>3</td><td>FG</td></tr> <tr><td>4</td><td>SD</td></tr> <tr><td>5</td><td>RD</td></tr> <tr><td>6</td><td>NC</td></tr> <tr><td>7</td><td>NC</td></tr> <tr><td>8</td><td>SG</td></tr> </tbody> </table> <p>PT 2 (RS-232C)</p> <table border="1" data-bbox="715 949 935 1188"> <thead> <tr> <th>Pin No.</th> <th>Signal</th> </tr> </thead> <tbody> <tr><td>1</td><td>+</td></tr> <tr><td>2</td><td>-</td></tr> <tr><td>3</td><td>FG</td></tr> <tr><td>4</td><td>SD</td></tr> <tr><td>5</td><td>RD</td></tr> <tr><td>6</td><td>NC</td></tr> <tr><td>7</td><td>NC</td></tr> <tr><td>8</td><td>SG</td></tr> </tbody> </table> <p>To power supply</p>	Pin	Signal	S1	SD	R2	RD	S2	SD	R2	RD	SG	SG	Pin No.	Signal	1	+	2	-	3	FG	4	SD	5	RD	6	NC	7	NC	8	SG	Pin No.	Signal	1	+	2	-	3	FG	4	SD	5	RD	6	NC	7	NC	8	SG	<p>NV3W (-V1), NV4W, or NV3Q for RS-232C</p>												
Pin	Signal																																																													
S1	SD																																																													
R2	RD																																																													
S2	SD																																																													
R2	RD																																																													
SG	SG																																																													
Pin No.	Signal																																																													
1	+																																																													
2	-																																																													
3	FG																																																													
4	SD																																																													
5	RD																																																													
6	NC																																																													
7	NC																																																													
8	SG																																																													
Pin No.	Signal																																																													
1	+																																																													
2	-																																																													
3	FG																																																													
4	SD																																																													
5	RD																																																													
6	NC																																																													
7	NC																																																													
8	SG																																																													
<p>FP-X RS-485/RS-422A, 1 channel (AFPX-COM3) Communications cable: Loose wires</p>	 <p>To power supply</p> <p>PLC COM3</p> <table border="1" data-bbox="395 1329 611 1493"> <thead> <tr> <th>Pin</th> <th>Signal</th> </tr> </thead> <tbody> <tr><td>S+</td><td>S+</td></tr> <tr><td>S-</td><td>S-</td></tr> <tr><td></td><td>Not used.</td></tr> <tr><td></td><td>Not used.</td></tr> <tr><td></td><td>Not used.</td></tr> </tbody> </table> <p>PT (RS-485)</p> <table border="1" data-bbox="715 1249 930 1493"> <thead> <tr> <th>Pin No.</th> <th>Signal</th> </tr> </thead> <tbody> <tr><td>1</td><td>+</td></tr> <tr><td>2</td><td>-</td></tr> <tr><td>3</td><td>FG</td></tr> <tr><td>4</td><td>+SD</td></tr> <tr><td>5</td><td>-SD</td></tr> <tr><td>6</td><td>+RD</td></tr> <tr><td>7</td><td>-RD</td></tr> <tr><td>8</td><td>E</td></tr> </tbody> </table> <p><b>Note</b> Turn ON pins 1 to 4 on the switch on the back of the AFPX-COM3.</p>  <p>To power supply</p> <p>PLC COM3</p> <table border="1" data-bbox="395 1686 611 1850"> <thead> <tr> <th>Pin</th> <th>Signal</th> </tr> </thead> <tbody> <tr><td>S+</td><td>SD+</td></tr> <tr><td>S-</td><td>SD-</td></tr> <tr><td>R+</td><td>RD+</td></tr> <tr><td>R-</td><td>RD-</td></tr> <tr><td></td><td>Not used.</td></tr> </tbody> </table> <p>PT (RS-422A)</p> <table border="1" data-bbox="715 1606 930 1850"> <thead> <tr> <th>Pin No.</th> <th>Signal</th> </tr> </thead> <tbody> <tr><td>1</td><td>+</td></tr> <tr><td>2</td><td>-</td></tr> <tr><td>3</td><td>FG</td></tr> <tr><td>4</td><td>+SD</td></tr> <tr><td>5</td><td>-SD</td></tr> <tr><td>6</td><td>+RD</td></tr> <tr><td>7</td><td>-RD</td></tr> <tr><td>8</td><td>E</td></tr> </tbody> </table> <p><b>Note</b> Turn OFF pins 1 to 3 and turn ON pin 4 on the switch on the back of the AFPX-COM3.</p>	Pin	Signal	S+	S+	S-	S-		Not used.		Not used.		Not used.	Pin No.	Signal	1	+	2	-	3	FG	4	+SD	5	-SD	6	+RD	7	-RD	8	E	Pin	Signal	S+	SD+	S-	SD-	R+	RD+	R-	RD-		Not used.	Pin No.	Signal	1	+	2	-	3	FG	4	+SD	5	-SD	6	+RD	7	-RD	8	E	<p>NV3W (-V1), NV4W, or NV3Q for RS-485</p> <p>NV3W (-V1), NV4W, or NV3Q for RS-422A</p>
Pin	Signal																																																													
S+	S+																																																													
S-	S-																																																													
	Not used.																																																													
	Not used.																																																													
	Not used.																																																													
Pin No.	Signal																																																													
1	+																																																													
2	-																																																													
3	FG																																																													
4	+SD																																																													
5	-SD																																																													
6	+RD																																																													
7	-RD																																																													
8	E																																																													
Pin	Signal																																																													
S+	SD+																																																													
S-	SD-																																																													
R+	RD+																																																													
R-	RD-																																																													
	Not used.																																																													
Pin No.	Signal																																																													
1	+																																																													
2	-																																																													
3	FG																																																													
4	+SD																																																													
5	-SD																																																													
6	+RD																																																													
7	-RD																																																													
8	E																																																													

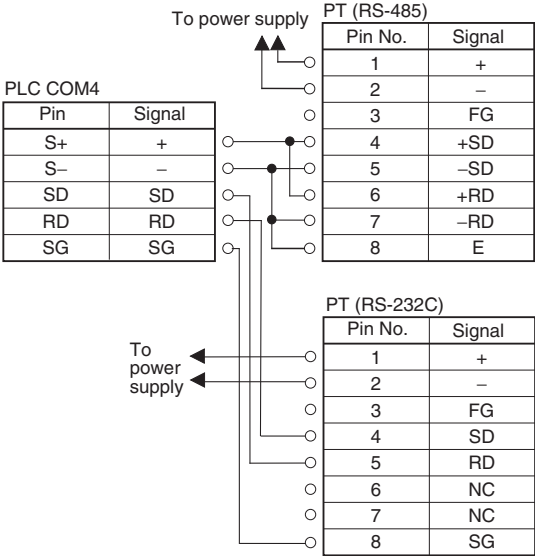
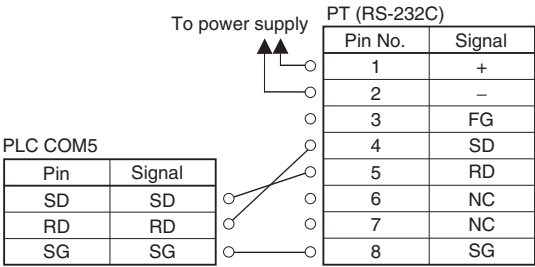
PLC	Connection diagram	PT
<p>FP-X RS-485, 1 channel and RS-232C, 1 channel (AFPX- COM4) Communications cable: Loose wires</p>	 <p>The diagram shows the wiring for AFPX-COM4. On the left, a table for PLC COM4 lists signals: S+ (+), S- (-), SD (SD), RD (RD), and SG (SG). On the right, two tables for PT are shown. The top table is for PT (RS-485) with signals: Pin 1 (+), Pin 2 (-), Pin 3 (FG), Pin 4 (+SD), Pin 5 (-SD), Pin 6 (+RD), Pin 7 (-RD), and Pin 8 (E). The bottom table is for PT (RS-232C) with signals: Pin 1 (+), Pin 2 (-), Pin 3 (FG), Pin 4 (SD), Pin 5 (RD), Pin 6 (NC), Pin 7 (NC), and Pin 8 (SG). Arrows indicate connections from PLC COM4 to the PT tables and to power supply terminals.</p> <p><b>Note</b> Turn ON the switch on the back of the AFPX-COM4 Cas- sette.</p>	<p>NV3W (-V1), NV4W, or NV3Q for RS-485 and RS-232C</p>
<p>FP-X Ethernet, 1 channel and RS-232C 1 channel (AFPX-COM5) <b>Note</b> Connection via Ethernet is not possible. Communications cable: Loose wires</p>	 <p>The diagram shows the wiring for AFPX-COM5. On the left, a table for PLC COM5 lists signals: SD (SD), RD (RD), and SG (SG). On the right, a table for PT (RS-232C) lists signals: Pin 1 (+), Pin 2 (-), Pin 3 (FG), Pin 4 (SD), Pin 5 (RD), Pin 6 (NC), Pin 7 (NC), and Pin 8 (SG). Arrows indicate connections from PLC COM5 to the PT table and to power supply terminals.</p>	<p>NV3W (-V1), NV4W, or NV3Q for RS-232C</p>

## 2-2 FPΣ Series

**PLC Model Selection** Select Panasonic FP Series.

### Applicable Devices

	Bit/word devices	No.	Comments
Bit devices	Input relays	X 0000 to X 511F	
	Output relays	Y 0000 to Y 511F	
	Internal relays	R 0000 to R 886F	
	Link relays	L 0000 to L 639F	
	Timers	T 0000 to T 3071	
	Counters	C 0000 to C 3071	
	Special internal relays	R 9000 to R 910F	
Word devices	Input relays	WX 0000 to WX 511	
	Output relays	WY 0000 to WY 511	
	Internal relays	WR 0000 to WR 886	
	Link relays	WL 0000 to WL 639	
	Data registers	DT 00000 to DT 10239	
	Link data registers	LD 0000 to LD 8447	
	Timer/counter set value area	SV 0000 to SV 3071	
	Timer/counter elapsed value area	EV 0000 to EV 3071	
	File registers	FL 00000 to FL 32764	
	Special data registers	DT 90000 to DT 90511	

- Note**
- (1) The maximum values that can be set by the PT are given.
  - (2) The addressable memory ranges depend on the model of PLC that is used. Refer to the user manuals for your PLC for details.

**Communications Settings** The following communications settings are recommended for the PT and PLC.

■ **PT Communications Settings (Set from the NV-Designer using the NV Configuration.)**

Item	Setting
Baud rate	19,200 bps
Data bits	8
Stop bits	1
Parity	Enabled, odd

■ **PLC Communications Settings**

Item	Setting
Communications mode	Computer link
Baud rate	19,200 bps
Data bits	8
Stop bits	1
Parity	Enabled, odd
End code	CR
Start code	No STX
Unit number	1
Modem connection	No connection



### 2-2-1 Connecting to an FPΣ-series Tool Port

#### Connection Configuration between PLC and PT

You can connect directly to the tool port on an FPΣ-series PLC.

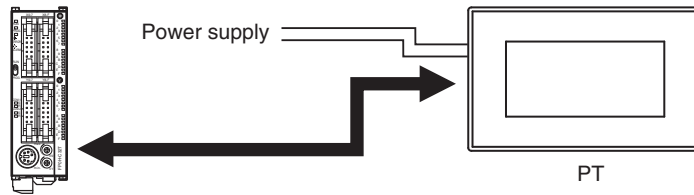

#### Communications Format Setting

System register number	Item	Setting
410	Tool port unit number	1
412	Modem connection	No connection
413	Data length	8 bits
	Parity check	Enabled, odd
	Stop bits	1 bit
	End code	CR (fixed)
	Start code	No STX (fixed)
414	Tool port baud rate setting	9,600 bps

#### Connection Diagram

PLC	Connection diagram	PT																														
FPΣ Communications cable: Mini DIN 5-pin connector -- Loose wires	<p>The connection diagram shows the wiring between the PLC and the PT. The PLC has a 5-pin connector with signals SG (Pin 1), SD (Pin 2), RD (Pin 3), and two unused pins (Pin 4 and 5). The PT has an 8-pin connector with signals + (Pin 1), - (Pin 2), FG (Pin 3), SD (Pin 4), RD (Pin 5), and three unused pins (Pin 6, 7, 8). A 24-V power supply is connected to the PT pins 1 and 2.</p> <table border="1" style="display: inline-table; margin-right: 20px;"> <caption>PLC</caption> <thead> <tr> <th>Pin No.</th> <th>Signal</th> </tr> </thead> <tbody> <tr><td>1</td><td>SG</td></tr> <tr><td>2</td><td>SD</td></tr> <tr><td>3</td><td>RD</td></tr> <tr><td>4</td><td>-</td></tr> <tr><td>5</td><td>-</td></tr> </tbody> </table> <table border="1" style="display: inline-table;"> <caption>PT (RS-232C)</caption> <thead> <tr> <th>Pin No.</th> <th>Signal</th> </tr> </thead> <tbody> <tr><td>1</td><td>+</td></tr> <tr><td>2</td><td>-</td></tr> <tr><td>3</td><td>FG</td></tr> <tr><td>4</td><td>SD</td></tr> <tr><td>5</td><td>RD</td></tr> <tr><td>6</td><td>NC</td></tr> <tr><td>7</td><td>NC</td></tr> <tr><td>8</td><td>SG</td></tr> </tbody> </table>	Pin No.	Signal	1	SG	2	SD	3	RD	4	-	5	-	Pin No.	Signal	1	+	2	-	3	FG	4	SD	5	RD	6	NC	7	NC	8	SG	NV3W (-V1), NV4W, or NV3Q for RS-232C
Pin No.	Signal																															
1	SG																															
2	SD																															
3	RD																															
4	-																															
5	-																															
Pin No.	Signal																															
1	+																															
2	-																															
3	FG																															
4	SD																															
5	RD																															
6	NC																															
7	NC																															
8	SG																															

## 2-2-2 Connecting to an FPΣ-series COM Port

**Connection Configuration between PLC and PT** You can connect directly to the COM port on an FPΣ-series PLC.

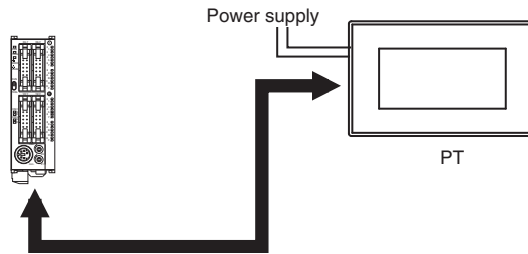

**Connection Diagram for FPΣ COM Port 1 (RS-232C, 1 Channel)**

PLC	Connection diagram	PT																														
FPΣ RS-232C, 1 channel (COM1)	<p>To power supply</p> <table border="1"> <caption>PLC COM1</caption> <thead> <tr> <th>Pin</th> <th>Signal</th> </tr> </thead> <tbody> <tr> <td>SD</td> <td>SD</td> </tr> <tr> <td>RD</td> <td>RD</td> </tr> <tr> <td>RS</td> <td>RS</td> </tr> <tr> <td>CS</td> <td>CS</td> </tr> <tr> <td>SG</td> <td>SG</td> </tr> </tbody> </table> <table border="1"> <caption>PT (RS-232C)</caption> <thead> <tr> <th>Pin No.</th> <th>Signal</th> </tr> </thead> <tbody> <tr> <td>1</td> <td>+</td> </tr> <tr> <td>2</td> <td>-</td> </tr> <tr> <td>3</td> <td>FG</td> </tr> <tr> <td>4</td> <td>SD</td> </tr> <tr> <td>5</td> <td>RD</td> </tr> <tr> <td>6</td> <td>NC</td> </tr> <tr> <td>7</td> <td>NC</td> </tr> <tr> <td>8</td> <td>SG</td> </tr> </tbody> </table> <p><b>Note</b> Connect the RS and CS terminals on COM1.</p>	Pin	Signal	SD	SD	RD	RD	RS	RS	CS	CS	SG	SG	Pin No.	Signal	1	+	2	-	3	FG	4	SD	5	RD	6	NC	7	NC	8	SG	NV3W (-V1), NV4W, or NV3Q for RS-232C
Pin	Signal																															
SD	SD																															
RD	RD																															
RS	RS																															
CS	CS																															
SG	SG																															
Pin No.	Signal																															
1	+																															
2	-																															
3	FG																															
4	SD																															
5	RD																															
6	NC																															
7	NC																															
8	SG																															

**Connection Diagram for FPΣ COM Port 2 (RS-232C, 2 Channels)**

PLC	Connection diagram	PT																																																
FPΣ RS-232C, 2 chan- nels (COMs)	<p>To power supply</p> <table border="1"> <caption>PLC COM2</caption> <thead> <tr> <th>Pin</th> <th>Signal</th> </tr> </thead> <tbody> <tr> <td>S1</td> <td>SD</td> </tr> <tr> <td>R2</td> <td>RD</td> </tr> <tr> <td>S2</td> <td>SD</td> </tr> <tr> <td>R2</td> <td>RD</td> </tr> <tr> <td>SG</td> <td>SG</td> </tr> </tbody> </table> <table border="1"> <caption>PT1 (RS-232C)</caption> <thead> <tr> <th>Pin No.</th> <th>Signal</th> </tr> </thead> <tbody> <tr> <td>1</td> <td>+</td> </tr> <tr> <td>2</td> <td>-</td> </tr> <tr> <td>3</td> <td>FG</td> </tr> <tr> <td>4</td> <td>SD</td> </tr> <tr> <td>5</td> <td>RD</td> </tr> <tr> <td>6</td> <td>NC</td> </tr> <tr> <td>7</td> <td>NC</td> </tr> <tr> <td>8</td> <td>SG</td> </tr> </tbody> </table> <table border="1"> <caption>PT2 (RS-232C)</caption> <thead> <tr> <th>Pin No.</th> <th>Signal</th> </tr> </thead> <tbody> <tr> <td>1</td> <td>+</td> </tr> <tr> <td>2</td> <td>-</td> </tr> <tr> <td>3</td> <td>FG</td> </tr> <tr> <td>4</td> <td>SD</td> </tr> <tr> <td>5</td> <td>RD</td> </tr> <tr> <td>6</td> <td>NC</td> </tr> <tr> <td>7</td> <td>NC</td> </tr> <tr> <td>8</td> <td>SG</td> </tr> </tbody> </table> <p>To power supply</p>	Pin	Signal	S1	SD	R2	RD	S2	SD	R2	RD	SG	SG	Pin No.	Signal	1	+	2	-	3	FG	4	SD	5	RD	6	NC	7	NC	8	SG	Pin No.	Signal	1	+	2	-	3	FG	4	SD	5	RD	6	NC	7	NC	8	SG	NV3W (-V1), NV4W, or NV3Q for RS-232C
Pin	Signal																																																	
S1	SD																																																	
R2	RD																																																	
S2	SD																																																	
R2	RD																																																	
SG	SG																																																	
Pin No.	Signal																																																	
1	+																																																	
2	-																																																	
3	FG																																																	
4	SD																																																	
5	RD																																																	
6	NC																																																	
7	NC																																																	
8	SG																																																	
Pin No.	Signal																																																	
1	+																																																	
2	-																																																	
3	FG																																																	
4	SD																																																	
5	RD																																																	
6	NC																																																	
7	NC																																																	
8	SG																																																	

**Connection Diagram for FPΣ COM Port 3 (RS-485, 1 Channel)**

PLC	Connection diagram	PT																												
FPΣ RS-485, 1 channel (COM3)	<p style="text-align: center;">To power supply</p> <table border="1" style="margin-left: auto; margin-right: auto;"> <caption>PT (RS-485)</caption> <thead> <tr> <th>Pin No.</th> <th>Signal</th> </tr> </thead> <tbody> <tr><td>1</td><td>+</td></tr> <tr><td>2</td><td>-</td></tr> <tr><td>3</td><td>FG</td></tr> <tr><td>4</td><td>+SD</td></tr> <tr><td>5</td><td>-SD</td></tr> <tr><td>6</td><td>+RD</td></tr> <tr><td>7</td><td>-RD</td></tr> <tr><td>8</td><td>E Terminator setting (built-in 120 Ω resistance)</td></tr> </tbody> </table> <p><b>Note</b> Communications Format Setting</p> <table border="1" style="margin-left: auto; margin-right: auto;"> <thead> <tr> <th>Item</th> <th>Setting</th> </tr> </thead> <tbody> <tr> <td>COM port 1 unit number</td> <td>1</td> </tr> <tr> <td>COM port 1 communications mode</td> <td>Computer link</td> </tr> <tr> <td>COM port 1 transmission format</td> <td>8 bits, odd parity, 1 stop bit, terminal CR (fixed), no STX</td> </tr> <tr> <td>COM port 1 baud rate setting</td> <td>38,400, 57,600, or 115,200 bps</td> </tr> </tbody> </table>	Pin No.	Signal	1	+	2	-	3	FG	4	+SD	5	-SD	6	+RD	7	-RD	8	E Terminator setting (built-in 120 Ω resistance)	Item	Setting	COM port 1 unit number	1	COM port 1 communications mode	Computer link	COM port 1 transmission format	8 bits, odd parity, 1 stop bit, terminal CR (fixed), no STX	COM port 1 baud rate setting	38,400, 57,600, or 115,200 bps	NV3W (-V1), NV4W, or NV3Q for RS-485
Pin No.	Signal																													
1	+																													
2	-																													
3	FG																													
4	+SD																													
5	-SD																													
6	+RD																													
7	-RD																													
8	E Terminator setting (built-in 120 Ω resistance)																													
Item	Setting																													
COM port 1 unit number	1																													
COM port 1 communications mode	Computer link																													
COM port 1 transmission format	8 bits, odd parity, 1 stop bit, terminal CR (fixed), no STX																													
COM port 1 baud rate setting	38,400, 57,600, or 115,200 bps																													

**Connection Diagram for FPΣ COM Port 4 (RS-485, 1 Channel and RS-232C, 1 Channel)**

PLC	Connection diagram	PT																																				
FPΣ RS-485, 1 channel and RS-232C, 1 channel (COM4)	<p style="text-align: center;">To power supply</p> <table border="1" style="margin-left: auto; margin-right: auto;"> <caption>PT (RS-485)</caption> <thead> <tr> <th>Pin No.</th> <th>Signal</th> </tr> </thead> <tbody> <tr><td>1</td><td>+</td></tr> <tr><td>2</td><td>-</td></tr> <tr><td>3</td><td>FG</td></tr> <tr><td>4</td><td>+SD</td></tr> <tr><td>5</td><td>-SD</td></tr> <tr><td>6</td><td>+RD</td></tr> <tr><td>7</td><td>-RD</td></tr> <tr><td>8</td><td>E</td></tr> </tbody> </table> <table border="1" style="margin-left: auto; margin-right: auto;"> <caption>PT (RS-232C)</caption> <thead> <tr> <th>Pin No.</th> <th>Signal</th> </tr> </thead> <tbody> <tr><td>1</td><td>+</td></tr> <tr><td>2</td><td>-</td></tr> <tr><td>3</td><td>FG</td></tr> <tr><td>4</td><td>SD</td></tr> <tr><td>5</td><td>RD</td></tr> <tr><td>6</td><td>NC</td></tr> <tr><td>7</td><td>NC</td></tr> <tr><td>8</td><td>SG</td></tr> </tbody> </table> <p style="text-align: center;">To power supply</p> <p><b>Note</b> Turn ON the switch on the back of the COM4 Cassette.</p>	Pin No.	Signal	1	+	2	-	3	FG	4	+SD	5	-SD	6	+RD	7	-RD	8	E	Pin No.	Signal	1	+	2	-	3	FG	4	SD	5	RD	6	NC	7	NC	8	SG	NV3W (-V1), NV4W, or NV3Q for RS-422A/ 485 and RS- 232C
Pin No.	Signal																																					
1	+																																					
2	-																																					
3	FG																																					
4	+SD																																					
5	-SD																																					
6	+RD																																					
7	-RD																																					
8	E																																					
Pin No.	Signal																																					
1	+																																					
2	-																																					
3	FG																																					
4	SD																																					
5	RD																																					
6	NC																																					
7	NC																																					
8	SG																																					

## 2-3 FP0/FP0R Series

**PLC Model Selection**      Select Panasonic FP Series.

### Applicable Devices

	Bit/word devices	No.	Comments
Bit devices	Input relays	X 0000 to X 511F	
	Output relays	Y 0000 to Y 511F	
	Internal relays	R 0000 to R 886F	
	Link relays	L 0000 to L 639F	
	Timers	T 0000 to T 3071	
	Counters	C 0000 to C 3071	
	Special internal relays	R 9000 to R 910F	
Word devices	Input relays	WX 0000 to WX 511	
	Output relays	WY 0000 to WY 511	
	Internal relays	WR 0000 to WR 886	
	Link relays	WL 0000 to WL 639	
	Data registers	DT 00000 to DT 10239	
	Link data registers	LD 0000 to LD 8447	
	Timer/counter set value area	SV 0000 to SV 3071	
	Timer/counter elapsed value area	EV 0000 to EV 3071	
	File registers	FL 00000 to FL 32764	
	Special data registers	DT 90000 to DT 90511	

- Note**
- (1) The maximum values that can be set by the PT are given.
  - (2) The addressable memory ranges depend on the model of PLC that is used. Refer to the user manuals for your PLC for details.

**Communications Settings**      The following communications settings are recommended for the PT and PLC.

#### ■ PT Communications Settings (Set from the NV-Designer using the NV Configuration.)

Item	Setting
Baud rate	19,200 bps
Data bits	8
Stop bits	1
Parity	Enabled, odd

#### ■ PLC Communications Settings

Item	Setting
Communications mode	Computer link
Baud rate	19,200 bps
Data bits	8
Stop bits	1
Parity	Enabled, odd
End code	CR
Start code	No STX
Unit number	1
Modem connection	No connection

### 2-3-1 Connecting to an FP0/FP0R-series Tool Port

#### Connection Configuration between PLC and PT

Connect the PT to the tool port on the FP0/FP0R-series PLC as shown below.

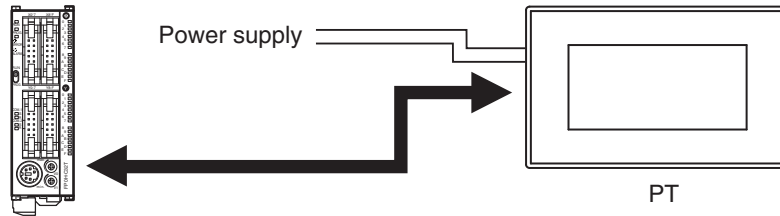

#### Communications Format Setting

System register number	Item	Setting
410	Tool port unit number	1
412	Modem connection	No connection
413	Data length	8 bits
	Parity check	Enabled, odd
	Stop bits	1 bit
	End code	CR (fixed)
	Start code	No STX (fixed)
414	Tool port baud rate setting	9,600 bps

#### Connection Diagram

PLC	Connection diagram	PT																														
FP0/FP0R Communications cable: Mini DIN 5-pin connector -- Loose wires	<table border="1" style="display: inline-table; margin-right: 20px;"> <caption>PLC</caption> <thead> <tr> <th>Pin No.</th> <th>Signal</th> </tr> </thead> <tbody> <tr><td>1</td><td>SG</td></tr> <tr><td>2</td><td>SD</td></tr> <tr><td>3</td><td>RD</td></tr> <tr><td>4</td><td>-</td></tr> <tr><td>5</td><td>-</td></tr> </tbody> </table> <table border="1" style="display: inline-table;"> <caption>PT (RS-232C)</caption> <thead> <tr> <th>Pin No.</th> <th>Signal</th> </tr> </thead> <tbody> <tr><td>1</td><td>+</td></tr> <tr><td>2</td><td>-</td></tr> <tr><td>3</td><td>FG</td></tr> <tr><td>4</td><td>SD</td></tr> <tr><td>5</td><td>RD</td></tr> <tr><td>6</td><td>NC</td></tr> <tr><td>7</td><td>NC</td></tr> <tr><td>8</td><td>SG</td></tr> </tbody> </table>	Pin No.	Signal	1	SG	2	SD	3	RD	4	-	5	-	Pin No.	Signal	1	+	2	-	3	FG	4	SD	5	RD	6	NC	7	NC	8	SG	NV3W (-V1), NV4W, or NV3Q for RS-232C
Pin No.	Signal																															
1	SG																															
2	SD																															
3	RD																															
4	-																															
5	-																															
Pin No.	Signal																															
1	+																															
2	-																															
3	FG																															
4	SD																															
5	RD																															
6	NC																															
7	NC																															
8	SG																															

### 2-3-2 Connecting to an FP0/FP0R-series COM Port

**Connection Configuration between PLC and PT**

Connect the PT to the COM port on the FP0/FP0R-series PLC as shown below.

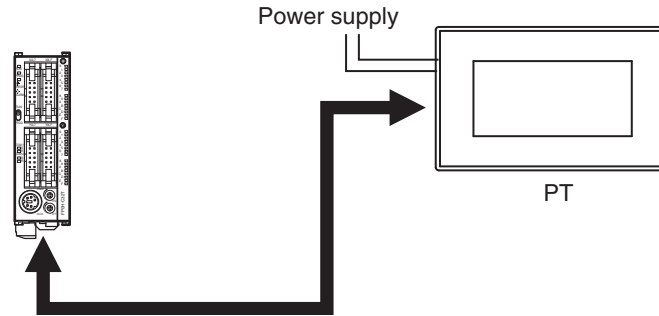

**Connection Diagram for FP0 COM Port (RS-232C)**

PLC	Connection diagram	PT																										
FP0/FP0R Communications cable: Loose wires	<div style="display: flex; align-items: center;"> <div style="margin-right: 20px;"> <p>PLC COM1</p> <table border="1" style="border-collapse: collapse;"> <thead> <tr> <th>Pin</th> <th>Signal</th> </tr> </thead> <tbody> <tr> <td>S</td> <td>SD</td> </tr> <tr> <td>R</td> <td>RD</td> </tr> <tr> <td>G</td> <td>SG</td> </tr> </tbody> </table> </div> <div> <p>To power supply</p> <table border="1" style="border-collapse: collapse;"> <thead> <tr> <th>Pin No.</th> <th>Signal</th> </tr> </thead> <tbody> <tr> <td>1</td> <td>+</td> </tr> <tr> <td>2</td> <td>-</td> </tr> <tr> <td>3</td> <td>FG</td> </tr> <tr> <td>4</td> <td>SD</td> </tr> <tr> <td>5</td> <td>RD</td> </tr> <tr> <td>6</td> <td>NC</td> </tr> <tr> <td>7</td> <td>NC</td> </tr> <tr> <td>8</td> <td>SG</td> </tr> </tbody> </table> </div> </div>	Pin	Signal	S	SD	R	RD	G	SG	Pin No.	Signal	1	+	2	-	3	FG	4	SD	5	RD	6	NC	7	NC	8	SG	NV3W (-V1), NV4W, or NV3Q for RS-232C
Pin	Signal																											
S	SD																											
R	RD																											
G	SG																											
Pin No.	Signal																											
1	+																											
2	-																											
3	FG																											
4	SD																											
5	RD																											
6	NC																											
7	NC																											
8	SG																											

## 2-4 FP-e Series

**PLC Model Selection**                      Select Panasonic FP Series.

### Applicable Devices

	Bit/word devices	No.	Comments
Bit devices	Input relays	X 0000 to X 511F	
	Output relays	Y 0000 to Y 511F	
	Internal relays	R 0000 to R 886F	
	Link relays	L 0000 to L 639F	
	Timers	T 0000 to T 3071	
	Counters	C 0000 to C 3071	
	Special internal relays	R 9000 to R 910F	
Word devices	Input relays	WX 0000 to WX 511	
	Output relays	WY 0000 to WY 511	
	Internal relays	WR 0000 to WR 886	
	Link relays	WL 0000 to WL 639	
	Data registers	DT 00000 to DT 10239	
	Link data registers	LD 0000 to LD 8447	
	Timer/counter set value area	SV 0000 to SV 3071	
	Timer/counter elapsed value area	EV 0000 to EV 3071	
	File registers	FL 00000 to FL 32764	
	Special data registers	DT 90000 to DT 90511	

- Note**
- (1) The maximum values that can be set by the PT are given.
  - (2) The addressable memory ranges depend on the model of PLC that is used. Refer to the user manuals for your PLC for details.

**Communications Settings**                      The following communications settings are recommended for the PT and PLC.

■ **PT Communications Settings (Set from the NV-Designer using the NV Configuration.)**

Item	Setting
Baud rate	19,200 bps
Data bits	8
Stop bits	1
Parity	Enabled, odd

■ **PLC Communications Settings**

Item	Setting
Communications mode	Computer link
Baud rate	19,200 bps
Data bits	8
Stop bits	1
Parity	Enabled, odd
End code	CR
Start code	No STX
Unit number	1
Modem connection	No connection

### 2-4-1 Connecting to an FP-e-series Tool Port

**Connection Configuration between PLC and PT**

Connect the PT to the tool port on the FP-e-series PLC as shown below.

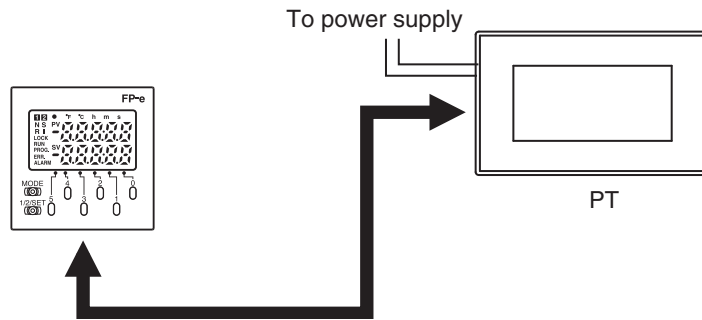

**Communications Format Setting**

System register number	Item	Setting
410	Tool port unit number	1
412	Modem connection	No connection
413	Data length	8 bits
	Parity check	Enabled, odd
	Stop bits	1 bit
	End code	CR (fixed)
	Start code	No STX (fixed)
414	Tool port baud rate setting	9,600 bps

**Connection Diagram**

PLC	Connection diagram	PT																														
FP-e Communications cable: Mini DIN 5-pin connector -- Loose wires	<p style="text-align: center;">To 24-V power supply</p> <table border="1" style="display: inline-table; margin-right: 20px;"> <caption>PLC</caption> <thead> <tr> <th>Pin No.</th> <th>Signal</th> </tr> </thead> <tbody> <tr><td>1</td><td>SG</td></tr> <tr><td>2</td><td>SD</td></tr> <tr><td>3</td><td>RD</td></tr> <tr><td>4</td><td>-</td></tr> <tr><td>5</td><td>-</td></tr> </tbody> </table> <table border="1" style="display: inline-table;"> <caption>PT (RS-232C)</caption> <thead> <tr> <th>Pin No.</th> <th>Signal</th> </tr> </thead> <tbody> <tr><td>1</td><td>+</td></tr> <tr><td>2</td><td>-</td></tr> <tr><td>3</td><td>FG</td></tr> <tr><td>4</td><td>SD</td></tr> <tr><td>5</td><td>RD</td></tr> <tr><td>6</td><td>NC</td></tr> <tr><td>7</td><td>NC</td></tr> <tr><td>8</td><td>SG</td></tr> </tbody> </table>	Pin No.	Signal	1	SG	2	SD	3	RD	4	-	5	-	Pin No.	Signal	1	+	2	-	3	FG	4	SD	5	RD	6	NC	7	NC	8	SG	NV3W (-V1), NV4W, or NV3Q for RS-232C
Pin No.	Signal																															
1	SG																															
2	SD																															
3	RD																															
4	-																															
5	-																															
Pin No.	Signal																															
1	+																															
2	-																															
3	FG																															
4	SD																															
5	RD																															
6	NC																															
7	NC																															
8	SG																															



## 2-4-2 Connecting to an FP-e-series COM Port

### Connection Configuration between PLC and PT

Connect the PT to the COM port on the FP-e-series PLC as shown below.

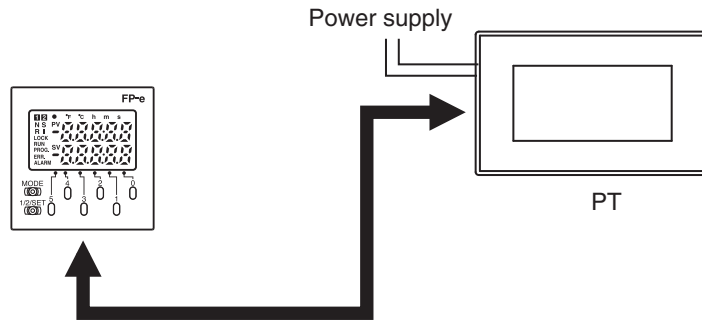

Connection Diagram for FP-e COM Port (RS-232C or RS-485)

PLC	Connection diagram	PT																		
FP-e Communications cable: Loose wires	<p style="text-align: center;">To power supply</p> <table border="1" style="float: right; margin-left: 20px;"> <thead> <tr> <th>Pin No.</th> <th>Signal</th> </tr> </thead> <tbody> <tr><td>1</td><td>+</td></tr> <tr><td>2</td><td>-</td></tr> <tr><td>3</td><td>FG</td></tr> <tr><td>4</td><td>SD</td></tr> <tr><td>5</td><td>RD</td></tr> <tr><td>6</td><td>NC</td></tr> <tr><td>7</td><td>NC</td></tr> <tr><td>8</td><td>SG</td></tr> </tbody> </table>	Pin No.	Signal	1	+	2	-	3	FG	4	SD	5	RD	6	NC	7	NC	8	SG	NV3W (-V1), NV4W, or NV3Q for RS-232C
Pin No.	Signal																			
1	+																			
2	-																			
3	FG																			
4	SD																			
5	RD																			
6	NC																			
7	NC																			
8	SG																			
	<p style="text-align: center;">To power supply</p> <table border="1" style="float: right; margin-left: 20px;"> <thead> <tr> <th>Pin No.</th> <th>Signal</th> </tr> </thead> <tbody> <tr><td>1</td><td>+</td></tr> <tr><td>2</td><td>-</td></tr> <tr><td>3</td><td>FG</td></tr> <tr><td>4</td><td>+SD</td></tr> <tr><td>5</td><td>-SD</td></tr> <tr><td>6</td><td>+RD</td></tr> <tr><td>7</td><td>-RD</td></tr> <tr><td>8</td><td>E</td></tr> </tbody> </table>	Pin No.	Signal	1	+	2	-	3	FG	4	+SD	5	-SD	6	+RD	7	-RD	8	E	NV3W (-V1), NV4W, or NV3Q for RS-485
Pin No.	Signal																			
1	+																			
2	-																			
3	FG																			
4	+SD																			
5	-SD																			
6	+RD																			
7	-RD																			
8	E																			

## 2-5 MEWNET FP2/FP2SH Series

**PLC Model Selection**                      Select Panasonic FP Series.

### Applicable Devices

	Bit/word devices	No.	Comments
Bit devices	Input relays	X 0000 to X 511F	
	Output relays	Y 0000 to Y 511F	
	Internal relays	R 0000 to R 886F	
	Link relays	L 0000 to L 639F	
	Timers	T 0000 to T 3071	
	Counters	C 0000 to C 3071	
	Special internal relays	R 9000 to R 910F	
Word devices	Input relays	WX 0000 to WX 511	
	Output relays	WY 0000 to WY 511	
	Internal relays	WR 0000 to WR 886	
	Link relays	WL 0000 to WL 639	
	Data registers	DT 00000 to DT 10239	
	Link data registers	LD 0000 to LD 8447	
	Timer/counter set value area	SV 0000 to SV 3071	
	Timer/counter elapsed value area	EV 0000 to EV 3071	
	File registers	FL 00000 to FL 32764	
	Special data registers	DT 90000 to DT 90511	

- Note**
- (1) The maximum values that can be set by the PT are given.
  - (2) The addressable memory ranges depend on the model of PLC that is used. Refer to the user manuals for your PLC for details.

**Communications Settings**                      The following communications settings are recommended for the PT and PLC.

#### ■ PT Communications Settings (Set from the NV-Designer using the NV Configuration.)

Item	Setting
Baud rate	19,200 bps
Data bits	8
Stop bits	1
Parity	Enabled, odd

#### ■ PLC Communications Settings

Item	Setting
Communications mode	Computer link
Baud rate	19,200 bps
Data bits	8
Stop bits	1
Parity	Enabled, odd
End code	CR
Start code	No STX
Unit number	1
Modem connection	No connection

### 2-5-1 Connecting to an FP2-series or FP2SH-series Tool Port

**Connection Configuration between PLC and PT**

You can directly connect to the tool port on an FP2-series or FP2SH-series PLC as shown below.

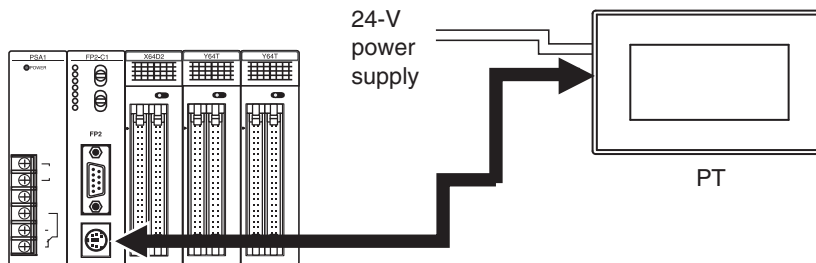

**Communications Format Setting**

System register number	Item	Setting
410	Tool port unit number	1
412	Modem connection	No connection
413	Data length	8 bits
	Parity check	Enabled, odd
	Stop bits	1 bit
	End code	CR (fixed)
	Start code	No STX (fixed)
414	Tool port baud rate setting	9,600 bps

**Connection Diagram**

PLC	Connection diagram	PT																														
FP2, FP2SH Communications cable: Mini DIN 5-pin connector -- Loose wires	<p>To 24-V power supply</p> <table border="1"> <thead> <tr> <th>PLC</th> <th>Signal</th> </tr> </thead> <tbody> <tr> <td>1</td> <td>SG</td> </tr> <tr> <td>2</td> <td>SD</td> </tr> <tr> <td>3</td> <td>RD</td> </tr> <tr> <td>4</td> <td>—</td> </tr> <tr> <td>5</td> <td>—</td> </tr> </tbody> </table> <p>PT (RS-232C)</p> <table border="1"> <thead> <tr> <th>Pin No.</th> <th>Signal</th> </tr> </thead> <tbody> <tr> <td>1</td> <td>+</td> </tr> <tr> <td>2</td> <td>—</td> </tr> <tr> <td>3</td> <td>FG</td> </tr> <tr> <td>4</td> <td>SD</td> </tr> <tr> <td>5</td> <td>RD</td> </tr> <tr> <td>6</td> <td>NC</td> </tr> <tr> <td>7</td> <td>NC</td> </tr> <tr> <td>8</td> <td>SG</td> </tr> </tbody> </table>	PLC	Signal	1	SG	2	SD	3	RD	4	—	5	—	Pin No.	Signal	1	+	2	—	3	FG	4	SD	5	RD	6	NC	7	NC	8	SG	NV3W (-V1), NV4W, or NV3Q for RS-232C
PLC	Signal																															
1	SG																															
2	SD																															
3	RD																															
4	—																															
5	—																															
Pin No.	Signal																															
1	+																															
2	—																															
3	FG																															
4	SD																															
5	RD																															
6	NC																															
7	NC																															
8	SG																															

## 2-5-2 Connecting to an FP2-series or FP2SH-series COM Port

### Connection Configuration between PLC and PT

You can directly connect to the COM port on an FP2-series or FP2SH-series PLC as shown below.

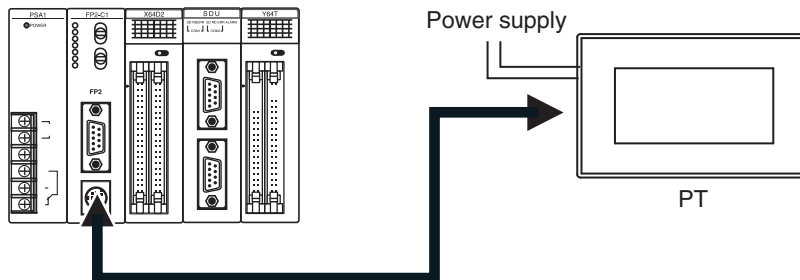

### Communications Format Setting

System register number	Item	Setting	System register value
412	Purpose of using RS-232C port	Computer link	K1
413	Data length	8 bits	K3
	Parity check	Enabled	
	Parity	Odd	
	Stop bits	1 bit	
	End code	CR	
	Start code	No STX	
414	Tool port baud rate setting	9,600 bps	K1
415	Unit number	1	K1
416	Modem connection	No connection	HO

### Connection Diagram for FP2 or FP2SH COM Port (RS-232C)

PLC	Connection diagram	PT																																						
FP2, FP2SH Communications cable: D-sub 9-pin connector -- Loose wires	<p>To power supply</p> <p>PLC</p> <table border="1"> <thead> <tr> <th>Pin No.</th> <th>Signal</th> </tr> </thead> <tbody> <tr><td>1</td><td>FG</td></tr> <tr><td>2</td><td>SD</td></tr> <tr><td>3</td><td>RD</td></tr> <tr><td>4</td><td>RS</td></tr> <tr><td>5</td><td>CS</td></tr> <tr><td>6</td><td>NC</td></tr> <tr><td>7</td><td>SG</td></tr> <tr><td>8</td><td>NC</td></tr> <tr><td>9</td><td>ER</td></tr> </tbody> </table> <p>PT (RS-232C)</p> <table border="1"> <thead> <tr> <th>Pin No.</th> <th>Signal</th> </tr> </thead> <tbody> <tr><td>1</td><td>+</td></tr> <tr><td>2</td><td>-</td></tr> <tr><td>3</td><td>FG</td></tr> <tr><td>4</td><td>SD</td></tr> <tr><td>5</td><td>RD</td></tr> <tr><td>6</td><td>NC</td></tr> <tr><td>7</td><td>NC</td></tr> <tr><td>8</td><td>SG</td></tr> </tbody> </table>	Pin No.	Signal	1	FG	2	SD	3	RD	4	RS	5	CS	6	NC	7	SG	8	NC	9	ER	Pin No.	Signal	1	+	2	-	3	FG	4	SD	5	RD	6	NC	7	NC	8	SG	NV3W (-V1), NV4W, or NV3Q for RS-232C
Pin No.	Signal																																							
1	FG																																							
2	SD																																							
3	RD																																							
4	RS																																							
5	CS																																							
6	NC																																							
7	SG																																							
8	NC																																							
9	ER																																							
Pin No.	Signal																																							
1	+																																							
2	-																																							
3	FG																																							
4	SD																																							
5	RD																																							
6	NC																																							
7	NC																																							
8	SG																																							

## 2-6 FP2 Computer Communications Unit (CCU)

**PLC Model Selection**                      Select Panasonic FP Series.

### Applicable Devices

	Bit/word devices	No.	Comments
Bit devices	Input relays	X 0000 to X 511F	
	Output relays	Y 0000 to Y 511F	
	Internal relays	R 0000 to R 886F	
	Link relays	L 0000 to L 639F	
	Timers	T 0000 to T 3071	
	Counters	C 0000 to C 3071	
	Special internal relays	R 9000 to R 910F	
Word devices	Input relays	WX 0000 to WX 511	
	Output relays	WY 0000 to WY 511	
	Internal relays	WR 0000 to WR 886	
	Link relays	WL 0000 to WL 639	
	Data registers	DT 00000 to DT 10239	
	Link data registers	LD 0000 to LD 8447	
	Timer/counter set value area	SV 0000 to SV 3071	
	Timer/counter elapsed value area	EV 0000 to EV 3071	
	File registers	FL 00000 to FL 32764	
	Special data registers	DT 90000 to DT 90511	

- Note**
- (1) The maximum values that can be set by the PT are given.
  - (2) The addressable memory ranges depend on the model of PLC that is used. Refer to the user manuals for your PLC for details.

**Communications Settings**                      The following communications settings are recommended for the PT and PLC.

■ **PT Communications Settings (Set from the NV-Designer using the NV Configuration.)**

Item	Setting
Baud rate	19,200 bps
Data bits	8
Stop bits	1
Parity	Enabled, odd

■ **PLC Communications Settings**

Item	Setting
Communications mode	Computer link
Baud rate	19,200 bps
Data bits	8
Stop bits	1
Parity	Enabled, odd
End code	CR
Start code	No STX
Unit number	1
Modem connection	No connection

**Note** With the FP2 CCU, the parity check is always odd and there is always one stop bit.

### 2-6-1 Connecting to an FP2 Computer Communications Unit

**Connection Configuration between PLC and PT**

You can connect to an FP2 Computer Communications Unit as shown below.

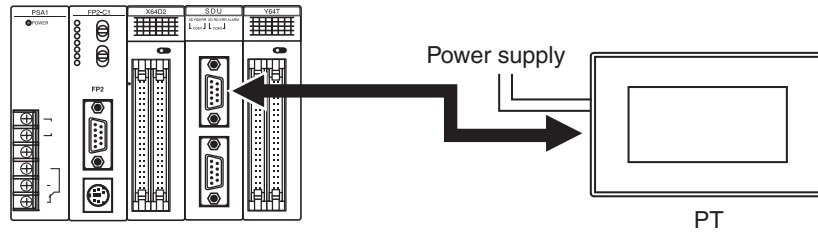

**DIP Switch Settings on the Back of the FP2 Computer Communications Unit**

Pin	Item	Setting	Switch status
1	Reserved by system.	---	ON
2	COM1 baud rate	9,600 bps	OFF
3			ON
4	COM1 data length	8 bits	ON
5	Reserved by system.		ON
6	COM2 baud rate	9,600 bps	OFF
7			ON
8	COM2 data length	8 bits	ON

**Connection Diagram**

PLC	Connection diagram	PT
FP2 Computer Communications Unit Communications cable: D-sub 9-pin connector -- Loose wires		NV3W (-V1), NV4W, or NV3Q for RS-232C

## 2-7 FP7 Series

### ■ Connectable NV Models and Versions

Models	Applicable Versions
NV3W	Not supported.
NV3W-V1	Ver. 2.00 or higher
NV4W	Ver. 2.00 or higher
NV3Q	Ver. 2.00 or higher

### ■ PLC Model Selection

Select Panasonic FP7 Series.

### Applicable Devices

Bit/Word/Double-word devices		No.	Output*1	Local*2	Slot*3	Comments
Bit devices	Input memory	X 0000 to X 511F	Supported	Supported	Not supported	
	Output memory	Y 0000 to Y 511F	Supported	Supported	Not supported	
	Internal relay	R 00000 to R 2047F	Supported	Supported	Not supported	
	Link relay	L 00000 to L 1023F	Supported	Supported	Not supported	
	Timer contact	T 0000 to T 4095	Not supported	Supported	Not supported	
	Counter contact	C 0000 to C 1023	Not supported	Supported	Not supported	
	Pulse relay	P 0000 to P 255F	Not supported	Supported	Not supported	
	Error alarm relay	E 0000 to E 255F	Not supported	Not supported	Not supported	
	System relay	SR 0000 to SR 149F	Not supported	Not supported	Not supported	
	Direct input	IN 000 to IN 63F	Not supported	Not supported	Supported	
	Direct output	OT 000 to OT 63F	Supported	Not supported	Supported	
	Link register*4	LD 00000.0 to LD 16383.F	Supported	Supported	Not supported	
	Data register*4	DT 000000.0 to DT 999423.F	Supported	Supported	Not supported	
	Unit memory*4	UM 000000.0 to UM 524287.F	Supported	Supported	Supported	
Word devices	Input memory	WX 000 to WX 511	Supported	Supported	Not supported	
	Output memory	WY 000 to WY 511	Supported	Supported	Not supported	
	Internal relay	WR 0000 to WR 2047	Supported	Supported	Not supported	
	Link relay	WL 0000 to WL 1023	Supported	Supported	Not supported	
	System relay	WS 000 to WS 149	Not supported	Not supported	Not supported	
	Link register	LD 00000 to LD 16383	Supported	Supported	Not supported	
	Data register	DT 000000 to DT 999423	Supported	Supported	Not supported	
	System data	SD 000 to SD 119	Not supported	Not supported	Not supported	
	Direct input	WI 00 to WI 63	Not supported	Not supported	Supported	
	Direct output	WO 00 to WO 63	Supported	Not supported	Supported	
	Unit memory	UM 000000 to UM 524287	Supported	Not supported	Supported	
Double-word devices	Timer set value	TS 0000 to TS 4095	Supported	Supported	Not supported	
	Timer elapsed value	TE 0000 to TE 4095	Supported	Supported	Not supported	
	Counter set value	CS 0000 to CS 1023	Supported	Supported	Not supported	
	Counter elapsed value	CE 0000 to CE 1023	Supported	Supported	Not supported	
	Index register	I 0 to I E	Supported	Not supported	Not supported	

- \*1 No data can be written in the devices noted with "Not supported".
- \*2 The devices noted with "Supported" can be used as local devices. To use as a local device, designate a program block number. The number can be specified from 1 to 468 and is to be expressed by "PB?\_" followed by a symbol.
- \*3 For the devices noted with "Supported", a slot number must be designated. The number can be specified from 1 to 16 and is to be expressed by "S?:" followed by a symbol.
- \*4 To use a link register, data register, or unit memory as a bit device, a bit number must be designated. Specify the number after a period "." preceded by the device number.

**Note**

- (1) The maximum values that can be set by the PT are given.
- (2) The addressable memory ranges depend on the model of PLC that is used. Refer to the user manuals for your PLC for details.



**Communications Settings** The following communications settings are recommended for the PT and PLC.

■ **PT Communications Settings (Set from the NV-Designer using the NV Configuration.)**

Item	Setting
Baud rate	The same setting as that of FP7
Data length	The same setting as that of FP7
Stop bits	1
Parity bit	The same setting as that of FP7

■ **PLC Communications Settings**

Item	Setting
COM0	Perform the setting when connecting the PT with the FP7 COM0 port.
COM1 Setting	Perform the setting when connecting the PT with 1CH of a one-channel or two-channel-type communication cassette.
COM2 Setting	Perform the setting when connecting the PT with 2CH of a two-channel-type communication cassette.
Communications mode	MEWTOCOL-7
Station number	Set an arbitrary station number. When specifying connections to more than one PLC, this station number should correspond with the one designated on the PT side.
Baud rate	The same setting as that of PT
Data length	The same setting as that of PT
Parity	The same setting as that of PT
Stop bits	1
CS/RS	None
Transmission delay	For the RS232C or RS422 communications, set it to "0" For the RS485 communications, set and adjust the value according to the actual connection.
Start code STX	None
Modem initialization	No initialization

- Note**
- (1) You cannot use the communication speed of 230400 bps for connection. Select a communication speed and format that conform to the NV-series PTs.
  - (2) You cannot modify the time setting of the FP7 internal clock from the PT.

### 2-7-1 RS232C connections

#### Connections between the FP7 COM0 port and the NV-series PT (24V/RS232C type)

PLC	Connection diagram	PT																																
FP7 Communications cable: Loose wires	<p>FP7 COM0 port</p> <table border="1"> <thead> <tr> <th>Pin No.</th> <th>Signal</th> </tr> </thead> <tbody> <tr><td>SD</td><td>SD</td></tr> <tr><td>RD</td><td>RD</td></tr> <tr><td>SG</td><td>SG</td></tr> <tr><td>24V</td><td>+24V</td></tr> <tr><td>5V</td><td>+5V</td></tr> <tr><td>0V</td><td>0V</td></tr> </tbody> </table> <p>PT (RS232C)</p> <table border="1"> <thead> <tr> <th>Pin No.</th> <th>Signal</th> </tr> </thead> <tbody> <tr><td>1</td><td>+</td></tr> <tr><td>2</td><td>-</td></tr> <tr><td>3</td><td>FG</td></tr> <tr><td>4</td><td>SD</td></tr> <tr><td>5</td><td>RD</td></tr> <tr><td>6</td><td>NC</td></tr> <tr><td>7</td><td>NC</td></tr> <tr><td>8</td><td>SG</td></tr> </tbody> </table>	Pin No.	Signal	SD	SD	RD	RD	SG	SG	24V	+24V	5V	+5V	0V	0V	Pin No.	Signal	1	+	2	-	3	FG	4	SD	5	RD	6	NC	7	NC	8	SG	NV3W-V1, NV4W, or NV3Q for RS-232C
Pin No.	Signal																																	
SD	SD																																	
RD	RD																																	
SG	SG																																	
24V	+24V																																	
5V	+5V																																	
0V	0V																																	
Pin No.	Signal																																	
1	+																																	
2	-																																	
3	FG																																	
4	SD																																	
5	RD																																	
6	NC																																	
7	NC																																	
8	SG																																	

#### Connections between the FP7 COM0 port and the NV-series PT (5V/RS232C type)

PLC	Connection diagram	PT																																
FP7 Communications cable: Loose wires	<p>FP7 COM0 port</p> <table border="1"> <thead> <tr> <th>Pin No.</th> <th>Signal</th> </tr> </thead> <tbody> <tr><td>SD</td><td>SD</td></tr> <tr><td>RD</td><td>RD</td></tr> <tr><td>SG</td><td>SG</td></tr> <tr><td>24V</td><td>+24V</td></tr> <tr><td>5V</td><td>+5V</td></tr> <tr><td>0V</td><td>0V</td></tr> </tbody> </table> <p>PT (RS232C)</p> <table border="1"> <thead> <tr> <th>Pin No.</th> <th>Signal</th> </tr> </thead> <tbody> <tr><td>1</td><td>+</td></tr> <tr><td>2</td><td>-</td></tr> <tr><td>3</td><td>FG</td></tr> <tr><td>4</td><td>SD</td></tr> <tr><td>5</td><td>RD</td></tr> <tr><td>6</td><td>NC</td></tr> <tr><td>7</td><td>NC</td></tr> <tr><td>8</td><td>SG</td></tr> </tbody> </table>	Pin No.	Signal	SD	SD	RD	RD	SG	SG	24V	+24V	5V	+5V	0V	0V	Pin No.	Signal	1	+	2	-	3	FG	4	SD	5	RD	6	NC	7	NC	8	SG	NV3W-V1 for RS-232C
Pin No.	Signal																																	
SD	SD																																	
RD	RD																																	
SG	SG																																	
24V	+24V																																	
5V	+5V																																	
0V	0V																																	
Pin No.	Signal																																	
1	+																																	
2	-																																	
3	FG																																	
4	SD																																	
5	RD																																	
6	NC																																	
7	NC																																	
8	SG																																	

#### Connections between the FP7 communication cassette AFP7CCS1 (RS-232C 1ch insulated type) and the NV-series PT (RS232C type)

PLC	Connection diagram	PT																										
FP7 Communications cable: Loose wires	<p>To power supply</p> <p>FP7 AFP7CCS1</p> <table border="1"> <thead> <tr> <th>Pin No.</th> <th>Signal</th> </tr> </thead> <tbody> <tr><td>SD</td><td>SD</td></tr> <tr><td>RD</td><td>RD</td></tr> <tr><td>SG</td><td>SG</td></tr> </tbody> </table> <p>PT (RS232C)</p> <table border="1"> <thead> <tr> <th>Pin No.</th> <th>Signal</th> </tr> </thead> <tbody> <tr><td>1</td><td>+</td></tr> <tr><td>2</td><td>-</td></tr> <tr><td>3</td><td>FG</td></tr> <tr><td>4</td><td>SD</td></tr> <tr><td>5</td><td>RD</td></tr> <tr><td>6</td><td>NC</td></tr> <tr><td>7</td><td>NC</td></tr> <tr><td>8</td><td>SG</td></tr> </tbody> </table>	Pin No.	Signal	SD	SD	RD	RD	SG	SG	Pin No.	Signal	1	+	2	-	3	FG	4	SD	5	RD	6	NC	7	NC	8	SG	NV3W-V1, NV4W, or NV3Q for RS-232C
Pin No.	Signal																											
SD	SD																											
RD	RD																											
SG	SG																											
Pin No.	Signal																											
1	+																											
2	-																											
3	FG																											
4	SD																											
5	RD																											
6	NC																											
7	NC																											
8	SG																											

**Connections between the FP7 communication cassette AFP7CCS2 (RS-232C 2ch insulated type) and the NV-series PT (RS232C type)**

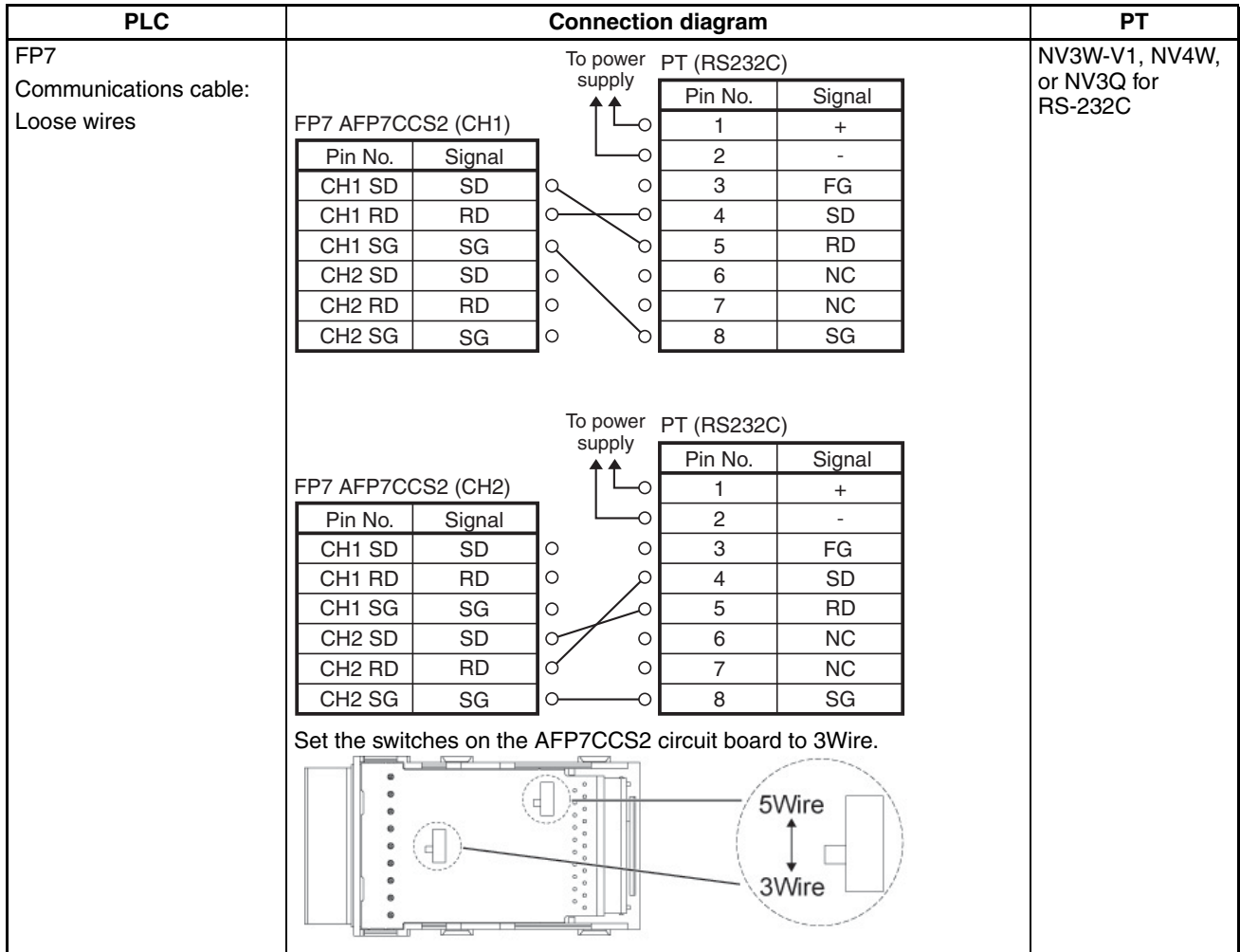

### 2-7-2 RS422 connections

Connections between the FP7 communication cassette AFP7CCM1 (RS-422 / RS-485 1ch insulated type) and the NV-series PT (RS-422 / RS-485 types) (the case of RS-422)

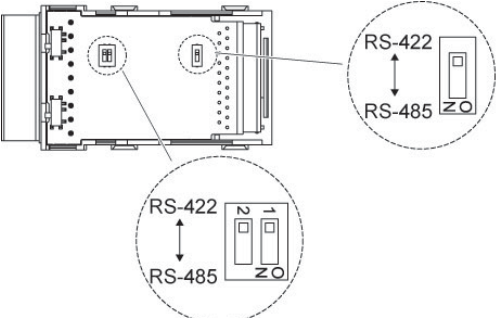
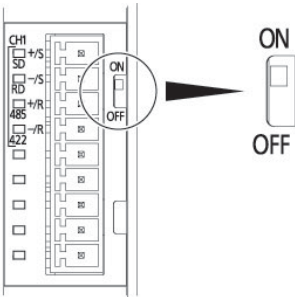
PLC	Connection diagram	PT																												
<p>FP7 Communications cable: Loose wires</p>	<div style="text-align: right; margin-bottom: 10px;">                     To power supply                      PT (RS-422A)                 </div> <table border="1" style="margin-bottom: 10px;"> <thead> <tr> <th>Pin No.</th> <th>Signal</th> </tr> </thead> <tbody> <tr><td>1</td><td>+</td></tr> <tr><td>2</td><td>-</td></tr> <tr><td>3</td><td>FG</td></tr> <tr><td>4</td><td>+SD</td></tr> <tr><td>5</td><td>-SD</td></tr> <tr><td>6</td><td>+RD</td></tr> <tr><td>7</td><td>-RD</td></tr> <tr><td>8</td><td>E</td></tr> </tbody> </table> <table border="1" style="margin-bottom: 10px;"> <thead> <tr> <th>Pin No.</th> <th>Signal</th> </tr> </thead> <tbody> <tr><td>+ / S</td><td>+SD</td></tr> <tr><td>- / S</td><td>-SD</td></tr> <tr><td>+ / R</td><td>+RD</td></tr> <tr><td>- / R</td><td>-RD</td></tr> </tbody> </table> <p>Set the switches on the AFP7CCM1 circuit board to RS-422.</p>  <p>In addition, set the internal terminator switch of AFP7CCM1 to ON.</p> 	Pin No.	Signal	1	+	2	-	3	FG	4	+SD	5	-SD	6	+RD	7	-RD	8	E	Pin No.	Signal	+ / S	+SD	- / S	-SD	+ / R	+RD	- / R	-RD	<p>NV3W-V1, NV4W, or NV3Q for RS-232C</p>
Pin No.	Signal																													
1	+																													
2	-																													
3	FG																													
4	+SD																													
5	-SD																													
6	+RD																													
7	-RD																													
8	E																													
Pin No.	Signal																													
+ / S	+SD																													
- / S	-SD																													
+ / R	+RD																													
- / R	-RD																													

**Connections between the FP7 communication cassette AFP7CCM2 (RS-422 / RS-485 2ch insulated type) and the NV-series PT (RS-422 / RS-485 types) (the case of RS-422)**

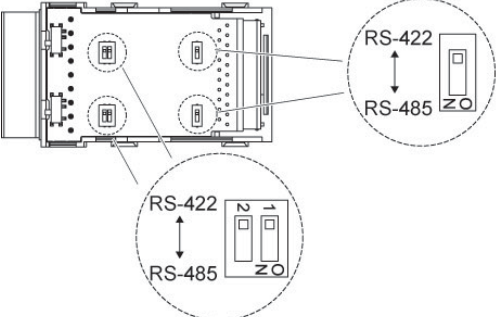
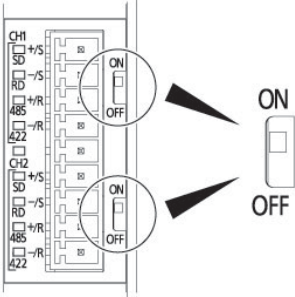
PLC	Connection diagram	PT																																																																												
FP7 Communications cable: Loose wires	<p>FP7 AFP7CCM2 (CH1)</p> <table border="1" data-bbox="464 300 724 615"> <thead> <tr> <th>Pin No.</th> <th>Signal</th> </tr> </thead> <tbody> <tr><td>CH1 + / S</td><td>+SD</td></tr> <tr><td>CH1 - / S</td><td>-SD</td></tr> <tr><td>CH1 + / R</td><td>+RD</td></tr> <tr><td>CH1 - / R</td><td>-RD</td></tr> <tr><td>-</td><td>-</td></tr> <tr><td>CH2 + / S</td><td>+SD</td></tr> <tr><td>CH2 - / S</td><td>-SD</td></tr> <tr><td>CH2 + / R</td><td>+RD</td></tr> <tr><td>CH2 - / R</td><td>-RD</td></tr> </tbody> </table> <p>To power supply</p> <table border="1" data-bbox="847 331 1107 615"> <thead> <tr> <th>Pin No.</th> <th>Signal</th> </tr> </thead> <tbody> <tr><td>1</td><td>+</td></tr> <tr><td>2</td><td>-</td></tr> <tr><td>3</td><td>FG</td></tr> <tr><td>4</td><td>+SD</td></tr> <tr><td>5</td><td>-SD</td></tr> <tr><td>6</td><td>+RD</td></tr> <tr><td>7</td><td>-RD</td></tr> <tr><td>8</td><td>E</td></tr> </tbody> </table> <p>PT (RS-422A)</p> <p>FP7 AFP7CCM2 (CH2)</p> <table border="1" data-bbox="464 688 724 1003"> <thead> <tr> <th>Pin No.</th> <th>Signal</th> </tr> </thead> <tbody> <tr><td>CH1 + / S</td><td>+SD</td></tr> <tr><td>CH1 - / S</td><td>-SD</td></tr> <tr><td>CH1 + / R</td><td>+RD</td></tr> <tr><td>CH1 - / R</td><td>-RD</td></tr> <tr><td>-</td><td>-</td></tr> <tr><td>CH2 + / S</td><td>+SD</td></tr> <tr><td>CH2 - / S</td><td>-SD</td></tr> <tr><td>CH2 + / R</td><td>+RD</td></tr> <tr><td>CH2 - / R</td><td>-RD</td></tr> </tbody> </table> <p>To power supply</p> <table border="1" data-bbox="847 720 1107 1003"> <thead> <tr> <th>Pin No.</th> <th>Signal</th> </tr> </thead> <tbody> <tr><td>1</td><td>+</td></tr> <tr><td>2</td><td>-</td></tr> <tr><td>3</td><td>FG</td></tr> <tr><td>4</td><td>+SD</td></tr> <tr><td>5</td><td>-SD</td></tr> <tr><td>6</td><td>+RD</td></tr> <tr><td>7</td><td>-RD</td></tr> <tr><td>8</td><td>E</td></tr> </tbody> </table> <p>PT (RS-422A)</p> <p>Set the switches on the AFP7CCM2 circuit board to RS-422.</p>  <p>In addition, set the internal terminator switches of AFP7CCM2 to ON.</p> 	Pin No.	Signal	CH1 + / S	+SD	CH1 - / S	-SD	CH1 + / R	+RD	CH1 - / R	-RD	-	-	CH2 + / S	+SD	CH2 - / S	-SD	CH2 + / R	+RD	CH2 - / R	-RD	Pin No.	Signal	1	+	2	-	3	FG	4	+SD	5	-SD	6	+RD	7	-RD	8	E	Pin No.	Signal	CH1 + / S	+SD	CH1 - / S	-SD	CH1 + / R	+RD	CH1 - / R	-RD	-	-	CH2 + / S	+SD	CH2 - / S	-SD	CH2 + / R	+RD	CH2 - / R	-RD	Pin No.	Signal	1	+	2	-	3	FG	4	+SD	5	-SD	6	+RD	7	-RD	8	E	NV3W-V1, NV4W, or NV3Q for RS-232C
Pin No.	Signal																																																																													
CH1 + / S	+SD																																																																													
CH1 - / S	-SD																																																																													
CH1 + / R	+RD																																																																													
CH1 - / R	-RD																																																																													
-	-																																																																													
CH2 + / S	+SD																																																																													
CH2 - / S	-SD																																																																													
CH2 + / R	+RD																																																																													
CH2 - / R	-RD																																																																													
Pin No.	Signal																																																																													
1	+																																																																													
2	-																																																																													
3	FG																																																																													
4	+SD																																																																													
5	-SD																																																																													
6	+RD																																																																													
7	-RD																																																																													
8	E																																																																													
Pin No.	Signal																																																																													
CH1 + / S	+SD																																																																													
CH1 - / S	-SD																																																																													
CH1 + / R	+RD																																																																													
CH1 - / R	-RD																																																																													
-	-																																																																													
CH2 + / S	+SD																																																																													
CH2 - / S	-SD																																																																													
CH2 + / R	+RD																																																																													
CH2 - / R	-RD																																																																													
Pin No.	Signal																																																																													
1	+																																																																													
2	-																																																																													
3	FG																																																																													
4	+SD																																																																													
5	-SD																																																																													
6	+RD																																																																													
7	-RD																																																																													
8	E																																																																													

### 2-7-3 RS-485 connections

Connections between the FP7 communication cassette AFP7CCM1 (RS-422 / RS-485 1ch insulated type) and the NV-series PT (RS-422 / RS-485 types) (the case of RS-485)

- 1:1 connections

PLC	Connection diagram	PT																												
<p>FP7 Communications cable: Loose wires</p>	<div style="text-align: center;"> <p>To power supply</p> </div> <div style="display: flex; justify-content: space-around; margin-top: 10px;"> <table border="1" style="border-collapse: collapse;"> <thead> <tr> <th>Pin No.</th> <th>Signal</th> </tr> </thead> <tbody> <tr><td>+ / S</td><td>+</td></tr> <tr><td>- / S</td><td>-</td></tr> <tr><td>+ / R</td><td>+</td></tr> <tr><td>- / R</td><td>-</td></tr> </tbody> </table> <table border="1" style="border-collapse: collapse;"> <thead> <tr> <th>Pin No.</th> <th>Signal</th> </tr> </thead> <tbody> <tr><td>1</td><td>+</td></tr> <tr><td>2</td><td>-</td></tr> <tr><td>3</td><td>FG</td></tr> <tr><td>4</td><td>+SD</td></tr> <tr><td>5</td><td>-SD</td></tr> <tr><td>6</td><td>+RD</td></tr> <tr><td>7</td><td>-RD</td></tr> <tr><td>8</td><td>E</td></tr> </tbody> </table> </div> <p style="margin-top: 20px;">Set the switches on the AFP7CCM1 circuit board to RS-485.</p> <p style="margin-top: 20px;">In addition, set the internal terminator switch of AFP7CCM1 to ON.</p>	Pin No.	Signal	+ / S	+	- / S	-	+ / R	+	- / R	-	Pin No.	Signal	1	+	2	-	3	FG	4	+SD	5	-SD	6	+RD	7	-RD	8	E	<p>NV3W-V1, NV4W, or NV3Q for RS-232C</p>
Pin No.	Signal																													
+ / S	+																													
- / S	-																													
+ / R	+																													
- / R	-																													
Pin No.	Signal																													
1	+																													
2	-																													
3	FG																													
4	+SD																													
5	-SD																													
6	+RD																													
7	-RD																													
8	E																													

• Connections to more than one PLC

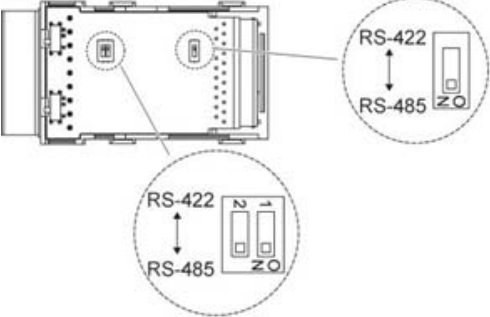
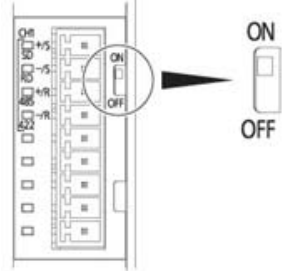
PLC	Connection diagram	PT																																						
<p>FP7</p> <p>Communications cable: Loose wires</p>	<div style="display: flex; justify-content: space-around;"> <table border="1" data-bbox="459 338 643 470"> <caption>FP7 AFP7CCM1 (end)</caption> <thead> <tr><th>Pin No.</th><th>Signal</th></tr> </thead> <tbody> <tr><td>+ / S</td><td>+</td></tr> <tr><td>- / S</td><td>-</td></tr> <tr><td>+ / R</td><td>+</td></tr> <tr><td>- / R</td><td>-</td></tr> </tbody> </table> <table border="1" data-bbox="730 338 914 470"> <caption>FP7</caption> <thead> <tr><th>Pin No.</th><th>Signal</th></tr> </thead> <tbody> <tr><td>+ / S</td><td>+</td></tr> <tr><td>- / S</td><td>-</td></tr> <tr><td>+ / R</td><td>+</td></tr> <tr><td>- / R</td><td>-</td></tr> </tbody> </table> <table border="1" data-bbox="1002 268 1185 470"> <caption>PT (RS-485)</caption> <thead> <tr><th>Pin No.</th><th>Signal</th></tr> </thead> <tbody> <tr><td>1</td><td>+</td></tr> <tr><td>2</td><td>-</td></tr> <tr><td>3</td><td>FG</td></tr> <tr><td>4</td><td>+SD</td></tr> <tr><td>5</td><td>-SD</td></tr> <tr><td>6</td><td>+RD</td></tr> <tr><td>7</td><td>-RD</td></tr> <tr><td>8</td><td>E</td></tr> </tbody> </table> </div> <p data-bbox="459 478 592 512">Internal terminator switch: ON</p> <p data-bbox="730 478 863 512">Internal terminator switch: OFF</p> <p data-bbox="459 615 1091 642">Set the switches on the AFP7CCM1 circuit board to RS-485.</p>  <p data-bbox="459 1020 1166 1073">In addition, set to ON the internal terminator switch of either FP7 or AFP7CCM1 as the terminal device.</p> 	Pin No.	Signal	+ / S	+	- / S	-	+ / R	+	- / R	-	Pin No.	Signal	+ / S	+	- / S	-	+ / R	+	- / R	-	Pin No.	Signal	1	+	2	-	3	FG	4	+SD	5	-SD	6	+RD	7	-RD	8	E	<p>NV3W-V1, NV4W, or NV3Q for RS-232C</p>
Pin No.	Signal																																							
+ / S	+																																							
- / S	-																																							
+ / R	+																																							
- / R	-																																							
Pin No.	Signal																																							
+ / S	+																																							
- / S	-																																							
+ / R	+																																							
- / R	-																																							
Pin No.	Signal																																							
1	+																																							
2	-																																							
3	FG																																							
4	+SD																																							
5	-SD																																							
6	+RD																																							
7	-RD																																							
8	E																																							

**Connections between the FP7 communication cassette AFP7CCM2 (RS-422 / RS-485 2ch insulated type) and the NV-series PT (RS-422 / RS-485 types) (the case of RS-485)**

- 1:1 connections

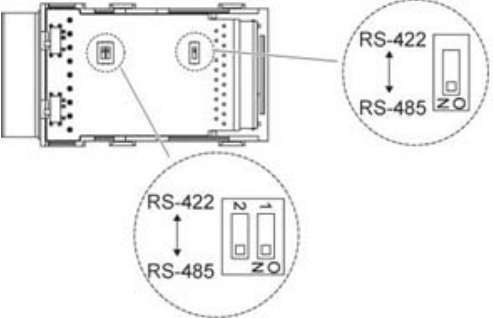
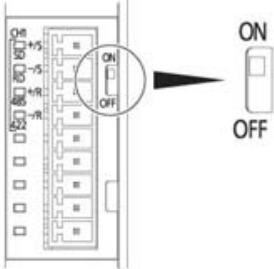
PLC	Connection diagram	PT																																																																												
<p>FP7</p> <p>Communications cable: Loose wires</p>	<p>FP7 AFP7CCM2 (CH1)</p> <table border="1" data-bbox="464 342 724 657"> <thead> <tr> <th>Pin No.</th> <th>Signal</th> </tr> </thead> <tbody> <tr><td>CH1 + / S</td><td>+</td></tr> <tr><td>CH1 - / S</td><td>-</td></tr> <tr><td>CH1 + / R</td><td>+</td></tr> <tr><td>CH1 - / R</td><td>-</td></tr> <tr><td>-</td><td>NC</td></tr> <tr><td>CH2 + / S</td><td>+</td></tr> <tr><td>CH2 - / S</td><td>-</td></tr> <tr><td>CH2 + / R</td><td>+</td></tr> <tr><td>CH2 - / R</td><td>-</td></tr> </tbody> </table> <p>To power supply</p> <table border="1" data-bbox="847 373 1107 657"> <thead> <tr> <th>Pin No.</th> <th>Signal</th> </tr> </thead> <tbody> <tr><td>1</td><td>+</td></tr> <tr><td>2</td><td>-</td></tr> <tr><td>3</td><td>FG</td></tr> <tr><td>4</td><td>+SD</td></tr> <tr><td>5</td><td>-SD</td></tr> <tr><td>6</td><td>+RD</td></tr> <tr><td>7</td><td>-RD</td></tr> <tr><td>8</td><td>E</td></tr> </tbody> </table> <p>PT (RS-485)</p> <p>FP7 AFP7CCM2 (CH2)</p> <table border="1" data-bbox="464 730 724 1045"> <thead> <tr> <th>Pin No.</th> <th>Signal</th> </tr> </thead> <tbody> <tr><td>CH1 + / S</td><td>+</td></tr> <tr><td>CH1 - / S</td><td>-</td></tr> <tr><td>CH1 + / R</td><td>+</td></tr> <tr><td>CH1 - / R</td><td>-</td></tr> <tr><td>-</td><td>NC</td></tr> <tr><td>CH2 + / S</td><td>+</td></tr> <tr><td>CH2 - / S</td><td>-</td></tr> <tr><td>CH2 + / R</td><td>+</td></tr> <tr><td>CH2 - / R</td><td>-</td></tr> </tbody> </table> <p>To power supply</p> <table border="1" data-bbox="847 762 1107 1045"> <thead> <tr> <th>Pin No.</th> <th>Signal</th> </tr> </thead> <tbody> <tr><td>1</td><td>+</td></tr> <tr><td>2</td><td>-</td></tr> <tr><td>3</td><td>FG</td></tr> <tr><td>4</td><td>+SD</td></tr> <tr><td>5</td><td>-SD</td></tr> <tr><td>6</td><td>+RD</td></tr> <tr><td>7</td><td>-RD</td></tr> <tr><td>8</td><td>E</td></tr> </tbody> </table> <p>PT (RS-485)</p> <p>Set the switches on the AFP7CCM2 circuit board to RS-485.</p>  <p>In addition, set the internal terminator switch of AFP7CCM2 to ON.</p> 	Pin No.	Signal	CH1 + / S	+	CH1 - / S	-	CH1 + / R	+	CH1 - / R	-	-	NC	CH2 + / S	+	CH2 - / S	-	CH2 + / R	+	CH2 - / R	-	Pin No.	Signal	1	+	2	-	3	FG	4	+SD	5	-SD	6	+RD	7	-RD	8	E	Pin No.	Signal	CH1 + / S	+	CH1 - / S	-	CH1 + / R	+	CH1 - / R	-	-	NC	CH2 + / S	+	CH2 - / S	-	CH2 + / R	+	CH2 - / R	-	Pin No.	Signal	1	+	2	-	3	FG	4	+SD	5	-SD	6	+RD	7	-RD	8	E	<p>NV3W-V1, NV4W, or NV3Q for RS-232C</p>
Pin No.	Signal																																																																													
CH1 + / S	+																																																																													
CH1 - / S	-																																																																													
CH1 + / R	+																																																																													
CH1 - / R	-																																																																													
-	NC																																																																													
CH2 + / S	+																																																																													
CH2 - / S	-																																																																													
CH2 + / R	+																																																																													
CH2 - / R	-																																																																													
Pin No.	Signal																																																																													
1	+																																																																													
2	-																																																																													
3	FG																																																																													
4	+SD																																																																													
5	-SD																																																																													
6	+RD																																																																													
7	-RD																																																																													
8	E																																																																													
Pin No.	Signal																																																																													
CH1 + / S	+																																																																													
CH1 - / S	-																																																																													
CH1 + / R	+																																																																													
CH1 - / R	-																																																																													
-	NC																																																																													
CH2 + / S	+																																																																													
CH2 - / S	-																																																																													
CH2 + / R	+																																																																													
CH2 - / R	-																																																																													
Pin No.	Signal																																																																													
1	+																																																																													
2	-																																																																													
3	FG																																																																													
4	+SD																																																																													
5	-SD																																																																													
6	+RD																																																																													
7	-RD																																																																													
8	E																																																																													



• Connections to more than one PLC

Refer to the "Connections between the FP7 communication cassette AFP7CCM1 (RS-422 / RS-485 1ch insulated type) and the NV-series PT (RS-422 / RS-485 types) (the case of RS-485)" previous subsection to perform connections.

### 2-7-4 Clock Settings

To use a Panasonic FP7 series device, the reference format of the PLC internal clock is different from the one for the Panasonic FP series devices. The NV series PTs, however, support both formats, and thus you can select the applicable one.

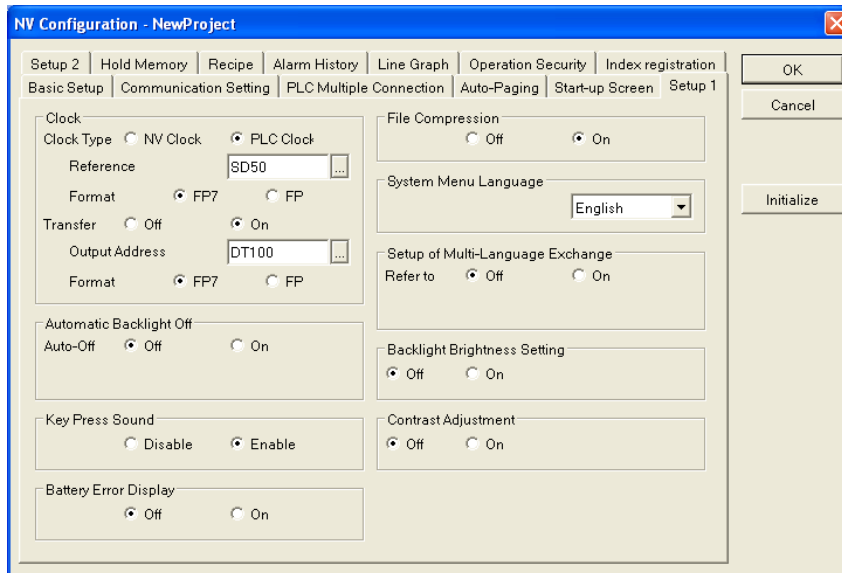

On the Setup 1 tab from the Configuration menu, specify the [Clock] - [Format] and [Transfer Outside] - [Format] parameters. For FP7 the clock data have been stored in SD50 to SD56. To access the FP7 internal clock, set [Reference address] to SD50.

PLC address storing internal clock data and their formats

Panasonic FP series		Panasonic FP7 series	
Access address number	Data format (Hex)	Access address number	Data format (binary)
DT90054 (DT9054)	Upper byte: Minutes (H00 to H59) Lower byte: Seconds (H00 to H59)	SD50	Year (Lower 2 digits: U1 to U99)
DT90055 (DT9055)	Upper byte: Date (H01 to H31) Lower byte: Hour (H00 to H23)	SD51	Month (U1 to U12)
DT90056 (DT9056)	Upper byte: Year (H01 to H99) Lower byte: Month (H01 to H12)	SD52	Date (U1 to U31)

Panasonic FP series		Panasonic FP7 series	
Access address number	Data format (Hex)	Access address number	Data format (binary)
DT90057 (DT9057)	Upper byte: None Lower byte: Day of week (H00 to H06)	SD53	Hour (U0 to U23)
		SD54	Minutes (U0 to U59)
		SD55	Seconds (U0 to U59)
		SD56	Day of week (U0 to U6)



**Additional Information**

While the FP7 clock data are stored in SD50 to SD56, no value can be written in these areas. Thus, the FP7 internal clock data cannot be modified even if using the option to transfer clock data to an external device. Output the data to the data register using the option and then execute the TIMEWT command to update the FP7 internal clock data.

# SECTION 3

## Connecting to Toshiba Machine PLCs

3-1	PROVISER TCmini Series .....	46
3-1-1	RS-232C Connections .....	47
3-1-2	RS-485 Connections .....	48

### 3-1 PROVISER TCmini Series

**PLC Model Selection**                      Select Toshiba Machine PROVISER TCmini Series.

**Applicable Devices**

Bit/word devices		No.	Comments
Bit devices	Input devices	X 0000 to X 0F7F	
	Output devices	Y 0000 to Y 0F7F	
	Auxiliary relay devices	R 0000 to R 077F	
	Timer relay devices	T 0000 to T 077F	
	Counter relay devices	C 0000 to C 077F	
	Link relay devices	L 0000 to L 007F	
	Edge relay devices	E 0000 to E 077F	
	Special auxiliary relay devices	A 0000 to A 016F	
Word devices	Input devices	X 0000W to X 00F7W	
	Output devices	Y 0000W to Y 00F7W	
	Auxiliary relay devices	R 0000W to R 0077W	
	Timer relay devices	T 0000W to T 0077W	
	Counter relay devices	C 0000W to C 0077W	
	Link relay devices	L 0000W to L 0007W	
	Edge relay devices	E 0000W to E 0077W	
	Special auxiliary relay devices	A 0000W to A 0016W	
	Data registers	D 0000 to D 0F7F	
	Timer/counter current values	P 0000 to P 077F	
	Timer/counter set values	V 0000 to V 077F	

Use the following notation from the NV-Designer for PLC devices. Use the NV-Designer notation when entering devices.

	PLC notation	NV-Designer notation
Bit devices	R120	R120
Word devices	R12W	RW12
	X12W	XW12
	Y12W	YW12

**Communications Settings** The following communications settings are recommended for the PT and PLC.

■ **PT Communications Settings (Set from the NV-Designer using the NV Configuration.)**

Item	Setting
Baud rate	19,200 bps
Data length	8
Stop bits	1
Parity	None

■ **PLC Communications Settings**

	Setting
RS-232C Connections	No settings are required.
RS-485 Connections	Set the communications mode to the host communications protocol connection mode. <b>Note</b> Refer to the user manual for the TCmini for the setting procedure.

### 3-1-1 RS-232C Connections

**Connection Diagram**

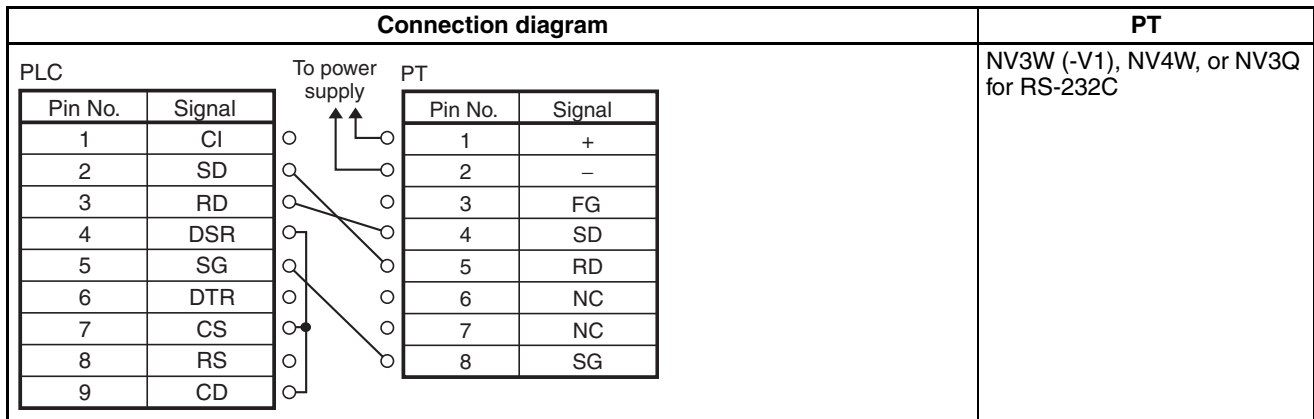

### 3-1-2 RS-485 Connections

Connection Diagram for 7-pin Connector on PLC

Connection diagram		PT																																		
<p>PLC</p> <table border="1"> <thead> <tr> <th>Pin No.</th> <th>Signal</th> </tr> </thead> <tbody> <tr><td>1</td><td>TxD+</td></tr> <tr><td>2</td><td>TxD-</td></tr> <tr><td>3</td><td>RxD+</td></tr> <tr><td>4</td><td>RxD-</td></tr> <tr><td>5</td><td>GND</td></tr> <tr><td>6</td><td>P5V</td></tr> <tr><td>7</td><td>FG</td></tr> </tbody> </table>	Pin No.	Signal	1	TxD+	2	TxD-	3	RxD+	4	RxD-	5	GND	6	P5V	7	FG	<p>PT</p> <table border="1"> <thead> <tr> <th>Pin No.</th> <th>Signal</th> </tr> </thead> <tbody> <tr><td>1</td><td>+</td></tr> <tr><td>2</td><td>-</td></tr> <tr><td>3</td><td>FG</td></tr> <tr><td>4</td><td>+SD</td></tr> <tr><td>5</td><td>-SD</td></tr> <tr><td>6</td><td>+RD</td></tr> <tr><td>7</td><td>-RD</td></tr> <tr><td>8</td><td>E</td></tr> </tbody> </table>	Pin No.	Signal	1	+	2	-	3	FG	4	+SD	5	-SD	6	+RD	7	-RD	8	E	<p>NV3W (-V1), NV4W, or NV3Q for RS-485</p>
Pin No.	Signal																																			
1	TxD+																																			
2	TxD-																																			
3	RxD+																																			
4	RxD-																																			
5	GND																																			
6	P5V																																			
7	FG																																			
Pin No.	Signal																																			
1	+																																			
2	-																																			
3	FG																																			
4	+SD																																			
5	-SD																																			
6	+RD																																			
7	-RD																																			
8	E																																			

Connection Diagram for 8-pin Connector on PLC

Connection diagram		PT																																				
<p>PLC</p> <table border="1"> <thead> <tr> <th>Pin No.</th> <th>Signal</th> </tr> </thead> <tbody> <tr><td>1</td><td>TxD+</td></tr> <tr><td>2</td><td>TxD-</td></tr> <tr><td>3</td><td>RxD+</td></tr> <tr><td>4</td><td>RxD-</td></tr> <tr><td>5</td><td>GND</td></tr> <tr><td>6</td><td>P5V</td></tr> <tr><td>7</td><td>NC</td></tr> <tr><td>8</td><td>FG</td></tr> </tbody> </table>	Pin No.	Signal	1	TxD+	2	TxD-	3	RxD+	4	RxD-	5	GND	6	P5V	7	NC	8	FG	<p>PT</p> <table border="1"> <thead> <tr> <th>Pin No.</th> <th>Signal</th> </tr> </thead> <tbody> <tr><td>1</td><td>+</td></tr> <tr><td>2</td><td>-</td></tr> <tr><td>3</td><td>FG</td></tr> <tr><td>4</td><td>+SD</td></tr> <tr><td>5</td><td>-SD</td></tr> <tr><td>6</td><td>+RD</td></tr> <tr><td>7</td><td>-RD</td></tr> <tr><td>8</td><td>E</td></tr> </tbody> </table>	Pin No.	Signal	1	+	2	-	3	FG	4	+SD	5	-SD	6	+RD	7	-RD	8	E	<p>NV3W (-V1), NV4W, or NV3Q for RS-485</p>
Pin No.	Signal																																					
1	TxD+																																					
2	TxD-																																					
3	RxD+																																					
4	RxD-																																					
5	GND																																					
6	P5V																																					
7	NC																																					
8	FG																																					
Pin No.	Signal																																					
1	+																																					
2	-																																					
3	FG																																					
4	+SD																																					
5	-SD																																					
6	+RD																																					
7	-RD																																					
8	E																																					

# SECTION 4

## Connecting to Allen-Bradley PLCs

4-1	SLC500 Micro Logix Series . . . . .	50
4-1-1	SLC500 Series (Use Link Interface on CPU Unit) . . . . .	52
4-1-2	MicroLogix 1000 . . . . .	52

# 4-1 SLC500 Micro Logix Series

PLC Model Selection Set Allen-Bradley SLC500 Micro Logix Series.

## Applicable Devices

Bit/word devices		No.	Comments
Bit devices	Binary	B 3:0/0 to B 255:255/15	
	Inputs	I 0.0/0 to I : 30.255/15	
	Outputs	O 0.0/0 to O : 30.255/15	
	Status	S 0/0 to S 164/15	
	Timer enabled bits	T/EN 3:0 to T/EN 255:255	
	Timer timing bits	T/TT 3:0 to T/TT 255:255	
	Timer done bits	T/DN 3:0 to T/DN 255:255	
	Counter count up enabled bits	C/CU 3:0 to C/CU 255:255	
	Counter count down enabled bits	C/CD 3:0 to C/CD 255:255	
	Counter done bits	C/DN 3:0 to C/DN 255:255	
	Counter overflow bits	C/OV 3:0 to C/OVCU 255:255	
	Counter underflow bits	C/UN 3:0 to C/UN 255:255	
	Counter update accumulator bits	C/UA 3:0 to C/UA 255:255	
	Integers	N 7:0 to N 255:255/15	
	Control enabled bits	R/EN 6:0 to R/EN 255:255	
	Control unload enabled bits	R/EU 6:0 to R/EU 255:255	
	Control done bits	R/DN 6:0 to R/DN 255:255	
	Control stack empty bits	R/EM 6:0 to R/EM 255:255	
	Control error bits	R/ER 6:0 to R/ER 255:255	
	Control unload bits	R/UL 6:0 to R/UL 255:255	
Control inhibit comparisons bits	R/IN 6:0 to R/IN 255:255		
Control found bits	R/FD 6:0 to R/FD 255:255		
Word devices	Binary	B 3:0 to B 255:255	
	Inputs	I: 0.0 to I: 30.255	
	Outputs	O: 0.0 to O: 30.255	
	Status	S O to S 164	
	Timer preset values	T.ACC 3:0 to T.ACC 255:255	
	Timer accumulated values	T.PRE 3:0 to T.PRE 255:255	
	Counter preset values	C.ACC 3:0 to C.ACC 255:255	
	Counter accumulated values	C.PER 7:0 to C.PER 255:255	
	Integers	N 7:0 to N 255:255	
	ASCII	A 8.0 to A 255:255	
	Control position	R.POS 6:0 to C.POS 255:255	
	Control length	R.LEN 6:0 to R.LEN 255:255	
	Double-word devices	Floating-point elements	F 8:0 to F 255:255
Long words (2-word integers)		L 9:0 to C.PER 255:255	
Character string devices	ASCII strings	ST 9:0 to ST 255:255	

**Note** Restrictions on Character String Devices

- ASCII strings (ST character string devices) can be used only as character strings. To access an ASCII string, set the data format of the data part to ASCII.
- To write an ASCII string from the PT, set the number of characters in sub-element 0 from the PLC.



- When setting the data format of a data part to ASCII and three or more display digits are specified, the maximum value that can be displayed for the element number is limited.
- Set the data access priority in the attribute options for an ASCII data format for a data part to lower to upper for the address and upper byte to lower byte for the word.

Use the following notation from the NV-Designer for PLC devices. Use the NV-Designer notation when entering devices.

	PLC notation	PT notation
Bit devices	<p>T 4 : 0 / EN</p> <p>Bit number Element File number File type</p>	<p>T / EN 4 : 0</p> <p>Element File number Bit number File type</p>
Word devices	<p>T 4 : 0 . Acc</p> <p>Sub-element number Element File number File type</p>	<p>T . Acc 4 : 0</p> <p>Element File number Sub-element number File type</p>

**Communications Settings**

The following communications settings are recommended for the PT and PLC.

■ **PT Communications Settings (Set from the NV-Designer using the NV Configuration.)**

Item	Setting
PT station number	01
PLC station number	00
Baud rate	19,200 bps
Data bits	8
Stop bits	1
Parity	None

■ **PLC Communications Settings**

Item	Setting
Baud Rate	19,200 bps
Parity	None
Stop Bits	1
Data Bits	8
Communication Driver	DF1 Full Duplex
Control Line	No Handshaking
Error Detection	CRC
Embedded Responses	Enabled
Duplicate Packet Detect	Enable

### 4-1-1 SLC500 Series (Use Link Interface on CPU Unit)

#### Connection Diagram

CPU	Connection diagram	PT																																						
SLC-5/03 SLC-5/04	<p>D-sub 9-pin connector on SLC500</p> <table border="1"> <thead> <tr> <th>Pin No.</th> <th>Signal</th> </tr> </thead> <tbody> <tr><td>1</td><td>CD</td></tr> <tr><td>2</td><td>RD</td></tr> <tr><td>3</td><td>SD</td></tr> <tr><td>4</td><td>ER</td></tr> <tr><td>5</td><td>SG</td></tr> <tr><td>6</td><td>DR</td></tr> <tr><td>7</td><td>RS</td></tr> <tr><td>8</td><td>CS</td></tr> <tr><td>9</td><td></td></tr> </tbody> </table> <p>To power supply</p> <table border="1"> <thead> <tr> <th>Pin No.</th> <th>Signal</th> </tr> </thead> <tbody> <tr><td>1</td><td>+</td></tr> <tr><td>2</td><td>-</td></tr> <tr><td>3</td><td>FG</td></tr> <tr><td>4</td><td>SD</td></tr> <tr><td>5</td><td>RD</td></tr> <tr><td>6</td><td>NC</td></tr> <tr><td>7</td><td>NC</td></tr> <tr><td>8</td><td>SG</td></tr> </tbody> </table>	Pin No.	Signal	1	CD	2	RD	3	SD	4	ER	5	SG	6	DR	7	RS	8	CS	9		Pin No.	Signal	1	+	2	-	3	FG	4	SD	5	RD	6	NC	7	NC	8	SG	NV3W (-V1), NV4W, or NV3Q for RS-232C
Pin No.	Signal																																							
1	CD																																							
2	RD																																							
3	SD																																							
4	ER																																							
5	SG																																							
6	DR																																							
7	RS																																							
8	CS																																							
9																																								
Pin No.	Signal																																							
1	+																																							
2	-																																							
3	FG																																							
4	SD																																							
5	RD																																							
6	NC																																							
7	NC																																							
8	SG																																							

### 4-1-2 MicroLogix 1000

#### Connection Configuration between PLC and PT

As shown below, connect the MicroLogix 1000 to a PC-to-MicroLogix Communications Cable and then connect the cable and the PT as shown below.

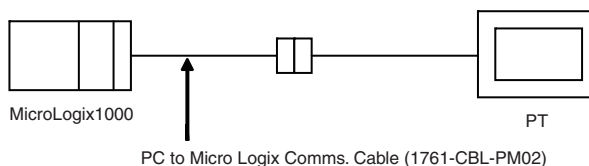

#### Connection Diagram

CPU	Connection diagram	PT																																						
MicroLogix1000	<p>Tool port connecting cable (9-pin connector)</p> <table border="1"> <thead> <tr> <th>Pin No.</th> <th>Signal</th> </tr> </thead> <tbody> <tr><td>1</td><td></td></tr> <tr><td>2</td><td>SD</td></tr> <tr><td>3</td><td>RD</td></tr> <tr><td>4</td><td></td></tr> <tr><td>5</td><td>SG</td></tr> <tr><td>6</td><td></td></tr> <tr><td>7</td><td></td></tr> <tr><td>8</td><td></td></tr> <tr><td>9</td><td></td></tr> </tbody> </table> <p>To power supply</p> <table border="1"> <thead> <tr> <th>Pin No.</th> <th>Signal</th> </tr> </thead> <tbody> <tr><td>1</td><td>+</td></tr> <tr><td>2</td><td>-</td></tr> <tr><td>3</td><td>FG</td></tr> <tr><td>4</td><td>SD</td></tr> <tr><td>5</td><td>RD</td></tr> <tr><td>6</td><td>NC</td></tr> <tr><td>7</td><td>NC</td></tr> <tr><td>8</td><td>SG</td></tr> </tbody> </table>	Pin No.	Signal	1		2	SD	3	RD	4		5	SG	6		7		8		9		Pin No.	Signal	1	+	2	-	3	FG	4	SD	5	RD	6	NC	7	NC	8	SG	NV3W (-V1), NV4W, or NV3Q for RS-232C
Pin No.	Signal																																							
1																																								
2	SD																																							
3	RD																																							
4																																								
5	SG																																							
6																																								
7																																								
8																																								
9																																								
Pin No.	Signal																																							
1	+																																							
2	-																																							
3	FG																																							
4	SD																																							
5	RD																																							
6	NC																																							
7	NC																																							
8	SG																																							

# SECTION 5

## Connecting to Siemens PLCs

- 5-1 S7-200 Series ..... 54
  - 5-1-1 RS-232C Connections ..... 55
  - 5-1-2 RS-485 Connections ..... 55

## 5-1 S7-200 Series

**PLC Model Selection**      Select Siemens S7-200 Series.

### Applicable Devices

Bit/word devices		No.	Comments
Bit devices	Inputs	I 00 to I 77	
	Outputs	Q 00 to Q 77	
	Bit memory	M 00 to M 317	
	Timer contacts	T 00 to T 255	
	Counter contacts	C 00 to C 255	
	Special memory	SM 00 to SM 1947	
	Sequence control relays	S 00 to S 317	
Word devices	Inputs	IW 0 to IW 6	Only even addresses can be set.
	Outputs	QW 0 to QW 6	Only even addresses can be set.
	Bit memory	MW 0 to MW 30	Only even addresses can be set.
	Timer current values	T 0 to T 255	Only even addresses can be set.
	Counter current values	C 0 to C 255	Only even addresses can be set.
	Special memory	SMW 0 to SMW 193	Only even addresses can be set.
	Sequence control relays	SW 0 to SW 30	Only even addresses can be set.
	Variable memory	VW 0 to VW 5118	Only even addresses can be set.

\*1 Use the following notation from the NV-Designer for PLC devices. Use the NV-Designer notation when entering devices.

	PLC notation	NV-Designer notation
Bit devices	Q3.2	Q3-2
Word devices	VW100	VW100

**Communications Settings**      The following communications settings are recommended for the PT and PLC.

#### ■ PT Communications Settings

Item	Setting
PT station number	01
PLC station number	02
Baud rate	9,600 bps
Data bits	8
Stop bits	1
Parity	Even

#### ■ PLC Communications Settings

Item	Setting
PLC station number	02

### 5-1-1 RS-232C Connections

**Connection Configuration between PLC and PT**

For an RS-232C connection, connect the S7-200 PC/PPI Cable and then connect the cable and the PT as shown below.

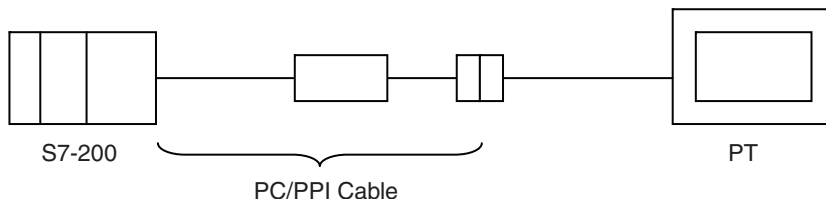

**Connection Diagram**

CPU	Connection diagram	PT																																						
CPU212 CPU214 CPU215 CPU216 CPU222 Cable: PC/PPI Cable	<p>PC/PPI Cable (9-pin connector)</p> <table border="1"> <thead> <tr> <th>Pin No.</th> <th>Signal</th> </tr> </thead> <tbody> <tr><td>1</td><td></td></tr> <tr><td>2</td><td>SD</td></tr> <tr><td>3</td><td>RD</td></tr> <tr><td>4</td><td></td></tr> <tr><td>5</td><td>SG</td></tr> <tr><td>6</td><td></td></tr> <tr><td>7</td><td>RS</td></tr> <tr><td>8</td><td>CS</td></tr> <tr><td>9</td><td></td></tr> </tbody> </table> <p>To power supply</p> <p>PT</p> <table border="1"> <thead> <tr> <th>Pin No.</th> <th>Signal</th> </tr> </thead> <tbody> <tr><td>1</td><td>+</td></tr> <tr><td>2</td><td>-</td></tr> <tr><td>3</td><td>FG</td></tr> <tr><td>4</td><td>SD</td></tr> <tr><td>5</td><td>RD</td></tr> <tr><td>6</td><td>NC</td></tr> <tr><td>7</td><td>NC</td></tr> <tr><td>8</td><td>SG</td></tr> </tbody> </table>	Pin No.	Signal	1		2	SD	3	RD	4		5	SG	6		7	RS	8	CS	9		Pin No.	Signal	1	+	2	-	3	FG	4	SD	5	RD	6	NC	7	NC	8	SG	NV3W (-V1), NV4W, or NV3Q for RS-232C
Pin No.	Signal																																							
1																																								
2	SD																																							
3	RD																																							
4																																								
5	SG																																							
6																																								
7	RS																																							
8	CS																																							
9																																								
Pin No.	Signal																																							
1	+																																							
2	-																																							
3	FG																																							
4	SD																																							
5	RD																																							
6	NC																																							
7	NC																																							
8	SG																																							

### 5-1-2 RS-485 Connections

**Connection Diagram**

CPU	Connection diagram	PT																																						
CPU212 CPU214 CPU215 CPU216 CPU222	<p>PLC</p> <table border="1"> <thead> <tr> <th>Pin No.</th> <th>Signal</th> </tr> </thead> <tbody> <tr><td>1</td><td>FG</td></tr> <tr><td>2</td><td>SG</td></tr> <tr><td>3</td><td>RxD/TxD+</td></tr> <tr><td>4</td><td>RS(TTL)</td></tr> <tr><td>5</td><td>SG</td></tr> <tr><td>6</td><td>+5V</td></tr> <tr><td>7</td><td>+24V</td></tr> <tr><td>8</td><td>RxD/TxD-</td></tr> <tr><td>9</td><td>N.C.</td></tr> </tbody> </table> <p>To power supply</p> <p>PT</p> <table border="1"> <thead> <tr> <th>Pin No.</th> <th>Signal</th> </tr> </thead> <tbody> <tr><td>1</td><td>+</td></tr> <tr><td>2</td><td>-</td></tr> <tr><td>3</td><td>FG</td></tr> <tr><td>4</td><td>+SD</td></tr> <tr><td>5</td><td>-SD</td></tr> <tr><td>6</td><td>+RD</td></tr> <tr><td>7</td><td>-RD</td></tr> <tr><td>8</td><td>E</td></tr> </tbody> </table>	Pin No.	Signal	1	FG	2	SG	3	RxD/TxD+	4	RS(TTL)	5	SG	6	+5V	7	+24V	8	RxD/TxD-	9	N.C.	Pin No.	Signal	1	+	2	-	3	FG	4	+SD	5	-SD	6	+RD	7	-RD	8	E	NV3W (-V1), NV4W, or NV3Q for RS-485
Pin No.	Signal																																							
1	FG																																							
2	SG																																							
3	RxD/TxD+																																							
4	RS(TTL)																																							
5	SG																																							
6	+5V																																							
7	+24V																																							
8	RxD/TxD-																																							
9	N.C.																																							
Pin No.	Signal																																							
1	+																																							
2	-																																							
3	FG																																							
4	+SD																																							
5	-SD																																							
6	+RD																																							
7	-RD																																							
8	E																																							



# SECTION 6

## Connecting to LG PLCs

6-1	MASKER-K (Cnet) Series .....	58
6-1-1	Connection Method .....	58

# 6-1 MASKER-K (Cnet) Series

**PLC Model Selection**      Select LG MASTER-K (Cnet) Series.

## Applicable Devices

Bit/word devices		No.	Comments
Bit devices	I/O relays	P 0000 to P 063F	
	Auxiliary relays	M 000 to M 191F	
Word devices	I/O relays	PW 0000 to PW 0063	
	Auxiliary relays	MW 0000 to 0191	
	Data registers	D 0000 to D 9999	

**Communications Settings**      The following communications settings are recommended for the PT and PLC.

### ■ PT Communications Settings

Item	Setting
Baud rate	19,200 bps
Data bits	8
Stop bits	1
Parity	None

### ■ PLC Communications Settings

Item	Setting
Unit number	00
Baud rate	19,200 bps
Data bits	8
Stop bits	1
Parity	None

## 6-1-1 Connection Method

### Connection Diagram

CPU	Adapter	Connection diagram	PT																																						
80S	RS-232C port on CPU Unit	<p>D-sub 9-pin connector on PLC</p> <table border="1"> <thead> <tr> <th>Pin No.</th> <th>Signal</th> </tr> </thead> <tbody> <tr><td>1</td><td>+5V</td></tr> <tr><td>2</td><td>RD1</td></tr> <tr><td>3</td><td>SD1</td></tr> <tr><td>4</td><td>RD2</td></tr> <tr><td>5</td><td>SG</td></tr> <tr><td>6</td><td>+5V</td></tr> <tr><td>7</td><td>SD2</td></tr> <tr><td>8</td><td>SG</td></tr> <tr><td>9</td><td>SG</td></tr> </tbody> </table> <p>To power supply</p> <table border="1"> <thead> <tr> <th>Pin No.</th> <th>Signal</th> </tr> </thead> <tbody> <tr><td>1</td><td>+</td></tr> <tr><td>2</td><td>-</td></tr> <tr><td>3</td><td>FG</td></tr> <tr><td>4</td><td>SD</td></tr> <tr><td>5</td><td>RD</td></tr> <tr><td>6</td><td>NC</td></tr> <tr><td>7</td><td>NC</td></tr> <tr><td>8</td><td>SG</td></tr> </tbody> </table>	Pin No.	Signal	1	+5V	2	RD1	3	SD1	4	RD2	5	SG	6	+5V	7	SD2	8	SG	9	SG	Pin No.	Signal	1	+	2	-	3	FG	4	SD	5	RD	6	NC	7	NC	8	SG	NV3W (-V1), NV4W, or NV3Q for RS-232C
Pin No.	Signal																																								
1	+5V																																								
2	RD1																																								
3	SD1																																								
4	RD2																																								
5	SG																																								
6	+5V																																								
7	SD2																																								
8	SG																																								
9	SG																																								
Pin No.	Signal																																								
1	+																																								
2	-																																								
3	FG																																								
4	SD																																								
5	RD																																								
6	NC																																								
7	NC																																								
8	SG																																								
200S	RS-232C port on CPU Unit																																								



CPU	Adapter	Connection diagram	PT
200S	G6L-CUEB	D-sub 9-pin connector on PLC 	NV3W (-V1), NV4W, or NV3Q for RS-232C
300S	G4L-CUEA		
1000S	G3L-CUEA		



# SECTION 7

## Connecting to Yokogawa PLCs

7-1	FA-M3 Series .....	62
7-1-1	Connecting through a Personal Computer Link Module.....	63
7-1-2	Direct Connection to CPU Module.....	63

## 7-1 FA-M3 Series

**PLC Model Selection**      Select Yokogawa FM-M3 Series.

### Applicable Devices

Bit/word devices		No.	Comments
Bit devices	Input relays	X 00201 to X 71664	Specify the slot number (1 digit) + unit number (2 digits) + terminal number (2 digits).
	Output relays	Y 00201 to Y 71664	Specify the slot number (2 digit) + unit number (2 digits) + terminal number (2 digits).
	Internal relays	I 00001 to I 65535	
	Link relays	L 00001 to L 78192	Specify the Series number (1 digit) + Link relay number (4 digits). Only series number 0 is valid.
	Timers	T 0001 to T 3072	
	Counters	C 0001 to C 3072	
Word devices	Input relays	X 00201 to X 71649	Specify 17, 33, or 49 for the lower two digits of the address.
	Output relays	Y 00201 to Y 71649	Specify 17, 33, or 49 for the lower two digits of the address.
	Auxiliary relays	I 00001 to I 65521	Specify addresses as multiples of 16 plus 1.
	Link relays	L 00001 to L 78177	Specify addresses so that the lower four digits is a multiple of 16 plus 1.
	Data registers	D 00001 to D 65535	
	Link registers	W 00001 to W 78192	Specify the Series number (1 digit) + Link register number (4 digits). Only series number 0 is valid.
	Timer current values	TP 0001 to TP 3072	
	Counter current values	CP 0001 to CP 3072	
	File registers	B 000001 to B 099999	

**Communications Settings**      The following communications settings are recommended for the PT and PLC.

#### ■ PT Communications Settings

Item	Setting
PLC station number	1
Baud rate	19,200 bps
Data bits	8
Stop bits	1
Parity	None

#### ■ PLC communications settings (Personal Computer Link Module)

Item	Setting
Station number	1
Baud rate	19,200 bps
Data bits	8
Stop bits	1
Parity	None
Checksum	None
End character specification	Enabled
Protection	None

### 7-1-1 Connecting through a Personal Computer Link Module.

Connection Diagram

CPU	Personal Computer Link Module	Connection diagram	PT
F3SP21-0N F3SP25-2N F3SP28-3N F3SP28-3S F3SP35-5N F3SP38-6N F3SP38-6S F3SP53-4H F3SP53-4S F3SP58-6H F3SP58-6S F3SP59-7S	F3LC11-1N F3LC11-1F F3LC12-1F		NV3W (-V1), NV4W, or NV3Q for RS-232C

### 7-1-2 Direct Connection to CPU Module

Connection Configuration between PLC and PT

As shown below, connect the PLC to a KM11-2T Programming Tool Cable and then connect the cable and the PT as shown below.

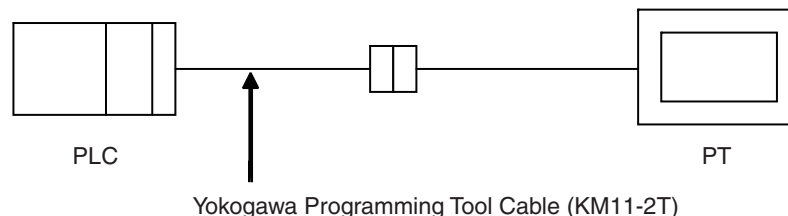

Connection Diagram

CPU	Conversion cable	Connection diagram	PT
F3SP21-0N F3SP25-2N F3SP28-3N F3SP28-3S F3SP35-5N F3SP38-6N F3SP38-6S F3SP53-4H F3SP53-4S F3SP58-6H F3SP58-6S F3SP59-7S	KM11-2T		NV3W (-V1), NV4W, or NV3Q for RS-232C



# SECTION 8

## Connecting to Keyence PLCs

8-1	KV-10/16/24/40 Series . . . . .	66
8-1-1	Connection Method . . . . .	67
8-2	KV-700 Series . . . . .	68
8-2-1	Connection Method . . . . .	69
8-3	Connecting through a KV-L20R/V (KV-700-series Unit) . . . . .	70
8-3-1	Connecting to the KV-700 Series . . . . .	71
8-4	KV-1000 Series . . . . .	72
8-4-1	Connecting to the KV-1000 Series . . . . .	73
8-5	Connecting through a KV-L20R/V (KV-1000-series Unit) . . . . .	74
8-5-1	Connection Method . . . . .	75
8-6	KV-3000 Series . . . . .	76
8-6-1	Connection Method . . . . .	77
8-7	Connecting through a KV-L20R/V (KV-3000/5000-series Unit) . . . . .	78
8-7-1	Connection Method . . . . .	80
8-8	KV Nano Series . . . . .	81
8-8-1	Connection Method . . . . .	83
8-9	Connecting through a KV-N10L (KV Nano-series Unit) . . . . .	84
8-9-1	Connection Method . . . . .	86

## 8-1 KV-10/16/24/40 Series

**PLC Model Selection**      Select Keyence KV10/16/24/40 Series.

### Applicable Devices

Bit/word devices		No	Comments
Bit devices	Relays	00000 to 17915	
	Timers	T 000 to T 249	
	Counters	C 000 to C 249	
	High-speed counters/CTH	CTH 0 to CTH 1	
	High-speed counter comparators	CTC 0 to CTC 3	Outputting to comparators is not possible.
Word devices	Data memory	DM 0000 to DM 1999	
	Temporary data memory	TM 000 to TM 31	
	Digital trimmers	AT 0 to AT 1	
	Timer present values	TC 000 to TC 249	
	Counter present values	CC 000 to CC 249	
	High-speed counter/CTH present values	CTHC 0 to CTHC 1	
	High-speed counter comparator present values	CTCC 0 to CTCC 3	
	Timer preset values	TS 000 to TS 249	
	Counter preset values	CS 000 to CS 249	
	High-speed counter/CTH preset values	CTHS 0 to CTHS 1	
	High-speed counter comparator preset values	CTCS 0 to CTCS 3	

- Note**
- (1) Outputting to high-speed counter comparators is not possible.
  - (2) Time will be required for communications due to restrictions in the PLC's communications protocol. Therefore, screen changes will slow and touch switch response will be poor.

**Communications Settings**      The following communications settings are recommended for the PT and PLC.

#### ■ PT Communications Settings

Item	Setting
Baud rate	9,600 bps
Data bits	8
Stop bits	1
Parity	Even



### 8-1-1 Connection Method

#### Connection Diagram

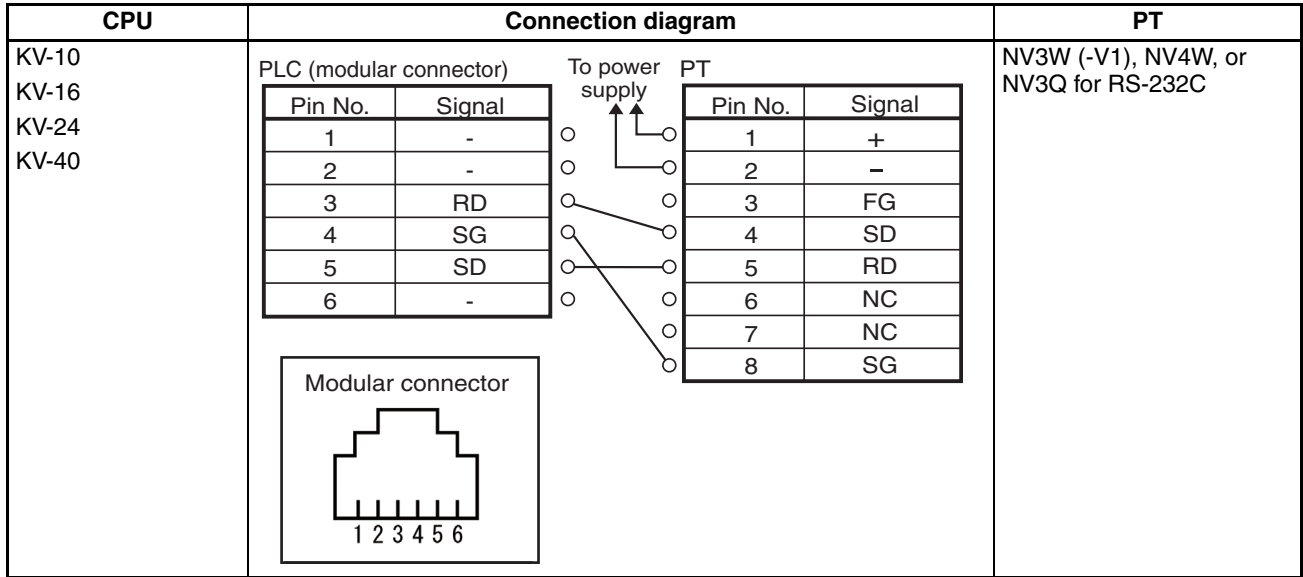

## 8-2 KV-700 Series

**PLC Model Selection**      Select Keyence KV700 Series.

### Applicable Devices

Bit/word devices		No.	Comments
Bit devices	Relays	00000 to 59915	
	Control relays	CR 0000 to CR 3915	
	Timers	T 000 to T 511	
	Counters	C 000 to C 511	
	High-speed counter comparators	CTC 0 to CTC 3	Outputting to high-speed counter comparators is not possible.
Word devices	Data memory	DM 00000 to DM 39999	
	Controller memory	CM 0000 to CM 3999	
	Temporary data memory	TM 000 to TM 511	
Double-word devices	Digital trimmers	AT 0 to AT 7	
	Timer present values	T/TC 000 to T/TC 511	
	Counter present values	C/CC 000 to C/CC 511	
	High-speed counter present values	CTH 0 to CTH 1	
	Timer preset values	T/TS 000 to T/TS 511	
	Counter preset values	C/CS 000 to C/CS 511	
	High-speed counter comparator preset values	CTC 0 to CTC 3	

**Communications Settings**      The following communications settings are recommended for the PT and PLC.

■ **PT Communications Settings (Set from the NV-Designer using the NV Configuration.)**

Item	Setting
Baud rate	9,600 bps
Data bits	8
Stop bits	1
Parity	Even

### 8-2-1 Connection Method

#### Connection Diagram

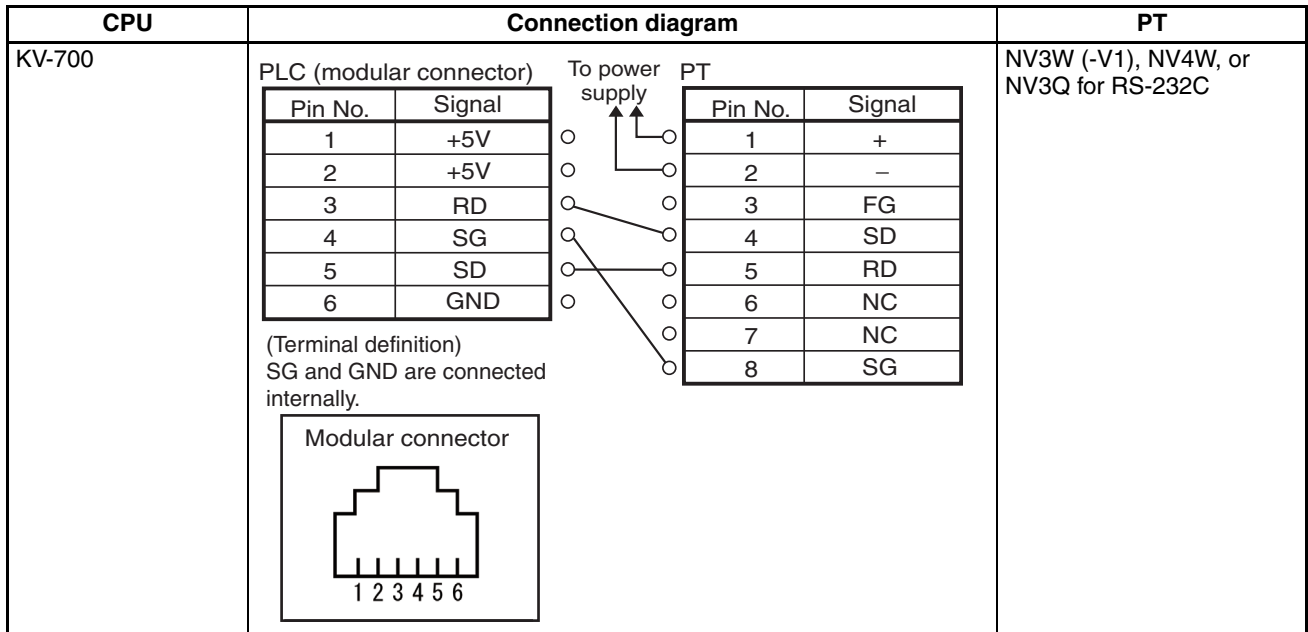

## 8-3 Connecting through a KV-L20R/V (KV-700-series Unit)

PLC Model Selection      Select Keyence KV700 Series.

### Applicable Devices

Bit/word devices		No.	Comments
Bit devices	Relays	00000 to 59915	
	Control relays	CR 0000 to CR 3915	
	Timers	T 000 to T 511	
	Counters	C 000 to C 511	
	High-speed counter comparators	CTC 0 to CTC 3	Outputting to high-speed counter comparators is not possible.
Word devices	Data memory	DM 00000 to DM 39999	
	Controller memory	CM 0000 to CM 3999	
	Temporary data memory	TM 000 to TM 511	
Double-word devices	Digital trimmers	AT 0 to AT 7	
	Timer present values	T/TC 000 to T/TC 511	
	Counter present values	C/CC 000 to C/CC 511	
	High-speed counter present values	CTH 0 to CTH 1	
	Timer preset values	T/TS 000 to T/TS 511	
	Counter preset values	C/CS 000 to C/CS 511	
	High-speed counter comparator preset values	CTC 0 to CTC 3	

**Communications Settings**      The following communications settings are recommended for the PT and PLC.

#### ■ PT Communications Settings (Set from the NV-Designer using the NV Configuration.)

Item	Setting
Baud rate	9,600 bps, 19,200 bps, 38,400 bps, 57,600 bps, or 115,200 bps
Data bits	8
Stop bits	1
Parity	Even

#### ■ KV-L20R Settings

Item	Setting
Operating mode	KV mode (host link)
Baud rate	9,600 bps, 19,200 bps, 38,400 bps, 57,600 bps, or 115,200 bps
RS/CS flow control	None

**Note** Use the Unit Editor included with the KV Builder to set the KV-L20R/V.

### 8-3-1 Connecting to the KV-700 Series

#### Connection Configuration between PLC and PT

As shown below, connect the KV-L20R/V Unit to the KV-700 and then connect the KV-L20R/V and the PT as shown below.

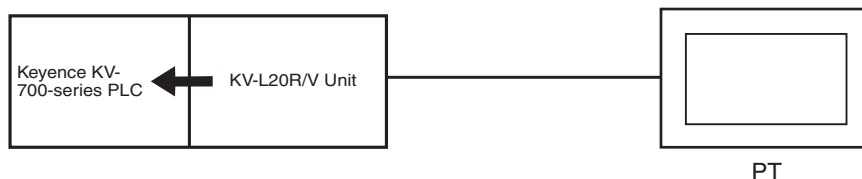

#### Connection Diagram

CPU	Unit	Connection diagram	PT																																						
KV-700	KV-L20R/V (port 1)	<p>D-sub 9-pin connector on KV-L20R/V</p> <table border="1"> <thead> <tr> <th>Pin No.</th> <th>Signal</th> </tr> </thead> <tbody> <tr><td>1</td><td>-</td></tr> <tr><td>2</td><td>RD</td></tr> <tr><td>3</td><td>SD</td></tr> <tr><td>4</td><td>-</td></tr> <tr><td>5</td><td>SG</td></tr> <tr><td>6</td><td>-</td></tr> <tr><td>7</td><td>RS</td></tr> <tr><td>8</td><td>CS</td></tr> <tr><td>9</td><td>-</td></tr> </tbody> </table> <p>To power supply</p> <table border="1"> <thead> <tr> <th>Pin No.</th> <th>Signal</th> </tr> </thead> <tbody> <tr><td>1</td><td>+</td></tr> <tr><td>2</td><td>-</td></tr> <tr><td>3</td><td>FG</td></tr> <tr><td>4</td><td>SD</td></tr> <tr><td>5</td><td>RD</td></tr> <tr><td>6</td><td>NC</td></tr> <tr><td>7</td><td>NC</td></tr> <tr><td>8</td><td>SG</td></tr> </tbody> </table>	Pin No.	Signal	1	-	2	RD	3	SD	4	-	5	SG	6	-	7	RS	8	CS	9	-	Pin No.	Signal	1	+	2	-	3	FG	4	SD	5	RD	6	NC	7	NC	8	SG	NV3W (-V1), NV4W, or NV3C for RS-232C
Pin No.	Signal																																								
1	-																																								
2	RD																																								
3	SD																																								
4	-																																								
5	SG																																								
6	-																																								
7	RS																																								
8	CS																																								
9	-																																								
Pin No.	Signal																																								
1	+																																								
2	-																																								
3	FG																																								
4	SD																																								
5	RD																																								
6	NC																																								
7	NC																																								
8	SG																																								
KV-700	KV-L20R/L (port 2)	<p>KV-L20R/V</p> <table border="1"> <thead> <tr> <th>Pin No.</th> <th>Signal</th> </tr> </thead> <tbody> <tr><td>1</td><td>SG</td></tr> <tr><td>2</td><td>RDA(-)</td></tr> <tr><td>3</td><td>SDA(-)</td></tr> <tr><td>4</td><td>RDB(+)</td></tr> <tr><td>5</td><td>SDB(+)</td></tr> </tbody> </table> <p>To power supply</p> <table border="1"> <thead> <tr> <th>Pin No.</th> <th>Signal</th> </tr> </thead> <tbody> <tr><td>1</td><td>+</td></tr> <tr><td>2</td><td>-</td></tr> <tr><td>3</td><td>FG</td></tr> <tr><td>4</td><td>+SD</td></tr> <tr><td>5</td><td>-SD</td></tr> <tr><td>6</td><td>+RD</td></tr> <tr><td>7</td><td>-RD</td></tr> <tr><td>8</td><td>Terminator setting (built-in 120 Ω resistance)</td></tr> </tbody> </table>	Pin No.	Signal	1	SG	2	RDA(-)	3	SDA(-)	4	RDB(+)	5	SDB(+)	Pin No.	Signal	1	+	2	-	3	FG	4	+SD	5	-SD	6	+RD	7	-RD	8	Terminator setting (built-in 120 Ω resistance)	NV3W (-V1), NV4W, or NV3Q for RS-422A								
Pin No.	Signal																																								
1	SG																																								
2	RDA(-)																																								
3	SDA(-)																																								
4	RDB(+)																																								
5	SDB(+)																																								
Pin No.	Signal																																								
1	+																																								
2	-																																								
3	FG																																								
4	+SD																																								
5	-SD																																								
6	+RD																																								
7	-RD																																								
8	Terminator setting (built-in 120 Ω resistance)																																								
KV-700	KV-L20R/V (port 2)	<p>KV-L20R/V</p> <table border="1"> <thead> <tr> <th>Pin No.</th> <th>Signal</th> </tr> </thead> <tbody> <tr><td>1</td><td>SG</td></tr> <tr><td>2</td><td>-</td></tr> <tr><td>3</td><td>S/R(-)</td></tr> <tr><td>4</td><td>-</td></tr> <tr><td>5</td><td>S/R(+)</td></tr> </tbody> </table> <p>To power supply</p> <table border="1"> <thead> <tr> <th>Pin No.</th> <th>Signal</th> </tr> </thead> <tbody> <tr><td>1</td><td>+</td></tr> <tr><td>2</td><td>-</td></tr> <tr><td>3</td><td>FG</td></tr> <tr><td>4</td><td>+SD</td></tr> <tr><td>5</td><td>-SD</td></tr> <tr><td>6</td><td>+RD</td></tr> <tr><td>7</td><td>-RD</td></tr> <tr><td>8</td><td>Terminator setting (built-in 120 Ω resistance)</td></tr> </tbody> </table>	Pin No.	Signal	1	SG	2	-	3	S/R(-)	4	-	5	S/R(+)	Pin No.	Signal	1	+	2	-	3	FG	4	+SD	5	-SD	6	+RD	7	-RD	8	Terminator setting (built-in 120 Ω resistance)	NV3W (-V1), NV4W, or NV3Q for RS-485								
Pin No.	Signal																																								
1	SG																																								
2	-																																								
3	S/R(-)																																								
4	-																																								
5	S/R(+)																																								
Pin No.	Signal																																								
1	+																																								
2	-																																								
3	FG																																								
4	+SD																																								
5	-SD																																								
6	+RD																																								
7	-RD																																								
8	Terminator setting (built-in 120 Ω resistance)																																								

## 8-4 KV-1000 Series

**PLC Model Selection**      Select Keyence KV1000 Series.

### Applicable Devices

Bit/word devices		No.	Comments
Bit devices	Relays	00000 to 59915	
	Control relays	CR 0000 to CR 3915	
	Internal auxiliary relays	MR 00000 to MR 99915	
	Latching relays	LR 00000 to LR 99915	
	Timers	T 0000 to T 3999	
	Counters	C 0000 to C 3999	
	High-speed counter comparators	CTC 0 to CTC 3	Outputting to high-speed counter comparators is not possible.
Word devices	Data memory	DM 00000 to DM 65534	
	Controller memory	CM 0000 to CM 11998	
	Temporary data memory	TM 000 to TM 511	
	Expansion data memory	EM 00000 to EM 65534	
	File memory	FM 00000 to FM 32766	
	Index registers	Z 01 to Z 12	
Double-word devices	Digital trimmers	AT 0 to AT 7	
	Timer present values	T/TC 0000 to T/TC 3999	
	Counter present values	C/CC 0000 to C/CC 3999	
	High-speed counter present values	CTH 0 to CTH 1	
	Timer preset values	T/TS 0000 to T/TS 3999	
	Counter preset values	C/CS 0000 to C/CS 3999	
	High-speed counter comparator preset values	CTC 0 to CTC 3	

**Communications Settings**      The following communications settings are recommended for the PT and PLC.

■ **PT Communications Settings (Set from the NV-Designer using the NV Configuration.)**

Item	Setting
Baud rate	9,600 bps, 19,200 bps, 38,400 bps, 57,600 bps, or 115,200 bps
Data bits	8
Stop bits	1
Parity	Even

### 8-4-1 Connecting to the KV-1000 Series

#### Connection Diagram

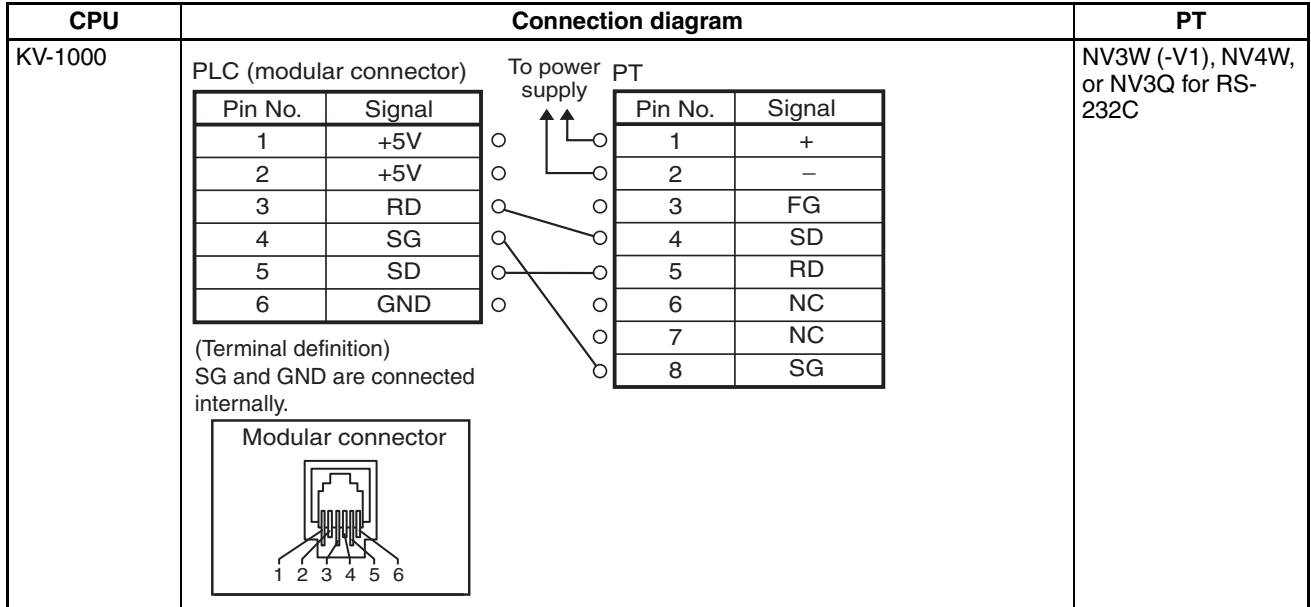

## 8-5 Connecting through a KV-L20R/V (KV-1000-series Unit)

PLC Model Selection      Select Keyence KV1000 Series.

### Applicable Devices

Bit/word devices		No.	Comments
Bit devices	Relays	00000 to 59915	
	Control relays	CR 0000 to CR 3915	
	Timers	T 000 to T 511	
	Counters	C 000 to C 511	
	High-speed counter comparators	CTC 0 to CTC 3	Outputting to high-speed counter comparators is not possible.
Word devices	Data memory	DM 00000 to DM 39999	
	Controller memory	CM 0000 to CM 3999	
	Temporary data memory	TM 000 to TM 511	
Double-word devices	Digital trimmers	AT 0 to AT 7	
	Timer present values	T/TC 000 to T/TC 511	
	Counter present values	C/CC 000 to C/CC 511	
	High-speed counter present values	CTH 0 to CTH 1	
	Timer preset values	T/TS 000 to T/TS 511	
	Counter preset values	C/CS 000 to C/CS 511	
	High-speed counter comparator preset values	CTC 0 to CTC 3	

**Communications Settings**      The following communications settings are recommended for the PT and PLC.

#### ■ PT Communications Settings (Set from the NV-Designer using the NV Configuration.)

Item	Setting
Baud rate	9,600 bps, 19,200 bps, 38,400 bps, 57,600 bps, or 115,200 bps
Data bits	8
Stop bits	1
Parity	Even

#### ■ KV-L20R Settings

Item	Setting
Operating mode	KV mode (host link)
Baud rate	9,600 bps, 19,200 bps, 38,400 bps, 57,600 bps, or 115,200 bps
RS/CS flow control	None

**Note** Use the Unit Editor included with the KV Builder to set the KV-L20R/V.



### 8-5-1 Connection Method

#### Connection Configuration between PLC and PT

As shown below, connect the KV-L20R/V Unit to the KV-1000 and then connect the KV-L20R/V and the PT as shown below.

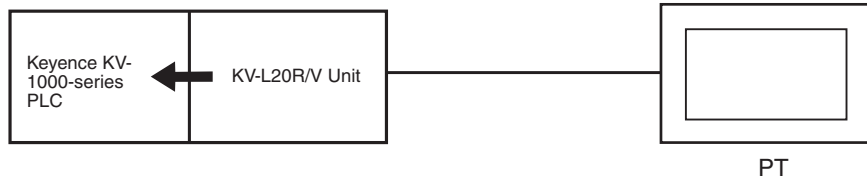

#### Connection Diagram

CPU	Unit	Connection diagram	PT																																						
KV-1000	KV-L20R/V (port 1)	<p>D-sub 9-pin connector on KV-L20R/V</p> <table border="1"> <thead> <tr> <th>Pin No.</th> <th>Signal</th> </tr> </thead> <tbody> <tr><td>1</td><td>-</td></tr> <tr><td>2</td><td>RD</td></tr> <tr><td>3</td><td>SD</td></tr> <tr><td>4</td><td>-</td></tr> <tr><td>5</td><td>SG</td></tr> <tr><td>6</td><td>-</td></tr> <tr><td>7</td><td>RS</td></tr> <tr><td>8</td><td>CS</td></tr> <tr><td>9</td><td>-</td></tr> </tbody> </table> <p>To power supply</p> <table border="1"> <thead> <tr> <th>Pin No.</th> <th>Signal</th> </tr> </thead> <tbody> <tr><td>1</td><td>+</td></tr> <tr><td>2</td><td>-</td></tr> <tr><td>3</td><td>FG</td></tr> <tr><td>4</td><td>SD</td></tr> <tr><td>5</td><td>RD</td></tr> <tr><td>6</td><td>NC</td></tr> <tr><td>7</td><td>NC</td></tr> <tr><td>8</td><td>SG</td></tr> </tbody> </table>	Pin No.	Signal	1	-	2	RD	3	SD	4	-	5	SG	6	-	7	RS	8	CS	9	-	Pin No.	Signal	1	+	2	-	3	FG	4	SD	5	RD	6	NC	7	NC	8	SG	NV3W (-V1), NV4W, or NV3Q for RS-232C
Pin No.	Signal																																								
1	-																																								
2	RD																																								
3	SD																																								
4	-																																								
5	SG																																								
6	-																																								
7	RS																																								
8	CS																																								
9	-																																								
Pin No.	Signal																																								
1	+																																								
2	-																																								
3	FG																																								
4	SD																																								
5	RD																																								
6	NC																																								
7	NC																																								
8	SG																																								
KV-1000	KV-L20R/L (port 2)	<p>KV-L20R/V</p> <table border="1"> <thead> <tr> <th>Pin No.</th> <th>Signal</th> </tr> </thead> <tbody> <tr><td>1</td><td>SG</td></tr> <tr><td>2</td><td>RDA(-)</td></tr> <tr><td>3</td><td>SDA(-)</td></tr> <tr><td>4</td><td>RDB(+)</td></tr> <tr><td>5</td><td>SDB(+)</td></tr> </tbody> </table> <p>To power supply</p> <table border="1"> <thead> <tr> <th>Pin No.</th> <th>Signal</th> </tr> </thead> <tbody> <tr><td>1</td><td>+</td></tr> <tr><td>2</td><td>-</td></tr> <tr><td>3</td><td>FG</td></tr> <tr><td>4</td><td>+SD</td></tr> <tr><td>5</td><td>-SD</td></tr> <tr><td>6</td><td>+RD</td></tr> <tr><td>7</td><td>-RD</td></tr> <tr><td>8</td><td>Terminator setting (built-in 120 Ω resistance)</td></tr> </tbody> </table>	Pin No.	Signal	1	SG	2	RDA(-)	3	SDA(-)	4	RDB(+)	5	SDB(+)	Pin No.	Signal	1	+	2	-	3	FG	4	+SD	5	-SD	6	+RD	7	-RD	8	Terminator setting (built-in 120 Ω resistance)	NV3W (-V1), NV4W, or NV3Q for RS-422A								
Pin No.	Signal																																								
1	SG																																								
2	RDA(-)																																								
3	SDA(-)																																								
4	RDB(+)																																								
5	SDB(+)																																								
Pin No.	Signal																																								
1	+																																								
2	-																																								
3	FG																																								
4	+SD																																								
5	-SD																																								
6	+RD																																								
7	-RD																																								
8	Terminator setting (built-in 120 Ω resistance)																																								
KV-1000	KV-L20R/V (port 2)	<p>KV-L20R/V</p> <table border="1"> <thead> <tr> <th>Pin No.</th> <th>Signal</th> </tr> </thead> <tbody> <tr><td>1</td><td>SG</td></tr> <tr><td>2</td><td>-</td></tr> <tr><td>3</td><td>S/R(-)</td></tr> <tr><td>4</td><td>-</td></tr> <tr><td>5</td><td>S/R(+)</td></tr> </tbody> </table> <p>To power supply</p> <table border="1"> <thead> <tr> <th>Pin No.</th> <th>Signal</th> </tr> </thead> <tbody> <tr><td>1</td><td>+</td></tr> <tr><td>2</td><td>-</td></tr> <tr><td>3</td><td>FG</td></tr> <tr><td>4</td><td>+SD</td></tr> <tr><td>5</td><td>-SD</td></tr> <tr><td>6</td><td>+RD</td></tr> <tr><td>7</td><td>-RD</td></tr> <tr><td>8</td><td>Terminator setting (built-in 120 Ω resistance)</td></tr> </tbody> </table>	Pin No.	Signal	1	SG	2	-	3	S/R(-)	4	-	5	S/R(+)	Pin No.	Signal	1	+	2	-	3	FG	4	+SD	5	-SD	6	+RD	7	-RD	8	Terminator setting (built-in 120 Ω resistance)	NV3W (-V1), NV4W, or NV3Q for RS-485								
Pin No.	Signal																																								
1	SG																																								
2	-																																								
3	S/R(-)																																								
4	-																																								
5	S/R(+)																																								
Pin No.	Signal																																								
1	+																																								
2	-																																								
3	FG																																								
4	+SD																																								
5	-SD																																								
6	+RD																																								
7	-RD																																								
8	Terminator setting (built-in 120 Ω resistance)																																								

## 8-6 KV-3000 Series

### PLC Model Selection

Select Keyence KV3000/5000 Series.

**Note** You cannot connect the PT directly to a KV-5000-series CPU.

### Applicable Devices

Bit/word devices		No.	Comments
Bit devices	Input relays	R 00000 to R 99915	
	Output relays		
	Internal auxiliary relays		
	Link relays	B 0000 to B 3FFF	
	Control relays	CR 0000 to CR 3915	
	Internal auxiliary relays	MR 00000 to MR 99915	
	Latched relays	LR 00000 to LR 99915	
	Work relays	VB 0000 to VB 3FFF	
	Timer contacts	T 0000 to T 3999	
Counter contacts	C 0000 to C 3999		
	High-speed counter comparator contacts	CTC 0 to CTC 3	Outputting to high-speed counter comparators is not possible.
Word devices	Data memory	DM 00000 to DM 65534	
	Controller memory	CM 00000 to CM 05999	
	Temporary data memory	TM 000 to TM 511	
	Expansion data memory	EM 00000 to EM 65534	
	File registers, current bank	FM 00000 to FM 32767	
	File registers, continuous	ZF 000000 to ZF 131071	
	Link registers	W 0000 to W 3FFF	
	Work memory	VM 00000 to VM 59999	
Double-word devices	Digital trimmers	TRM 0 to TRM 7	Outputting to digital trimmers is not possible.
	Timer current values	TC 0000 to TC 3999	
	Counter current values	CC 0000 to CC 3999	
	High-speed counter current values	CTH 0 to CTH 1	
	Timer preset values	TS 0000 to TS 3999	
	Counter preset values	CS 0000 to CS 3999	
	High-speed counter comparator preset values	CTC 0 to CTC 3	
	Index registers	Z 01 to Z 12	

**Communications Settings** The following communications settings are recommended for the PT and PLC.

■ **PT Communications Settings (Set from the NV-Designer using the NV Configuration.)**

Item	Setting
Baud rate	9,600 bps, 19,200 bps, 38,400 bps, 57,600 bps, or 115,200 bps
Data bits	8
Stop bits	1
Parity	Even

### 8-6-1 Connection Method

#### Connection Diagram

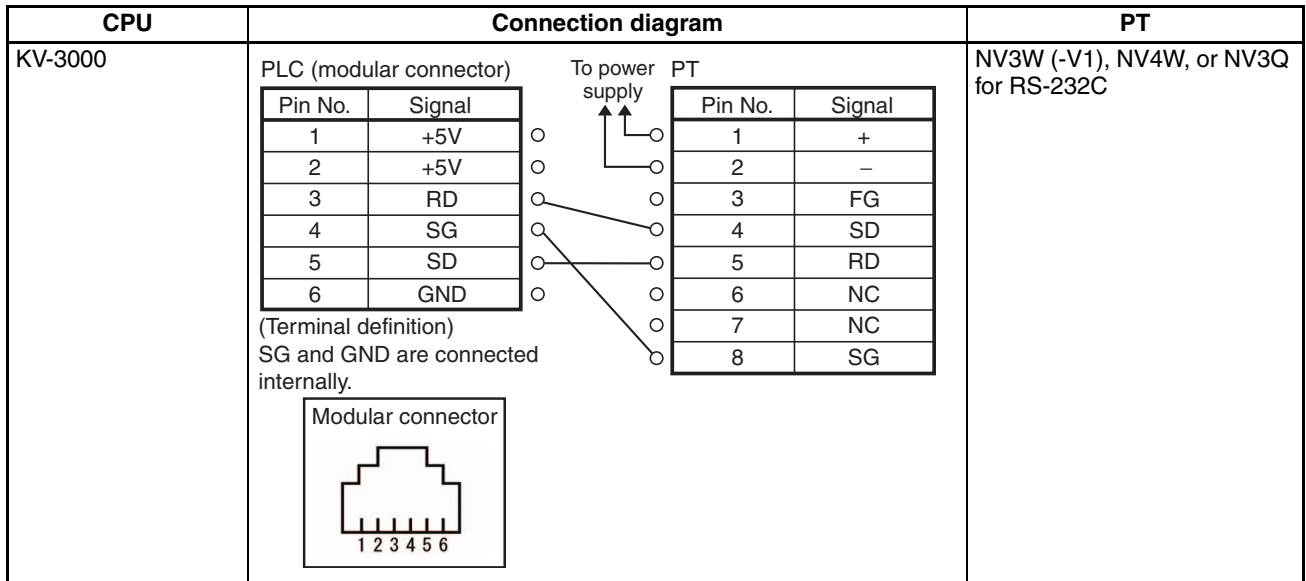

## 8-7 Connecting through a KV-L20R/V (KV-3000/5000-series Unit)

**PLC Model Selection**      Select Keyence KV3000/5000 Series.

### Applicable Devices

Bit/word devices		No.	Comments
Bit devices	Input relays	R 0000 to R 99915	
	Output relays		
	Internal auxiliary relays		
	Link relays	B 0000 to B 3FFF	
	Control relays	CR 0000 to CR 3915	
	Internal auxiliary relays	MR 00000 to MR 99915	
	Latched relays	LR 00000 to LR 99915	
	Work relays	VB 0000 to VB 3FFF	
	Timer contacts	T 0000 to T 3999	
	Counter contacts	C 0000 to C 3999	
	High-speed counter comparator contacts	CTC 0 to CTC 3	Outputting to high-speed counter comparators is not possible.
Word devices	Data memory	DM 00000 to DM 65534	
	Controller memory	CM 00000 to CM 05999	
	Temporary data memory	TM 000 to TM 511	
	Expansion data memory	EM 00000 to EM 65534	
	File registers, current bank	FM 00000 to FM 32767	
	File registers, continuous	ZF 000000 to ZF 131071	
	Link registers	W 0000 to W 3FFF	
	Work memory	VM 00000 to VM 59999	
Double-word devices	Digital trimmers	TRM 0 to TRM 7	Outputting to digital trimmers is not possible.
	Timer current values	TC 0000 to TC 3999	
	Counter current values	CC 0000 to CC 3999	
	High-speed counter current values	CTH 0 to CTH 1	
	Timer preset values	TS 0000 to TS 3999	
	Counter preset values	CS 0000 to CS 3999	
	High-speed counter comparator preset values	CTC 0 to CTC 3	
	Index registers	Z 01 to Z 12	

**Communications Settings**      The following communications settings are recommended for the PT and PLC.

■ **PT Communications Settings (Set from the NV-Designer using the NV Configuration.)**

Item	Setting
Baud rate	9,600 bps, 19,200 bps, 38,400 bps, 57,600 bps, or 115,200 bps
Data bits	8
Stop bits	1
Parity	Even

**■ KV-L20R Settings (Port 1)**

<b>Item</b>	<b>Setting</b>
Operating mode	KV mode (host link)
Baud rate	9,600 bps, 19,200 bps, 38,400 bps, 57,600 bps, or 115,200 bps
RS/CS flow control	None

- Note**
- (1) Use port 1.
  - (2) Use the Unit Editor included with the KV Builder to set the KV-L20R/V.

### 8-7-1 Connection Method

#### Connection Configuration between PLC and PT

As shown below, connect the KV-L20R/V Unit to the KV-3000 or KV-5000 and then connect the KV-L20R/V and the PT as shown below.

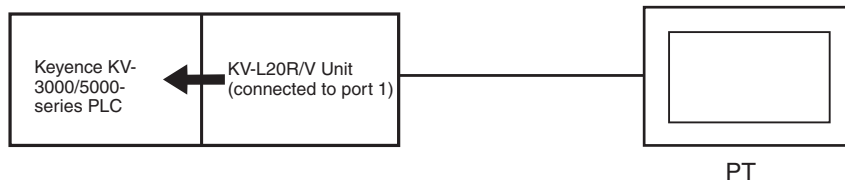

#### Connection Diagram

CPU	Unit	Connection diagram	PT																																						
KV-3000 KV-5000	KV-L20R/V (port 1)	<p>D-sub 9-pin connector on KV-L20R/V</p> <table border="1"> <thead> <tr> <th>Pin No.</th> <th>Signal</th> </tr> </thead> <tbody> <tr><td>1</td><td>-</td></tr> <tr><td>2</td><td>RD</td></tr> <tr><td>3</td><td>SD</td></tr> <tr><td>4</td><td>-</td></tr> <tr><td>5</td><td>SG</td></tr> <tr><td>6</td><td>-</td></tr> <tr><td>7</td><td>RS</td></tr> <tr><td>8</td><td>CS</td></tr> <tr><td>9</td><td>-</td></tr> </tbody> </table> <p>To power supply</p> <table border="1"> <thead> <tr> <th>Pin No.</th> <th>Signal</th> </tr> </thead> <tbody> <tr><td>1</td><td>+</td></tr> <tr><td>2</td><td>-</td></tr> <tr><td>3</td><td>FG</td></tr> <tr><td>4</td><td>SD</td></tr> <tr><td>5</td><td>RD</td></tr> <tr><td>6</td><td>NC</td></tr> <tr><td>7</td><td>NC</td></tr> <tr><td>8</td><td>SG</td></tr> </tbody> </table> <p>PT</p>	Pin No.	Signal	1	-	2	RD	3	SD	4	-	5	SG	6	-	7	RS	8	CS	9	-	Pin No.	Signal	1	+	2	-	3	FG	4	SD	5	RD	6	NC	7	NC	8	SG	NV3W (-V1), NV4W, or NV3Q for RS-232C
Pin No.	Signal																																								
1	-																																								
2	RD																																								
3	SD																																								
4	-																																								
5	SG																																								
6	-																																								
7	RS																																								
8	CS																																								
9	-																																								
Pin No.	Signal																																								
1	+																																								
2	-																																								
3	FG																																								
4	SD																																								
5	RD																																								
6	NC																																								
7	NC																																								
8	SG																																								
KV-3000 KV-5000	KV-L20R/L (port 2)	<p>KV-L20R/V</p> <table border="1"> <thead> <tr> <th>Pin No.</th> <th>Signal</th> </tr> </thead> <tbody> <tr><td>1</td><td>SG</td></tr> <tr><td>2</td><td>RDA(-)</td></tr> <tr><td>3</td><td>SDA(-)</td></tr> <tr><td>4</td><td>RDB(+)</td></tr> <tr><td>5</td><td>SDB(+)</td></tr> </tbody> </table> <p>To power supply</p> <table border="1"> <thead> <tr> <th>Pin No.</th> <th>Signal</th> </tr> </thead> <tbody> <tr><td>1</td><td>+</td></tr> <tr><td>2</td><td>-</td></tr> <tr><td>3</td><td>FG</td></tr> <tr><td>4</td><td>+SD</td></tr> <tr><td>5</td><td>-SD</td></tr> <tr><td>6</td><td>+RD</td></tr> <tr><td>7</td><td>-RD</td></tr> <tr><td>8</td><td>Terminator setting (built-in 120 Ω resistance)</td></tr> </tbody> </table> <p>PT</p>	Pin No.	Signal	1	SG	2	RDA(-)	3	SDA(-)	4	RDB(+)	5	SDB(+)	Pin No.	Signal	1	+	2	-	3	FG	4	+SD	5	-SD	6	+RD	7	-RD	8	Terminator setting (built-in 120 Ω resistance)	NV3W (-V1), NV4W, or NV3Q for RS-422A								
Pin No.	Signal																																								
1	SG																																								
2	RDA(-)																																								
3	SDA(-)																																								
4	RDB(+)																																								
5	SDB(+)																																								
Pin No.	Signal																																								
1	+																																								
2	-																																								
3	FG																																								
4	+SD																																								
5	-SD																																								
6	+RD																																								
7	-RD																																								
8	Terminator setting (built-in 120 Ω resistance)																																								
KV-3000 KV-5000	KV-L20R/V (port 2)	<p>KV-L20R/V</p> <table border="1"> <thead> <tr> <th>Pin No.</th> <th>Signal</th> </tr> </thead> <tbody> <tr><td>1</td><td>SG</td></tr> <tr><td>2</td><td>-</td></tr> <tr><td>3</td><td>S/R(-)</td></tr> <tr><td>4</td><td>-</td></tr> <tr><td>5</td><td>S/R(+)</td></tr> </tbody> </table> <p>To power supply</p> <table border="1"> <thead> <tr> <th>Pin No.</th> <th>Signal</th> </tr> </thead> <tbody> <tr><td>1</td><td>+</td></tr> <tr><td>2</td><td>-</td></tr> <tr><td>3</td><td>FG</td></tr> <tr><td>4</td><td>+SD</td></tr> <tr><td>5</td><td>-SD</td></tr> <tr><td>6</td><td>+RD</td></tr> <tr><td>7</td><td>-RD</td></tr> <tr><td>8</td><td>Terminator setting (built-in 120 Ω resistance)</td></tr> </tbody> </table> <p>PT</p>	Pin No.	Signal	1	SG	2	-	3	S/R(-)	4	-	5	S/R(+)	Pin No.	Signal	1	+	2	-	3	FG	4	+SD	5	-SD	6	+RD	7	-RD	8	Terminator setting (built-in 120 Ω resistance)	NV3W (-V1), NV4W, or NV3Q for RS-485								
Pin No.	Signal																																								
1	SG																																								
2	-																																								
3	S/R(-)																																								
4	-																																								
5	S/R(+)																																								
Pin No.	Signal																																								
1	+																																								
2	-																																								
3	FG																																								
4	+SD																																								
5	-SD																																								
6	+RD																																								
7	-RD																																								
8	Terminator setting (built-in 120 Ω resistance)																																								

## 8-8 KV Nano Series

### ■ Connectable NV Models and Versions

Models	Applicable Versions
NV3W	Not supported.
NV3W-V1	Ver. 2.00 or higher
NV4W	Ver. 2.00 or higher
NV3Q	Ver. 2.00 or higher

### ■ PLC Model Selection

Select Keyence KV-3000/5000 Series.

### Applicable Devices

Bit/word devices		No.	Comments
Bit devices	Input relays	R 00000 to R 59915	
	Output relays		
	Internal auxiliary relays		
	Link relays	B 0000 to B 1FFF	
	Control relays	CR 0000 to CR 8915	
	Internal auxiliary relays	MR 00000 to MR 59915	
	Latched relays	LR 00000 to LR 19915	
Word devices	Work relays	VB 0000 to VB 1FFF	
	Data memory	DM 00000 to DM 32767	
	Controller memory	CM 0000 to CM 8999	
	Temporary data memory	TM 000 to TM 511	
	Link registers	W 0000 to W 3FFF	
Double-word devices	Work memory	VM 0000 to VM 9999	
	Index registers	Z 01 to Z 12	

**Communications Settings** The following communications settings are recommended for the PT and PLC.

■ **PT Communications Settings (Set from the NV-Designer using the NV Configuration.)**

Item	Setting
Baud rate	9,600 bps, 19,200 bps, 38,400 bps, 57,600 bps, or 115,200 bps
Data bits	8
Stop bits	1
Parity	Even

■ **PLC Communications Settings**

Item	Setting
Operating mode	KV mode (host link)
Baud rate	9,600 bps, 19,200 bps, 38,400 bps, 57,600 bps, or 115,200 bps
RS/CS flow control	None



### 8-8-1 Connection Method

#### Connection Diagram

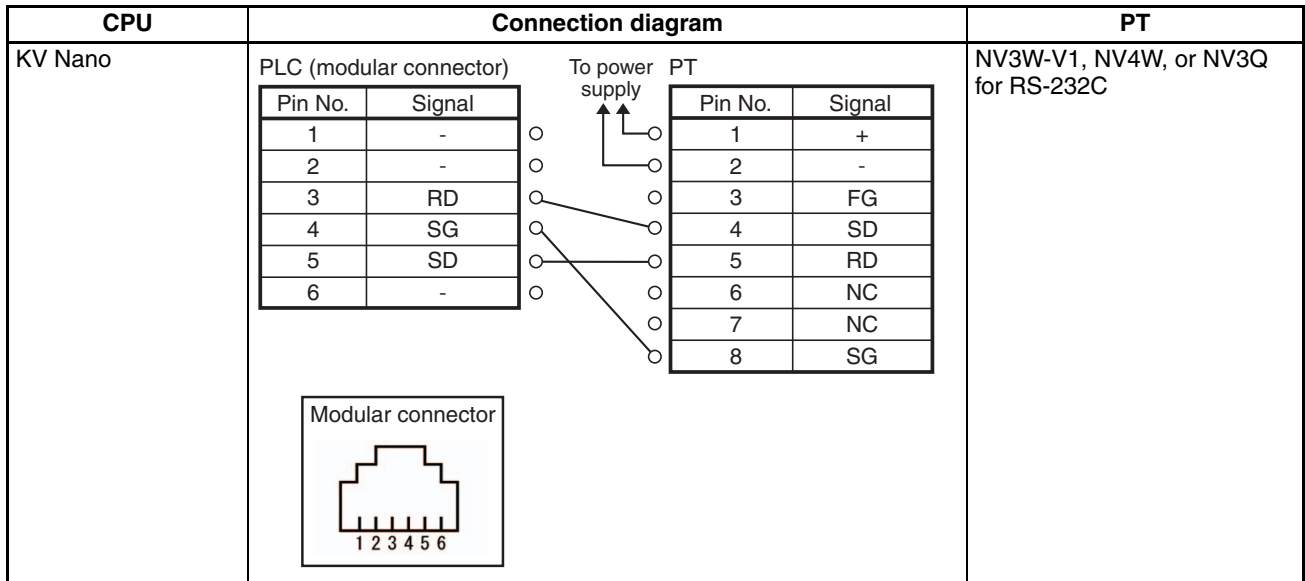

## 8-9 Connecting through a KV-N10L (KV Nano-series Unit)

### ■ Connectable NV Models and Versions

Models	Applicable Versions
NV3W	Not supported.
NV3W-V1	Ver. 2.00 or higher
NV4W	Ver. 2.00 or higher
NV3Q	Ver. 2.00 or higher

### ■ PLC Model Selection

Select Keyence KV-3000/5000 Series.

### Applicable Devices

Bit/word devices	No.	Comments	
Bit devices	Input relays Output relays Internal auxiliary relays	R 0000 to R 59915	
	Link relays	B 0000 to B 1FFF	
	Control relays	CR 0000 to CR 8915	
	Internal auxiliary relays	MR 00000 to MR 59915	
	Latched relays	LR 00000 to LR 19915	
	Work relays	VB 0000 to VB 1FFF	
	Word devices	Data memory	DM 00000 to DM 32767
Controller memory		CM 0000 to CM 8999	
Temporary data memory		TM 000 to TM 511	
Link registers		W 0000 to W 3FFF	
Work memory		VM 0000 to VM 9999	
Double-word devices	Index registers	Z 01 to Z 12	

**Communications Settings** The following communications settings are recommended for the PT and PLC.

■ **PT Communications Settings (Set from the NV-Designer using the NV Configuration.)**

Item	Setting
Baud rate	9,600 bps, 19,200 bps, 38,400 bps, 57,600 bps, or 115,200 bps
Data bits	8
Stop bits	1
Parity	Even

■ **KV-N10L Settings (port 1)**

Item	Setting
Operating mode	KV mode (host link)
Baud rate	9,600 bps, 19,200 bps, 38,400 bps, 57,600 bps, or 115,200 bps
RS/CS flow control	None

- Note**
- (1) Use port 1.
  - (2) Use the Unit Editor included with the KV Builder to set the KV-N10L.

### 8-9-1 Connection Method

#### Connection Configuration between PLC and PT

As shown below, connect the KV-N10L Unit to the KV Nano series PLC and then connect the KV-N10L and the PT as shown below.

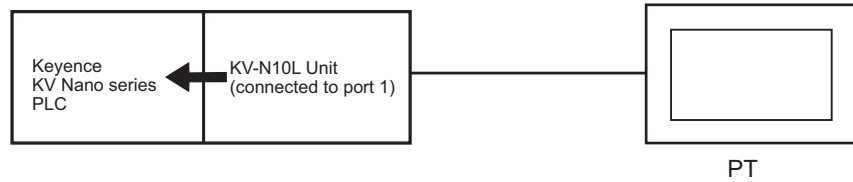

#### Connection Diagram

CPU	Unit	Connection diagram	PT																																						
KV Nano	KV-N10L	<p>D-sub 9-pin connector on KV-N10L</p> <table border="1"> <thead> <tr> <th>Pin No.</th> <th>Signal</th> </tr> </thead> <tbody> <tr><td>1</td><td>-</td></tr> <tr><td>2</td><td>RD</td></tr> <tr><td>3</td><td>SD</td></tr> <tr><td>4</td><td>-</td></tr> <tr><td>5</td><td>SG</td></tr> <tr><td>6</td><td>-</td></tr> <tr><td>7</td><td>RS</td></tr> <tr><td>8</td><td>CS</td></tr> <tr><td>9</td><td>-</td></tr> </tbody> </table> <p>To power supply</p> <table border="1"> <thead> <tr> <th>Pin No.</th> <th>Signal</th> </tr> </thead> <tbody> <tr><td>1</td><td>+</td></tr> <tr><td>2</td><td>-</td></tr> <tr><td>3</td><td>FG</td></tr> <tr><td>4</td><td>SD</td></tr> <tr><td>5</td><td>RD</td></tr> <tr><td>6</td><td>NC</td></tr> <tr><td>7</td><td>NC</td></tr> <tr><td>8</td><td>SG</td></tr> </tbody> </table> <p>PT</p>	Pin No.	Signal	1	-	2	RD	3	SD	4	-	5	SG	6	-	7	RS	8	CS	9	-	Pin No.	Signal	1	+	2	-	3	FG	4	SD	5	RD	6	NC	7	NC	8	SG	NV3W-V1, NV4W, or NV3Q for RS-232C
Pin No.	Signal																																								
1	-																																								
2	RD																																								
3	SD																																								
4	-																																								
5	SG																																								
6	-																																								
7	RS																																								
8	CS																																								
9	-																																								
Pin No.	Signal																																								
1	+																																								
2	-																																								
3	FG																																								
4	SD																																								
5	RD																																								
6	NC																																								
7	NC																																								
8	SG																																								

# SECTION 9

## Connecting to Hitachi PLCs

- 9-1 EH-150/EHV Series ..... 88
  - 9-1-1 RS-232C Connections ..... 90
  - 9-1-2 RS-422A Connections ..... 93
  - 9-1-3 RS-485 Connections ..... 94
- 9-2 MICRO-EH Series ..... 96
  - 9-2-1 RS-232C Connections ..... 97
- 9-3 Web Controller Series ..... 99
  - 9-3-1 RS-232C Connections ..... 100
  - 9-3-2 RS-422A Connections ..... 102
  - 9-3-3 RS-485 Connections ..... 103

## 9-1 EH-150/EHV Series

PLC Model Selection      Select Hitachi EH/EHV Series.

### Applicable Devices

Bit/word devices		No.	Comments
Bit devices	External inputs	X 0000 to X 4FF95	
	External outputs	Y 00000 to Y 4FF95	
	Internal outputs	R 000 to R FFF	
	Internal outputs	WR 0000.0 to WR FFFF.F	*1
	CPU links	L 00000 to L 73FFF	
	Internal outputs	WN 00000.0 to WN 1FFFF.F	*1
	Data area	M 00000 to M 7FFFF	
	Expansion external inputs	EX 00000 to EX 5A7FF	
	Expansion external outputs	EY 00000 to EY 5A7FF	
	ON-delay timers	TD 0000 to TD 2559	
	OFF-delay timers	TDN 0000 to TDN 2559	
	Single-shot bits	SS 0000 to SS 2559	
	Monostable timers	MS 0000 to MS 2559	
	Integral timer	TMR 0000 to TMR 2559	
	Watchdog timer	WDT 0000 to WTD 2559	
	Counters	CU 0000 to CU 2047	
	Ring counters	RCU 00000 to RCU 2047	
Up/down counters	CT 00000 to CT 2047		
Word devices	External inputs	WX 0000 to WX 4FF5	
	External outputs	WY 0000 to WY 4FF5	
	Internal outputs	WR 0000 to WR FFFF	
	CPU links	WL 0000 to WL 73FF	
	Internal outputs	WN 00000 to WN 1FFFF	
	Data area	WM 0000 to WM 7FFF	
	Expansion external inputs	WEX 0000 to WEX 5A7F	
	Expansion external outputs	WEY 0000 to WEY 5A7F	
	Timer/counter current values	TC 0000 to TC 2559	

\*1 Enter as follows from the NV-Designer:

$\frac{****}{\uparrow \text{Address}} \quad \frac{\cdot}{\uparrow \text{Period}} \quad \frac{*}{\uparrow \text{Bit position}}$

- Note**
- (1) The maximum values that can be set by the PT are given.
  - (2) The addressable memory ranges depend on the model of PLC that is used. Refer to the user manuals for your PLC for details.

**Communications Settings**      The following communications settings are recommended for the PT and PLC.

■ **PT Communications Settings (Set from the NV-Designer using the NV Configuration.)**

Item	Setting
Baud rate	19,200 bps
Data bits	7
Stop bits	1
Parity	Even

■ **PLC Communications Settings**

Applicable PLCs: EH-CPU104A, EH-CPU208A, EH-CPU316A, EH-CPU516, and EH-CPU548

**Using Port 1**

The DIP switch must be set and special internal outputs must be set. Set the DIP switch on the CPU Module as shown below.

Item	Setting
Port type	Special port setting
Baud rate	19,200 bps

Set the special internal outputs as shown below.

Item	Setting
Interface <sup>*1</sup>	RS-232C connection: RS-232C
	RS-422A connection: RS-422A, internal terminator ON
	RS-485 connection: RS-422A, internal terminator ON
Communications control procedure	Transmission control procedure 1 (no station numbers) <sup>*2</sup>

\*1 The interface depends on the communications method.

\*2 Transmission control procedure 1 cannot be used with station numbers.

\*3 Refer to the *EH-150 Application Manual* for the communications setting procedure.

**Using Port 2**

The DIP switch must be set and special internal outputs must be set. Always turn ON the PHL switch. Application is not possible if this switch is OFF. Set the DIP switch on the CPU Module as shown below.

Item	Setting
Port type	Special port setting <sup>*1</sup>
Baud rate	19,200 bps
Communications control procedure	Transmission control procedure 1 (no station numbers)

\*1 The port type cannot be changed, so it is not necessary to set it.

\*2 Refer to the *EH-150 Application Manual* for the communications setting procedure.

**Applicable PLCs: EHV-CPU128, EHV-CPU64, EHV-CPU32, and EHV-CPU16**

Settings must be made with the Programming Tool. Set the serial communications port as shown below using the Programming Tool.

Item	Setting
Type	Special port
Port type*1	RS-232C connection: RS-232C
	RS-422A connection: RS-422A/485
	RS-485 connection: RS-422A/485
Baud rate	19,200 bps
Communications procedure	Transmission control procedure 1 (no station numbers), 1:1 communications
Station number	None
Modem connection	None

\*1 The interface depends on the communications method.

\*2 Refer to the *Control Editor EH-150EH Series Ladder Programming Software Manual* for the communications setting procedure.

**Applicable PLC: EH-SIO (port 1 or 2)**

DIP switch settings and ladder program to make initial settings are required. Set the port DIP switch as follows:

Item	Setting
Baud rate	19,200 bps
Data length	7
Parity	Even
Stop bits	1

Set the EH-SIO communications port from the ladder program as follows:

Item	Setting
Initial communications mode	Hi-Protocol mode
Communications procedure	Transmission control procedure 1 (no station numbers)
Station number	None

**Note** Refer to the *EH-SIO Application Manual* for the communications setting procedure.

**9-1-1 RS-232C Connections**

Connecting to the EH-RS05 with a user-made cable.

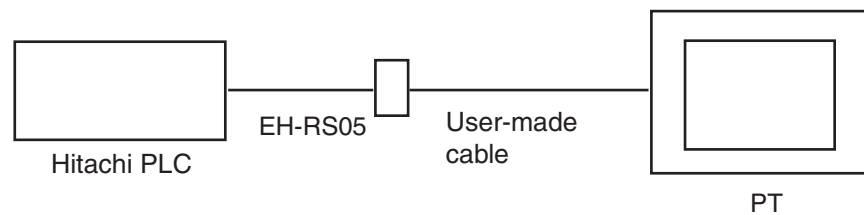



■ Connection Diagram

CPU	Link interface	Connection diagram	PT																																																		
EH-CPU104A EH-CPU208A EH-CPU316A EH-CPU516 EH-CPU548	Port 1 or 2 on CPU Module	D-sub 15-pin male connector on cable <table border="1" style="display: inline-table; margin-right: 20px;"> <thead> <tr> <th>Pin No.</th> <th>Signal</th> </tr> </thead> <tbody> <tr><td>1</td><td>-</td></tr> <tr><td>2</td><td>SD</td></tr> <tr><td>3</td><td>RD</td></tr> <tr><td>4</td><td>RS</td></tr> <tr><td>5</td><td>CS</td></tr> <tr><td>6</td><td>-</td></tr> <tr><td>7</td><td>DR</td></tr> <tr><td>8</td><td>-</td></tr> <tr><td>9</td><td>PG</td></tr> <tr><td>10</td><td>PG</td></tr> <tr><td>11</td><td>CD</td></tr> <tr><td>12</td><td>CD</td></tr> <tr><td>13</td><td>ER1</td></tr> <tr><td>14</td><td>ER2</td></tr> <tr><td>15</td><td>-</td></tr> </tbody> </table> <table border="1" style="display: inline-table;"> <thead> <tr> <th>Pin No.</th> <th>Signal</th> </tr> </thead> <tbody> <tr><td>1</td><td>+</td></tr> <tr><td>2</td><td>-</td></tr> <tr><td>3</td><td>FG</td></tr> <tr><td>4</td><td>SD</td></tr> <tr><td>5</td><td>RD</td></tr> <tr><td>6</td><td>NC</td></tr> <tr><td>7</td><td>NC</td></tr> <tr><td>8</td><td>SG</td></tr> </tbody> </table>	Pin No.	Signal	1	-	2	SD	3	RD	4	RS	5	CS	6	-	7	DR	8	-	9	PG	10	PG	11	CD	12	CD	13	ER1	14	ER2	15	-	Pin No.	Signal	1	+	2	-	3	FG	4	SD	5	RD	6	NC	7	NC	8	SG	NV3W (-V1), NV4W, or NV3Q for RS-232C
Pin No.	Signal																																																				
1	-																																																				
2	SD																																																				
3	RD																																																				
4	RS																																																				
5	CS																																																				
6	-																																																				
7	DR																																																				
8	-																																																				
9	PG																																																				
10	PG																																																				
11	CD																																																				
12	CD																																																				
13	ER1																																																				
14	ER2																																																				
15	-																																																				
Pin No.	Signal																																																				
1	+																																																				
2	-																																																				
3	FG																																																				
4	SD																																																				
5	RD																																																				
6	NC																																																				
7	NC																																																				
8	SG																																																				
EHV-CPU128 EHV-CPU64 EHV-CPU32 EHV-CPU16	Serial port on CPU Module		NV3W (-V1), NV4W, or NV3Q for RS-232C																																																		

**Note** Settings depend on the port and communications method. Check the communications settings given previously.

Using the EH-SIO Unit and Connecting to the EH-RS05 with a User-made Cable

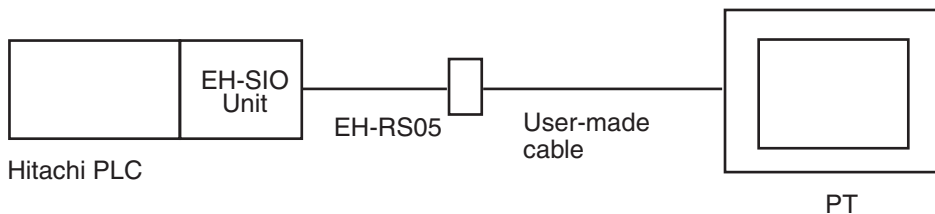

■ Connection Diagram

CPU	Link interface	Connection diagram	PT																																																		
EH-CPU104A EH-CPU208A EH-CPU316A EH-CPU516 EH-CPU548	Port 1 or 2 on EH-SIO	D-sub 15-pin male connector on cable <table border="1" style="display: inline-table; margin-right: 20px;"> <thead> <tr> <th>Pin No.</th> <th>Signal</th> </tr> </thead> <tbody> <tr><td>1</td><td>-</td></tr> <tr><td>2</td><td>SD</td></tr> <tr><td>3</td><td>RD</td></tr> <tr><td>4</td><td>RS</td></tr> <tr><td>5</td><td>CS</td></tr> <tr><td>6</td><td>-</td></tr> <tr><td>7</td><td>DR</td></tr> <tr><td>8</td><td>-</td></tr> <tr><td>9</td><td>PG</td></tr> <tr><td>10</td><td>PG</td></tr> <tr><td>11</td><td>CD</td></tr> <tr><td>12</td><td>CD</td></tr> <tr><td>13</td><td>ER1</td></tr> <tr><td>14</td><td>ER2</td></tr> <tr><td>15</td><td>-</td></tr> </tbody> </table> <table border="1" style="display: inline-table;"> <thead> <tr> <th>Pin No.</th> <th>Signal</th> </tr> </thead> <tbody> <tr><td>1</td><td>+</td></tr> <tr><td>2</td><td>-</td></tr> <tr><td>3</td><td>FG</td></tr> <tr><td>4</td><td>SD</td></tr> <tr><td>5</td><td>RD</td></tr> <tr><td>6</td><td>NC</td></tr> <tr><td>7</td><td>NC</td></tr> <tr><td>8</td><td>SG</td></tr> </tbody> </table>	Pin No.	Signal	1	-	2	SD	3	RD	4	RS	5	CS	6	-	7	DR	8	-	9	PG	10	PG	11	CD	12	CD	13	ER1	14	ER2	15	-	Pin No.	Signal	1	+	2	-	3	FG	4	SD	5	RD	6	NC	7	NC	8	SG	NV3W (-V1), NV4W, or NV3Q for RS-232C
Pin No.			Signal																																																		
1	-																																																				
2	SD																																																				
3	RD																																																				
4	RS																																																				
5	CS																																																				
6	-																																																				
7	DR																																																				
8	-																																																				
9	PG																																																				
10	PG																																																				
11	CD																																																				
12	CD																																																				
13	ER1																																																				
14	ER2																																																				
15	-																																																				
Pin No.	Signal																																																				
1	+																																																				
2	-																																																				
3	FG																																																				
4	SD																																																				
5	RD																																																				
6	NC																																																				
7	NC																																																				
8	SG																																																				
EHV-CPU128 EHV-CPU64 EHV-CPU32 EHV-CPU16			NV3W (-V1), NV4W, or NV3Q for RS-232C																																																		

**Note** Settings depend on the port and communications method. Check the communications settings given previously.

**Connecting Using an RJ45 Connector and User-made Cable**

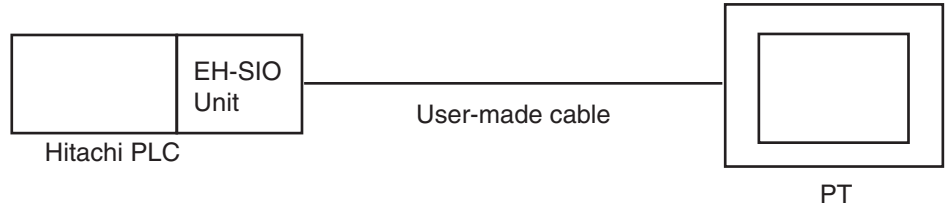

**RJ45 Modular Port**

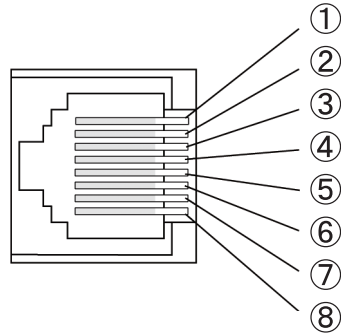

**Note** Circled numbers 1 to 8 are the pin numbers of the RJ45 Connector in the connection diagram.

**■ Connection Diagram (Socket Side of Port 1 Viewed from Front of Module)**

CPU	Link interface	Connection diagram		PT																																				
EH-CPU104A EH-CPU208A EH-CPU316A EH-CPU516 EH-CPU548	Port 1 or 2 on CPU Module	RJ45 Connector on Hitachi PLC 		NV3W (-V1), NV4W, or NV3Q for RS-232C																																				
EHV-CPU128 EHV-CPU64 EHV-CPU32 EHV-CPU16	CPU Unit serial port	<table border="1"> <thead> <tr> <th>Pin No.</th> <th>Signal</th> </tr> </thead> <tbody> <tr><td>1</td><td>SG</td></tr> <tr><td>2</td><td>CD</td></tr> <tr><td>3</td><td>ER1</td></tr> <tr><td>4</td><td>ER2</td></tr> <tr><td>5</td><td>SD</td></tr> <tr><td>6</td><td>RD</td></tr> <tr><td>7</td><td>DR</td></tr> <tr><td>8</td><td>RS</td></tr> </tbody> </table>	Pin No.	Signal	1	SG	2	CD	3	ER1	4	ER2	5	SD	6	RD	7	DR	8	RS	<table border="1"> <thead> <tr> <th>Pin No.</th> <th>Signal</th> </tr> </thead> <tbody> <tr><td>1</td><td>+</td></tr> <tr><td>2</td><td>-</td></tr> <tr><td>3</td><td>FG</td></tr> <tr><td>4</td><td>SD</td></tr> <tr><td>5</td><td>RD</td></tr> <tr><td>6</td><td>NC</td></tr> <tr><td>7</td><td>NC</td></tr> <tr><td>8</td><td>SG</td></tr> </tbody> </table>	Pin No.	Signal	1	+	2	-	3	FG	4	SD	5	RD	6	NC	7	NC	8	SG	NV3W (-V1), NV4W, or NV3Q for RS-232C
Pin No.	Signal																																							
1	SG																																							
2	CD																																							
3	ER1																																							
4	ER2																																							
5	SD																																							
6	RD																																							
7	DR																																							
8	RS																																							
Pin No.	Signal																																							
1	+																																							
2	-																																							
3	FG																																							
4	SD																																							
5	RD																																							
6	NC																																							
7	NC																																							
8	SG																																							

**Note** Settings depend on the port and communications method. Check the communications settings given previously.

**Using the EH-SIO Unit and Connecting with a User-made Cable with the RJ45 Connector**

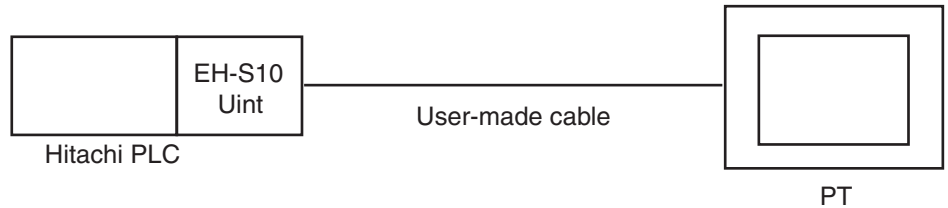

**■ Connection Diagram**

Refer to the previous RJ45 Modular Port diagram for the pin numbers for the RJ45 Connector.

CPU	Link interface	Connection diagram	PT
EH-CPU104A EH-CPU208A EH-CPU316A EH-CPU516 EH-CPU548	Port 1 or 2 on EH-SIO	RJ45 Connector on Hitachi PLC 	NV3W (-V1), NV4W, or NV3Q for RS-232C
EHV-CPU128 EHV-CPU64 EHV-CPU32 EHV-CPU16			NV3W (-V1), NV4W, or NV3Q for RS-232C

**Note** Settings depend on the port and communications method. Check the communications settings given previously.

**9-1-2 RS-422A Connections**

**Connecting with a User-made Cable**

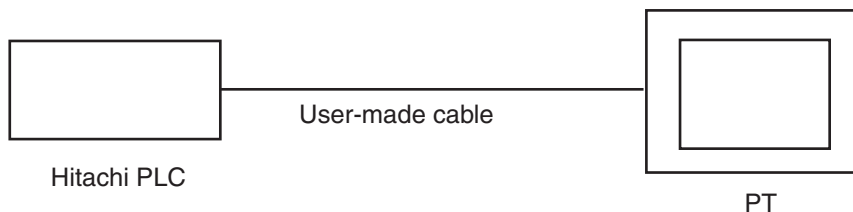

**■ Connection Diagram**

Refer to the previous RJ45 Modular Port diagram for the pin numbers for the RJ45 Connector.

CPU	Link interface	Connection diagram	PT
EH-CPU104A EH-CPU208A EH-CPU316A EH-CPU516 EH-CPU548	Port 1 on CPU Module	RJ45 Connector on CPU Module Port (RS-422) on Hitachi PLC 	NV3W (-V1), NV4W, or NV3Q for RS-422A
EHV-CPU128 EHV-CPU64 EHV-CPU32 EHV-CPU16	CPU Unit serial port		NV3W (-V1), NV4W, or NV3Q for RS-422A

**Note** Settings depend on the port and communications method. Check the communications settings given previously.

**Using the EH-SIO Unit and Connecting with a User-made Cable**

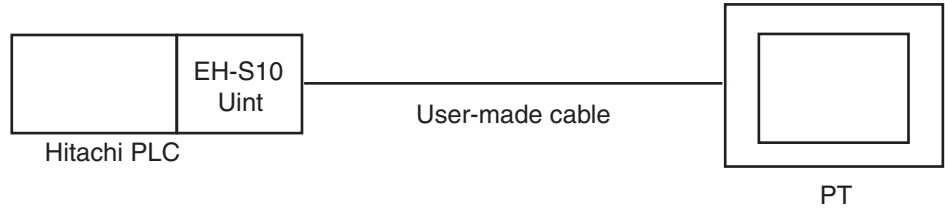

**■ Connection Diagram**

CPU	Link interface	Connection diagram	PT
EH-CPU104A EH-CPU208A EH-CPU316A EH-CPU516 EH-CPU548	Port 2 on EH-SIO RS-422A/485 connector	RS-422/485 Connector on CPU Module Port (RS-422) on Hitachi PLC 	NV3W (-V1), NV4W, or NV3Q for RS-422A
EHV-CPU128 EHV-CPU64 EHV-CPU32 EHV-CPU16			NV3W (-V1), NV4W, or NV3Q for RS-422A

**Note** Settings depend on the port and communications method. Check the communications settings given previously.

**9-1-3 RS-485 Connections**

**RS-485 Connections**

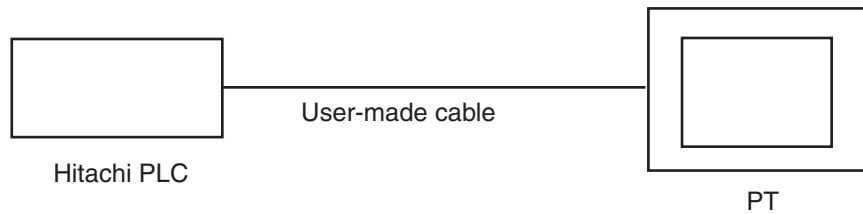

**■ Connection Diagram**

Refer to the previous RJ45 Modular Port diagram for the pin numbers for the RJ45 Connector.

CPU	Link interface	Connection diagram	PT
EH-CPU104A EH-CPU208A EH-CPU316A EH-CPU516 EH-CPU548	Port 1 on CPU Module	RJ45 Connector on CPU Module Port (RS-485) on Hitachi PLC 	NV3W (-V1), NV4W, or NV3Q for RS-485
EHV-CPU128 EHV-CPU64 EHV-CPU32 EHV-CPU16	CPU Unit serial port		NV3W (-V1), NV4W, or NV3Q for RS-485

**Note** Settings depend on the port and communications method. Check the communications settings given previously.

**Using the EH-SIO Unit and Connecting with a User-made Cable**

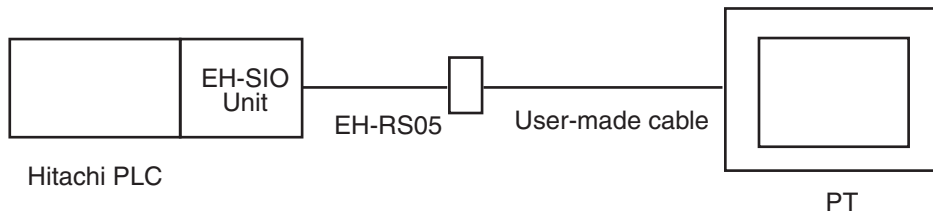

■ Connection Diagram

CPU	Link interface	Connection diagram	PT																																
EH-CPU104A EH-CPU208A EH-CPU316A EH-CPU516 EH-CPU548	Port 2 on EH-SIO RS-422A/485 connector	RS-422/485 Connector on CPU Module Port (RS-422) on Hitachi PLC	NV3W (-V1), NV4W, or NV3Q for RS-485																																
EHV-CPU128 EHV-CPU64 EHV-CPU32 EHV-CPU16		<table border="1"> <thead> <tr> <th>Pin No.</th> <th>Signal</th> </tr> </thead> <tbody> <tr><td>1</td><td>SD+</td></tr> <tr><td>2</td><td>SD-</td></tr> <tr><td>3</td><td>RD+</td></tr> <tr><td>4</td><td>RD-</td></tr> <tr><td>5</td><td>TERM</td></tr> <tr><td>6</td><td>SG</td></tr> </tbody> </table> <table border="1"> <thead> <tr> <th>Pin No.</th> <th>Signal</th> </tr> </thead> <tbody> <tr><td>1</td><td>+</td></tr> <tr><td>2</td><td>-</td></tr> <tr><td>3</td><td>FG</td></tr> <tr><td>4</td><td>+SD</td></tr> <tr><td>5</td><td>-SD</td></tr> <tr><td>6</td><td>+RD</td></tr> <tr><td>7</td><td>-RD</td></tr> <tr><td>8</td><td>Terminator setting (built-in 120 Ω resistance)</td></tr> </tbody> </table>	Pin No.	Signal	1	SD+	2	SD-	3	RD+	4	RD-	5	TERM	6	SG	Pin No.	Signal	1	+	2	-	3	FG	4	+SD	5	-SD	6	+RD	7	-RD	8	Terminator setting (built-in 120 Ω resistance)	NV3W (-V1), NV4W, or NV3Q for RS-485
Pin No.	Signal																																		
1	SD+																																		
2	SD-																																		
3	RD+																																		
4	RD-																																		
5	TERM																																		
6	SG																																		
Pin No.	Signal																																		
1	+																																		
2	-																																		
3	FG																																		
4	+SD																																		
5	-SD																																		
6	+RD																																		
7	-RD																																		
8	Terminator setting (built-in 120 Ω resistance)																																		

**Note** Settings depend on the port and communications method. Check the communications settings given previously.

## 9-2 MICRO-EH Series

PLC Model Selection      Select Hitachi EH/EHV Series.

### Applicable Devices

Bit/word devices		No.	Comments
Bit devices	External inputs	X 0000 to X 4FF95	
	External outputs	Y 00000 to Y 4FF95	
	Internal outputs	R 000 to R FFF	
	Internal outputs	WR 0000.0 to WR FFFF.F	*1
	CPU links	L 00000 to L 73FFF	
	Internal outputs	WN 00000.0 to WN 1FFFF.F	*1
	Data area	M 00000 to M 7FFFF	
	Expansion external inputs	EX 00000 to EX 5A7FF	
	Expansion external outputs	EY 00000 to EY 5A7FF	
	ON-delay timers	TD 0000 to TD 2559	
	OFF-delay timers	TDN 0000 to TDN 2559	
	Single-shot bits	SS 0000 to SS 2559	
	Monostable timers	MS 0000 to MS 2559	
	Integral timer	TMR 0000 to TMR 2559	
	Watchdog timer	WDT 0000 to WTD 2559	
	Counters	CU 0000 to CU 2047	
	Ring counters	RCU 00000 to RCU 2047	
Up/down counters	CT 00000 to CT 2047		
Word devices	External inputs	WX 0000 to WX 4FF5	
	External outputs	WY 0000 to WY 4FF5	
	Internal outputs	WR 0000 to WR FFFF	
	CPU links	WL 0000 to WL 73FF	
	Internal outputs	WN 00000 to WN 1FFFF	
	Data area	WM 0000 to WM 7FFF	
	Expansion external inputs	WEX 0000 to WEX 5A7F	
	Expansion external outputs	WEY 0000 to WEY 5A7F	
	Timer/counter current values	TC 0000 to TC 2559	

\*1 Enter as follows from the NV-Designer:  $\frac{****}{\text{Address}} \frac{\cdot}{\text{Period}} \frac{*}{\text{Bit position}}$

- Note**
- (1) The maximum values that can be set by the PT are given.
  - (2) The addressable memory ranges depend on the model of PLC that is used. Refer to the user manuals for your PLC for details.

**Communications Settings**      The following communications settings are recommended for the PT and PLC.

■ PT Communications Settings (Set from the NV-Designer using the NV Configuration.)

Item	Setting
Baud rate	19,200 bps
Data bits	7
Stop bits	1
Parity	Even

■ PLC Communications Settings

The DIP switch and special internal outputs must be set. Make the following settings.

Item	Setting
Port type	Special port
Communications control procedure	Transmission control procedure 1 (no station numbers)
Baud rate	19,200 bps

### 9-2-1 RS-232C Connections

Connecting to the EH-RS05 with a user-made cable.

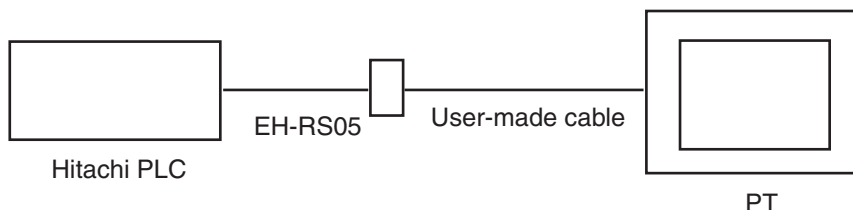

■ Connection Diagram

PLC type	Link interface	Connection diagram	PT																																																		
MICRO-EH Series 14 points 20 points 23 points 28 points 40 points 64 points	Port 1 on CPU Module	<p>D-sub 15-pin male connector on cable</p> <table border="1"> <thead> <tr> <th>Pin No.</th> <th>Signal</th> </tr> </thead> <tbody> <tr><td>1</td><td>-</td></tr> <tr><td>2</td><td>SD</td></tr> <tr><td>3</td><td>RD</td></tr> <tr><td>4</td><td>RS</td></tr> <tr><td>5</td><td>CS</td></tr> <tr><td>6</td><td>-</td></tr> <tr><td>7</td><td>DR</td></tr> <tr><td>8</td><td>-</td></tr> <tr><td>9</td><td>PG</td></tr> <tr><td>10</td><td>PG</td></tr> <tr><td>11</td><td>CD</td></tr> <tr><td>12</td><td>CD</td></tr> <tr><td>13</td><td>ER1</td></tr> <tr><td>14</td><td>ER2</td></tr> <tr><td>15</td><td>-</td></tr> </tbody> </table> <p>To power supply</p> <table border="1"> <thead> <tr> <th>Pin No.</th> <th>Signal</th> </tr> </thead> <tbody> <tr><td>1</td><td>+</td></tr> <tr><td>2</td><td>-</td></tr> <tr><td>3</td><td>FG</td></tr> <tr><td>4</td><td>SD</td></tr> <tr><td>5</td><td>RD</td></tr> <tr><td>6</td><td>NC</td></tr> <tr><td>7</td><td>NC</td></tr> <tr><td>8</td><td>SG</td></tr> </tbody> </table>	Pin No.	Signal	1	-	2	SD	3	RD	4	RS	5	CS	6	-	7	DR	8	-	9	PG	10	PG	11	CD	12	CD	13	ER1	14	ER2	15	-	Pin No.	Signal	1	+	2	-	3	FG	4	SD	5	RD	6	NC	7	NC	8	SG	NV3W (-V1), NV4W, or NV3Q for RS-232C
Pin No.	Signal																																																				
1	-																																																				
2	SD																																																				
3	RD																																																				
4	RS																																																				
5	CS																																																				
6	-																																																				
7	DR																																																				
8	-																																																				
9	PG																																																				
10	PG																																																				
11	CD																																																				
12	CD																																																				
13	ER1																																																				
14	ER2																																																				
15	-																																																				
Pin No.	Signal																																																				
1	+																																																				
2	-																																																				
3	FG																																																				
4	SD																																																				
5	RD																																																				
6	NC																																																				
7	NC																																																				
8	SG																																																				

- Note**
- (1) Settings depend on the port and communications method. Check the communications settings given previously.
  - (2) The model with 10 points cannot be used.

**Connecting Using an RH45 Connector and User-made Cable**

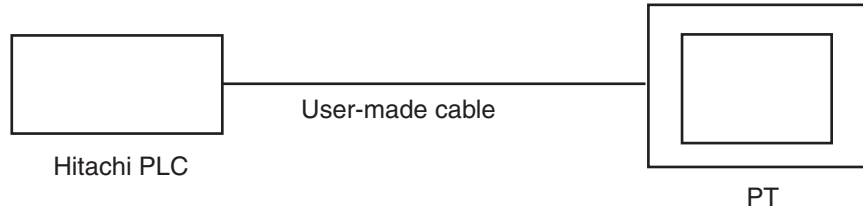

**RJ45 Modular Port**

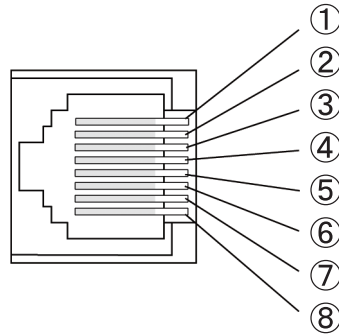

**Note** Circled numbers 1 to 8 are the pin numbers of the RJ45 Connector in the connection diagram.

**■ Connection Diagram (Socket Side of Port 1 Viewed from Front of Module)**

PLC type	Link interface	Connection diagram		PT																																				
MICRO-EH Series 14 points 20 points 23 points 28 points 40 points 64 points	Port 1 on CPU Module	<p>RJ45 Connector on Hitachi PLC</p> <table border="1"> <thead> <tr> <th>Pin No.</th> <th>Signal</th> </tr> </thead> <tbody> <tr><td>1</td><td>SG</td></tr> <tr><td>2</td><td>CD</td></tr> <tr><td>3</td><td>ER1</td></tr> <tr><td>4</td><td>ER2</td></tr> <tr><td>5</td><td>SD</td></tr> <tr><td>6</td><td>RD</td></tr> <tr><td>7</td><td>DR</td></tr> <tr><td>8</td><td>RS</td></tr> </tbody> </table> <p>To power supply</p> <p>PT</p> <table border="1"> <thead> <tr> <th>Pin No.</th> <th>Signal</th> </tr> </thead> <tbody> <tr><td>1</td><td>+</td></tr> <tr><td>2</td><td>-</td></tr> <tr><td>3</td><td>FG</td></tr> <tr><td>4</td><td>SD</td></tr> <tr><td>5</td><td>RD</td></tr> <tr><td>6</td><td>NC</td></tr> <tr><td>7</td><td>NC</td></tr> <tr><td>8</td><td>SG</td></tr> </tbody> </table>		Pin No.	Signal	1	SG	2	CD	3	ER1	4	ER2	5	SD	6	RD	7	DR	8	RS	Pin No.	Signal	1	+	2	-	3	FG	4	SD	5	RD	6	NC	7	NC	8	SG	NV3W (-V1), NV4W, or NV3Q for RS-232C
Pin No.	Signal																																							
1	SG																																							
2	CD																																							
3	ER1																																							
4	ER2																																							
5	SD																																							
6	RD																																							
7	DR																																							
8	RS																																							
Pin No.	Signal																																							
1	+																																							
2	-																																							
3	FG																																							
4	SD																																							
5	RD																																							
6	NC																																							
7	NC																																							
8	SG																																							

**Note** (1) Settings depend on the port and communications method. Check the communications settings given previously.  
 (2) The model with 10 points cannot be used.



## 9-3 Web Controller Series

PLC Model Selection      Select Hitachi EH/EHV Series.

### Applicable Devices

Bit/word devices		No.	Comments
Bit devices	External inputs	X 0000 to X 4FF95	
	External outputs	Y 00000 to Y 4FF95	
	Internal outputs	R 000 to R FFF	
	Internal outputs	WR 0000.0 to WR FFFF.F	*1
	CPU links	L 00000 to L 73FFF	
	Internal outputs	WN 00000.0 to WN 1FFFF.F	*1
	Data area	M 00000 to M 7FFFF	
	Expansion external inputs	EX 00000 to EX 5A7FF	
	Expansion external outputs	EY 00000 to EY 5A7FF	
	ON-delay timers	TD 0000 to TD 2559	
	OFF-delay timers	TDN 0000 to TDN 2559	
	Single-shot bits	SS 0000 to SS 2559	
	Monostable timers	MS 0000 to MS 2559	
	Integral timer	TMR 0000 to TMR 2559	
	Watchdog timer	WDT 0000 to WTD 2559	
	Counters	CU 0000 to CU 2047	
	Ring counters	RCU 00000 to RCU 2047	
	Up/down counters	CT 00000 to CT 2047	
Word devices	External inputs	WX 0000 to WX 4FF5	
	External outputs	WY 0000 to WY 4FF5	
	Internal outputs	WR 0000 to WR FFFF	
	CPU links	WL 0000 to WL 73FF	
	Internal outputs	WN 00000 to WN 1FFFF	
	Data area	WM 0000 to WM 7FFF	
	Expansion external inputs	WEX 0000 to WEX 5A7F	
	Expansion external outputs	WEY 0000 to WEY 5A7F	
	Timer/counter current values	TC 0000 to TC 2559	

\*1 Enter as follows from the NV-Designer:  $\frac{****}{\text{Address}} \frac{\cdot}{\text{Period}} \frac{*}{\text{Bit position}}$

- Note**
- (1) The maximum values that can be set by the PT are given.
  - (2) The addressable memory ranges depend on the model of PLC that is used. Refer to the user manuals for your PLC for details.

**Communications Settings** The following communications settings are recommended for the PT and PLC.

■ **PT Communications Settings (Set from the NV-Designer using the NV Configuration.)**

Item	Setting
Baud rate	19,200 bps
Data bits	7
Stop bits	1
Parity	Even

■ **PLC Communications Settings**

**Web Controller Serial Port Settings**

To set the serial port, start a Web browser on your computer and access the System Configurator page in the Web Controller. Make the following settings.

Item	Setting
Protocol	Passive-HIPROTOCOL
Interface*1	RS-232C: RS-232C
	RS-422A: RS-422A/RS-485
	RS-485: RS-422A/RS-485
Communications control procedure	Transmission control procedure 1 (no station numbers), 1:1 communications
Baud rate	19,200 bps

\*1 The interface depends on the communications method.

\*2 Refer to the *Web Controller User Manual* for the communications setting procedure.

**9-3-1 RS-232C Connections**

Connecting to the EH-RS05 with a user-made cable.

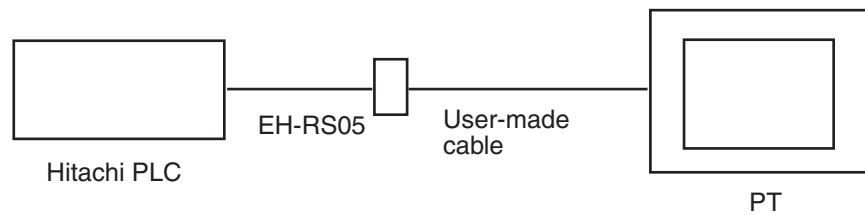

■ Connection Diagram

PLC type	Link interface	Connection diagram	PT																																																		
10 points (EH-WD10DR) 23 points (EH-WD23DR)	CPU Unit serial port	<p>D-sub 15-pin male connector on cable</p> <table border="1"> <thead> <tr> <th>Pin No.</th> <th>Signal</th> </tr> </thead> <tbody> <tr><td>1</td><td>-</td></tr> <tr><td>2</td><td>SD</td></tr> <tr><td>3</td><td>RD</td></tr> <tr><td>4</td><td>RS</td></tr> <tr><td>5</td><td>CS</td></tr> <tr><td>6</td><td>-</td></tr> <tr><td>7</td><td>DR</td></tr> <tr><td>8</td><td>-</td></tr> <tr><td>9</td><td>PG</td></tr> <tr><td>10</td><td>PG</td></tr> <tr><td>11</td><td>CD</td></tr> <tr><td>12</td><td>CD</td></tr> <tr><td>13</td><td>ER1</td></tr> <tr><td>14</td><td>ER2</td></tr> <tr><td>15</td><td>-</td></tr> </tbody> </table> <table border="1"> <thead> <tr> <th>Pin No.</th> <th>Signal</th> </tr> </thead> <tbody> <tr><td>1</td><td>+</td></tr> <tr><td>2</td><td>-</td></tr> <tr><td>3</td><td>FG</td></tr> <tr><td>4</td><td>SD</td></tr> <tr><td>5</td><td>RD</td></tr> <tr><td>6</td><td>NC</td></tr> <tr><td>7</td><td>NC</td></tr> <tr><td>8</td><td>SG</td></tr> </tbody> </table>	Pin No.	Signal	1	-	2	SD	3	RD	4	RS	5	CS	6	-	7	DR	8	-	9	PG	10	PG	11	CD	12	CD	13	ER1	14	ER2	15	-	Pin No.	Signal	1	+	2	-	3	FG	4	SD	5	RD	6	NC	7	NC	8	SG	NV3W (-V1), NV4W, or NV3Q for RS-232C
Pin No.	Signal																																																				
1	-																																																				
2	SD																																																				
3	RD																																																				
4	RS																																																				
5	CS																																																				
6	-																																																				
7	DR																																																				
8	-																																																				
9	PG																																																				
10	PG																																																				
11	CD																																																				
12	CD																																																				
13	ER1																																																				
14	ER2																																																				
15	-																																																				
Pin No.	Signal																																																				
1	+																																																				
2	-																																																				
3	FG																																																				
4	SD																																																				
5	RD																																																				
6	NC																																																				
7	NC																																																				
8	SG																																																				

**Note** Settings depend on the port and communications method. Check the communications settings given previously.

**Connecting Using an RJ45 Connector and User-made Cable**

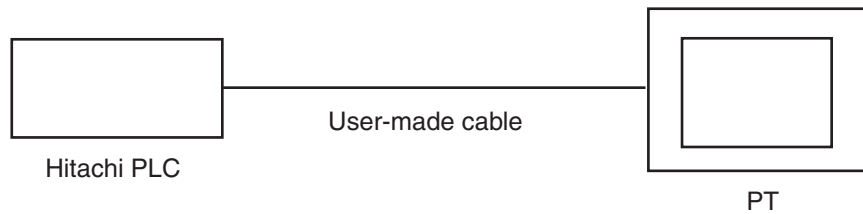

**RJ45 Modular Port**

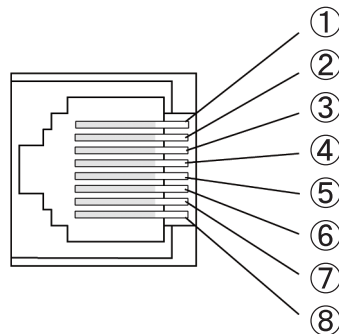

**Note** Circled numbers 1 to 8 are the pin numbers of the RJ45 Connector in the connection diagram.

■ Connection Diagram (Socket Side of Port 1 Viewed from Front of Module)

PLC type	Link interface	Connection diagram	PT																																				
10 points (EH-WD10DR) 23 points (EH-WD23DR)	CPU Unit serial port	<p>RJ45 Connector on Hitachi PLC</p> <table border="1"> <thead> <tr> <th>Pin No.</th> <th>Signal</th> </tr> </thead> <tbody> <tr><td>1</td><td>SG</td></tr> <tr><td>2</td><td>CD</td></tr> <tr><td>3</td><td>ER1</td></tr> <tr><td>4</td><td>ER2</td></tr> <tr><td>5</td><td>SD</td></tr> <tr><td>6</td><td>RD</td></tr> <tr><td>7</td><td>DR</td></tr> <tr><td>8</td><td>RS</td></tr> </tbody> </table> <table border="1"> <thead> <tr> <th>Pin No.</th> <th>Signal</th> </tr> </thead> <tbody> <tr><td>1</td><td>+</td></tr> <tr><td>2</td><td>-</td></tr> <tr><td>3</td><td>FG</td></tr> <tr><td>4</td><td>SD</td></tr> <tr><td>5</td><td>RD</td></tr> <tr><td>6</td><td>NC</td></tr> <tr><td>7</td><td>NC</td></tr> <tr><td>8</td><td>SG</td></tr> </tbody> </table>	Pin No.	Signal	1	SG	2	CD	3	ER1	4	ER2	5	SD	6	RD	7	DR	8	RS	Pin No.	Signal	1	+	2	-	3	FG	4	SD	5	RD	6	NC	7	NC	8	SG	NV3W (-V1), NV4W, or NV3Q for RS-232C
Pin No.	Signal																																						
1	SG																																						
2	CD																																						
3	ER1																																						
4	ER2																																						
5	SD																																						
6	RD																																						
7	DR																																						
8	RS																																						
Pin No.	Signal																																						
1	+																																						
2	-																																						
3	FG																																						
4	SD																																						
5	RD																																						
6	NC																																						
7	NC																																						
8	SG																																						

9-3-2 RS-422A Connections

Connecting Using an RJ45 Connector and User-made Cable

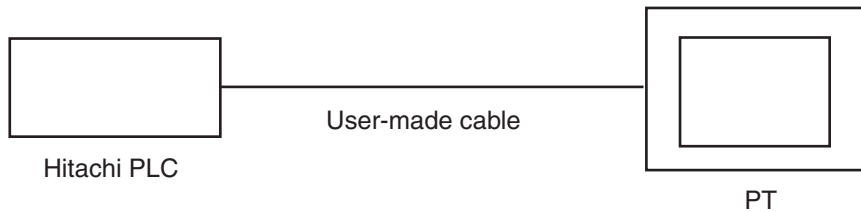

■ Connection Diagram

Refer to the previous RJ45 Modular Port diagram for the pin numbers for the RJ45 Connector.

PLC type	Link interface	Connection diagram	PT																																				
10 points (EH-WD10DR) 23 points (EH-WD23DR)	CPU Unit serial port	<p>RJ45 Connector on CPU Module Port (RS-422) on Hitachi PLC</p> <table border="1"> <thead> <tr> <th>Pin No.</th> <th>Signal</th> </tr> </thead> <tbody> <tr><td>1</td><td>SG</td></tr> <tr><td>2</td><td>-</td></tr> <tr><td>3</td><td>-</td></tr> <tr><td>4</td><td>SD+</td></tr> <tr><td>5</td><td>SD-</td></tr> <tr><td>6</td><td>RD-</td></tr> <tr><td>7</td><td>RD+</td></tr> <tr><td>8</td><td>-</td></tr> </tbody> </table> <table border="1"> <thead> <tr> <th>Pin No.</th> <th>Signal</th> </tr> </thead> <tbody> <tr><td>1</td><td>+</td></tr> <tr><td>2</td><td>-</td></tr> <tr><td>3</td><td>FG</td></tr> <tr><td>4</td><td>+SD</td></tr> <tr><td>5</td><td>-SD</td></tr> <tr><td>6</td><td>+RD</td></tr> <tr><td>7</td><td>-RD</td></tr> <tr><td>8</td><td>Terminator setting (built-in 120 Ω resistance)</td></tr> </tbody> </table>	Pin No.	Signal	1	SG	2	-	3	-	4	SD+	5	SD-	6	RD-	7	RD+	8	-	Pin No.	Signal	1	+	2	-	3	FG	4	+SD	5	-SD	6	+RD	7	-RD	8	Terminator setting (built-in 120 Ω resistance)	NV3W (-V1), NV4W, or NV3Q for RS-422A
Pin No.	Signal																																						
1	SG																																						
2	-																																						
3	-																																						
4	SD+																																						
5	SD-																																						
6	RD-																																						
7	RD+																																						
8	-																																						
Pin No.	Signal																																						
1	+																																						
2	-																																						
3	FG																																						
4	+SD																																						
5	-SD																																						
6	+RD																																						
7	-RD																																						
8	Terminator setting (built-in 120 Ω resistance)																																						

### 9-3-3 RS-485 Connections

Connecting Using an RJ45 Connector and User-made Cable

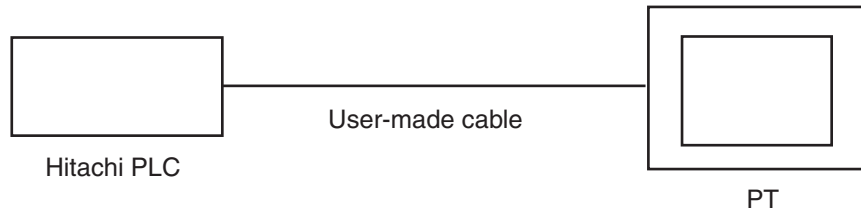

■ Connection Diagram

Refer to the previous RJ45 Modular Port diagram for the pin numbers for the RJ45 Connector.

PLC type	Link interface	Connection diagram	PT																																				
23 points (EH-WD23DR)	CPU Unit serial port	<p>RJ45 Connector on CPU Module Port (RS-485) on Hitachi PLC</p> <table border="1" style="display: inline-table; margin-right: 20px;"> <thead> <tr> <th>Pin No.</th> <th>Signal</th> </tr> </thead> <tbody> <tr><td>1</td><td>SG</td></tr> <tr><td>2</td><td>-</td></tr> <tr><td>3</td><td>-</td></tr> <tr><td>4</td><td>SD+</td></tr> <tr><td>5</td><td>SD-</td></tr> <tr><td>6</td><td>RD-</td></tr> <tr><td>7</td><td>RD+</td></tr> <tr><td>8</td><td>-</td></tr> </tbody> </table> <p style="margin-left: 20px;">To power supply</p> <table border="1" style="display: inline-table;"> <thead> <tr> <th>Pin No.</th> <th>Signal</th> </tr> </thead> <tbody> <tr><td>1</td><td>+</td></tr> <tr><td>2</td><td>-</td></tr> <tr><td>3</td><td>FG</td></tr> <tr><td>4</td><td>+SD</td></tr> <tr><td>5</td><td>-SD</td></tr> <tr><td>6</td><td>+RD</td></tr> <tr><td>7</td><td>-RD</td></tr> <tr><td>8</td><td>Terminator setting (built-in 120 Ω resistance)</td></tr> </tbody> </table>	Pin No.	Signal	1	SG	2	-	3	-	4	SD+	5	SD-	6	RD-	7	RD+	8	-	Pin No.	Signal	1	+	2	-	3	FG	4	+SD	5	-SD	6	+RD	7	-RD	8	Terminator setting (built-in 120 Ω resistance)	NV3W (-V1), NV4W, or NV3Q for RS-485
Pin No.	Signal																																						
1	SG																																						
2	-																																						
3	-																																						
4	SD+																																						
5	SD-																																						
6	RD-																																						
7	RD+																																						
8	-																																						
Pin No.	Signal																																						
1	+																																						
2	-																																						
3	FG																																						
4	+SD																																						
5	-SD																																						
6	+RD																																						
7	-RD																																						
8	Terminator setting (built-in 120 Ω resistance)																																						



# SECTION 10

## Connecting in Modbus-RTU Mode: Master

10-1	Modbus (RTU Mode, Modicon PLC) . . . . .	106
10-1-1	Connection Method Example . . . . .	107
10-2	Modbus (RTU Mode) . . . . .	108
10-2-1	Connection Method Examples . . . . .	110
10-3	Modbus (RTU Mode   Temperature Controller) . . . . .	111
10-3-1	Connection Method Examples . . . . .	113

## 10-1 Modbus (RTU Mode, Modicon PLC)

### PLC Model Selection

- Modicon PLCs
- Device setting: Start No. xxxxx1  
Select Modbus (RTU Mode | Modicon PLC).

### Applicable Devices

Bit/word devices		No.	Comments
Bit devices	Input relays	100001 to 165536	
	Coils	000001 to 065536	
Word devices	Input relays	100001 to 165536	The address must be a multiple of 16.
	Coils	000001 to 065536	The address must be a multiple of 16.
	Input registers	300001 to 365536	
	Holding registers	400001 to 465536	

**Communications Settings** The following communications settings are recommended for the PT and PLC.

#### ■ PT Communications Settings

Item	Setting
PLC station number	1
Baud rate	19,200 bps
Data length	8
Stop bits	1
Parity	Even

#### ■ PLC Communications Settings

Item	Setting
Slave address	1
Mode	RTU mode
Baud rate	19,200 bps
Data length	8
Stop bits	1
Parity	Even

**Note** Using PLCs from Other Manufacturers  
Always confirm operation on the actual PLC that you intend to use.



### 10-1-1 Connection Method Example

Connection Diagram

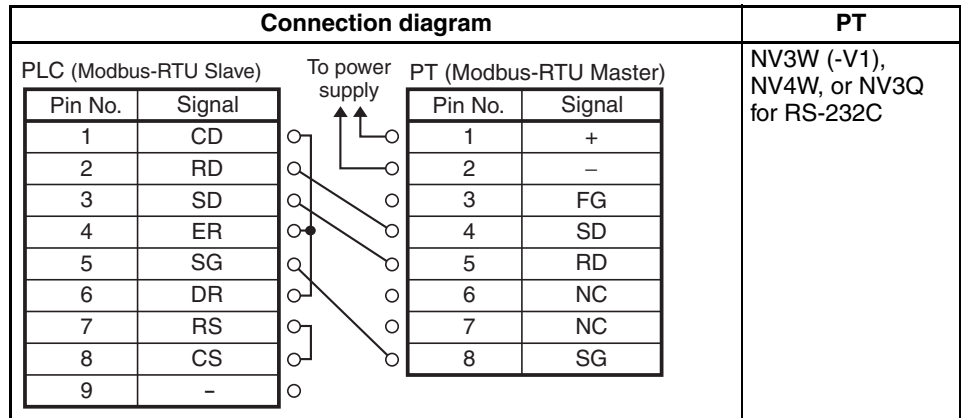

## 10-2 Modbus (RTU Mode)

### Overview of Communications

The PT is the Modbus-RTU master.

The parts on the screens of the PT read and write memory in the PLCs, which are Modbus-RTU slaves.

With the NV3W, communications is possible with only one of the connected PLCs. With the NV3W-V1, NV4W or NV3Q, communications is possible with up to 31 PLCs. (PT system program version 1.1 or higher is required.)

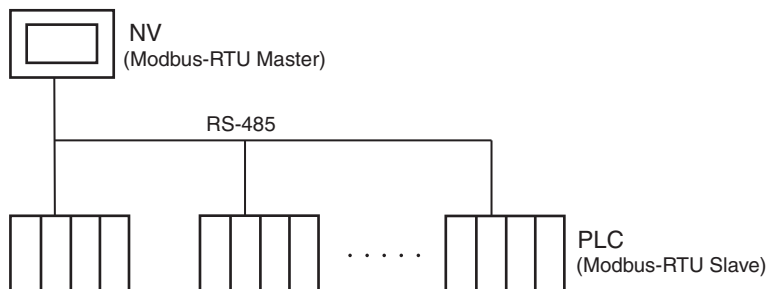

### PLC Model Selection

- Device setting: Start No. xxxxx0  
Select Modbus (RTU Mode).

### Applicable Devices

Bit/word devices		No.	Comments
Bit devices	Input relays	100000 to 165535	
	Coils	000000 to 065535	
Word devices	Input relays	100000 to 165535	The address must be a multiple of 16.
	Coils	000000 to 065535	The address must be a multiple of 16.
	Input registers	300000 to 365535	
	Holding registers	400000 to 465535	

### Communications Settings

The following communications settings are recommended for the PT and PLC.

#### ■ PT Communications Settings

Item	Setting
PLC station number	1
Baud rate	19,200 bps
Data length	8
Stop bits	1
Parity	Even

## ■ PLC Communications Settings

Item	Setting
Slave address	1
Mode	RTU mode
Baud rate	19,200 bps
Data length	8
Stop bits	1
Parity	Even

**Additional Information**

The following function codes can be used for Modbus-RTU communications from the master. Select the function codes for the areas of the addresses that are set.

Function code (hex): Meaning

01: Read coil state

02: Read input bit state

03: Read holding register contents

04: Read input register contents

05: Write coil state for bits

0F: Write coil states for words

10: Write register contents for multiple words

Refer to the Modbus communications specifications and the manuals for the slave devices for details on function codes.

### 10-2-1 Connection Method Examples

#### Connection Diagram

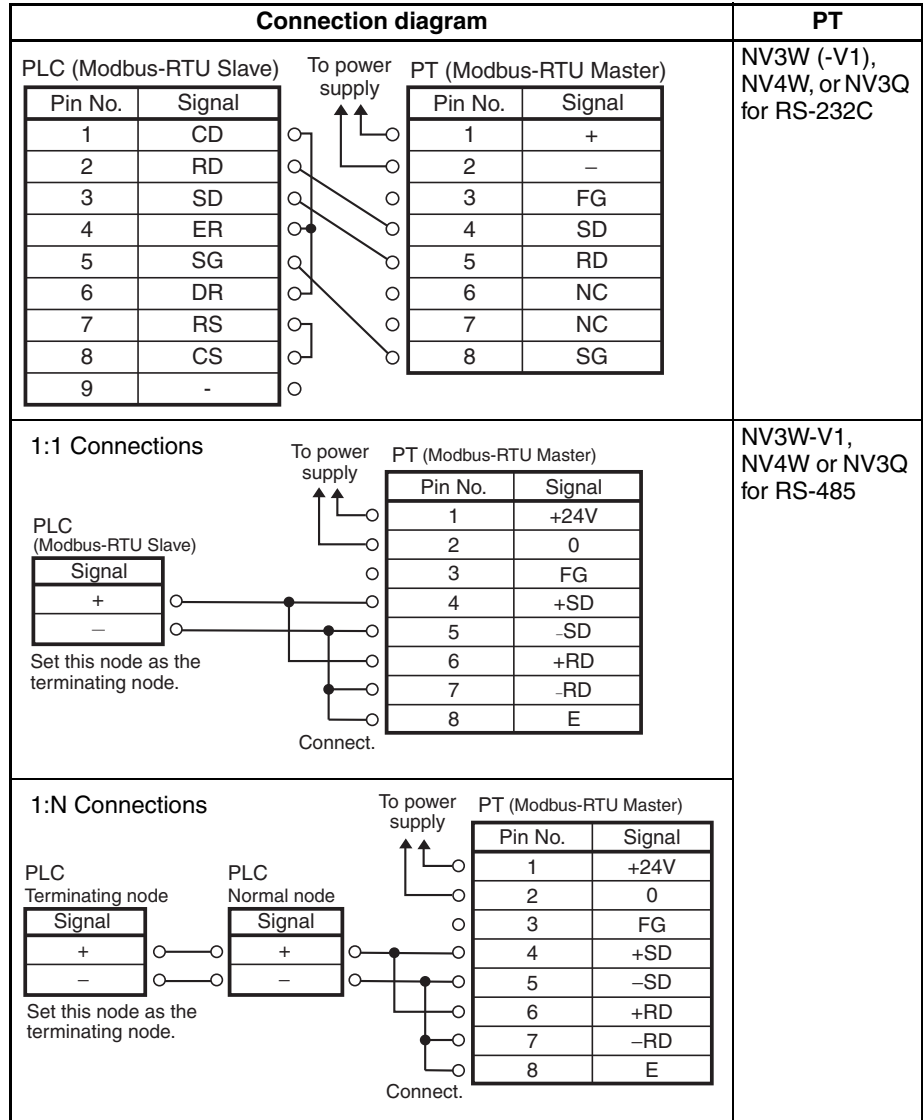

**Note** Using PLCs from Other Manufacturers  
 Always confirm operation on the actual PLC that you intend to use. PLCs for which operation has been verified: DL05 from Koyo Electronics Industries.

# 10-3 Modbus (RTU Mode | Temperature Controller)

## PLC Model Selection

- Select Modbus (RTU Mode | Temperature Controller)

Select this setting when connecting to OMRON EJ1 Temperature Controllers and similar devices.

Modbus (RTU mode | Temperature Controller) can be selected only for the NV3W-V1, NV4W or NV3Q.

Up to 31 Temperature Controllers can be connected.

## Applicable Devices

Bit/word devices	No.	Comments
Bit devices	Treated as holding registers	Area 4 (holding register) + Temperature Controller parameter address (0000 to FFFF) + Bit (.0 to .F) or internal memory address.
Word devices	Treated as holding registers	Area 4 (holding register) + Temperature Controller parameter address (0000 to FFFF) or internal memory address.

### Application Example 1: Allocating the RUN Command for Channel 1 of an EJ1 to a Touch Switch

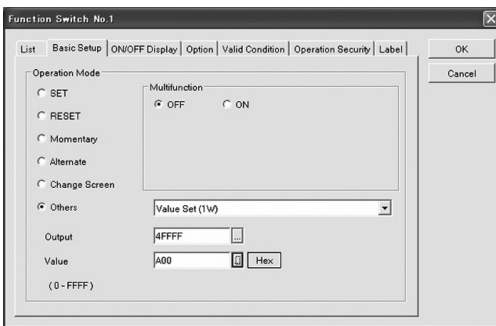

- (1) Paste a function switch (FSW) on the screen.
- (2) Select Value Set (1W) for the Others Option on the Basic Setup Tab Page.
- (3) Click the Output Button. The Address Setting Dialog Box will be displayed. Select 4 for the area, input FFFF for the address, and click the OK Button.
- (4) Click the Dec Button for the Value, change it to the Hex Button, and display the Set Value Dialog Box. Enter 0A00 for the value and click the OK Button.

### Application Example 2: Displaying the PV for Channel 1 of an EJ1 Temperature Controller in EU Units

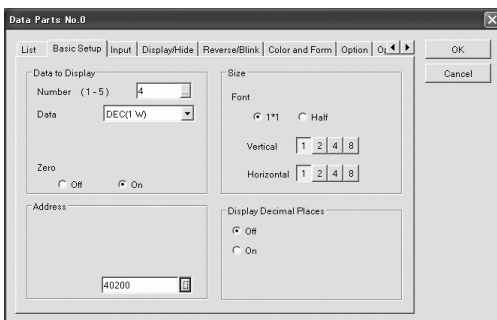

- (1) Paste a data part (Data) on the screen.
- (2) Input 4 for the Number of Digits in the Data to Display Area on the Basic Setup Tab Page and select DEC (1W) for the Data Format.
- (3) Click the Address Button. The Address Setting Dialog Box will be displayed. Select 4 for the area, input 0200 for the address, and click the OK Button.



### Additional Information

- Function codes 03 hex (read holding register) and 06 hex (write holding register, one word) are used for Modbus (RTU Mode | Temperature Controller).
- The default system memory area in the NV-Designer allocates 40000 to 40002 to send to the connected device. When connecting to slaves, such as Temperature Controllers, change this setting to GDT or WGR addresses in internal memory.
- For information on how to input addresses, refer to the *NV-series Programming Manual* (Cat. No. V104).
- For details on addresses for OMRON EJ1 Temperature Controllers, refer to the parameter list and status list in the appendices of the *EJ1 Modular Temperature Controller User's Manual* (Cat. No. H142).

**Communications Settings** The following communications settings are recommended for the PT and Temperature Controller.

■ **PT Communications Settings**

Item	Setting	Comments
PLC station number	1	When specifying connections to more than one PLC, make the settings for each device.
Baud rate	19,200 bps	
Data length	8	
Stop bits	1	Always 1 bit.
Parity	Odd or Even	
Transmission delay	5 ms	For RS-232C communications, 0 ms can also be set. Set the delay according to the device.

**Note** When connecting to OMRON EJ1 Temperature Controllers using Modbus-RTU, set a transmission delay of at least 5 ms in the communications parameters in the NV Configuration of the PT. Communications may not be performed correctly if a transmission delay of 4 ms or less is set. Use a value of the least 5 ms (default) for the port B send wait time in the EJ1. Communications may not be performed correctly if a send wait time of 4 ms or less is set.

■ **Temperature Controller Communications Settings**

Item	Setting	Comments
Slave address	1	
Mode	RTU mode	
Baud rate	19,200 bps	
Data length	8	
Stop bits	1	
Parity	Odd or Even	

**Note** Using PLCs from Other Manufacturers  
Always confirm operation on the actual PLC that you intend to use.  
For the NV Configuration when connected to an EJ1 Temperature Controller, refer to the information on connecting to the EJ1 with Modbus-RTU in the *NV-series Setup Manual* (Cat. No. V103).

### 10-3-1 Connection Method Examples

#### Connection Diagram

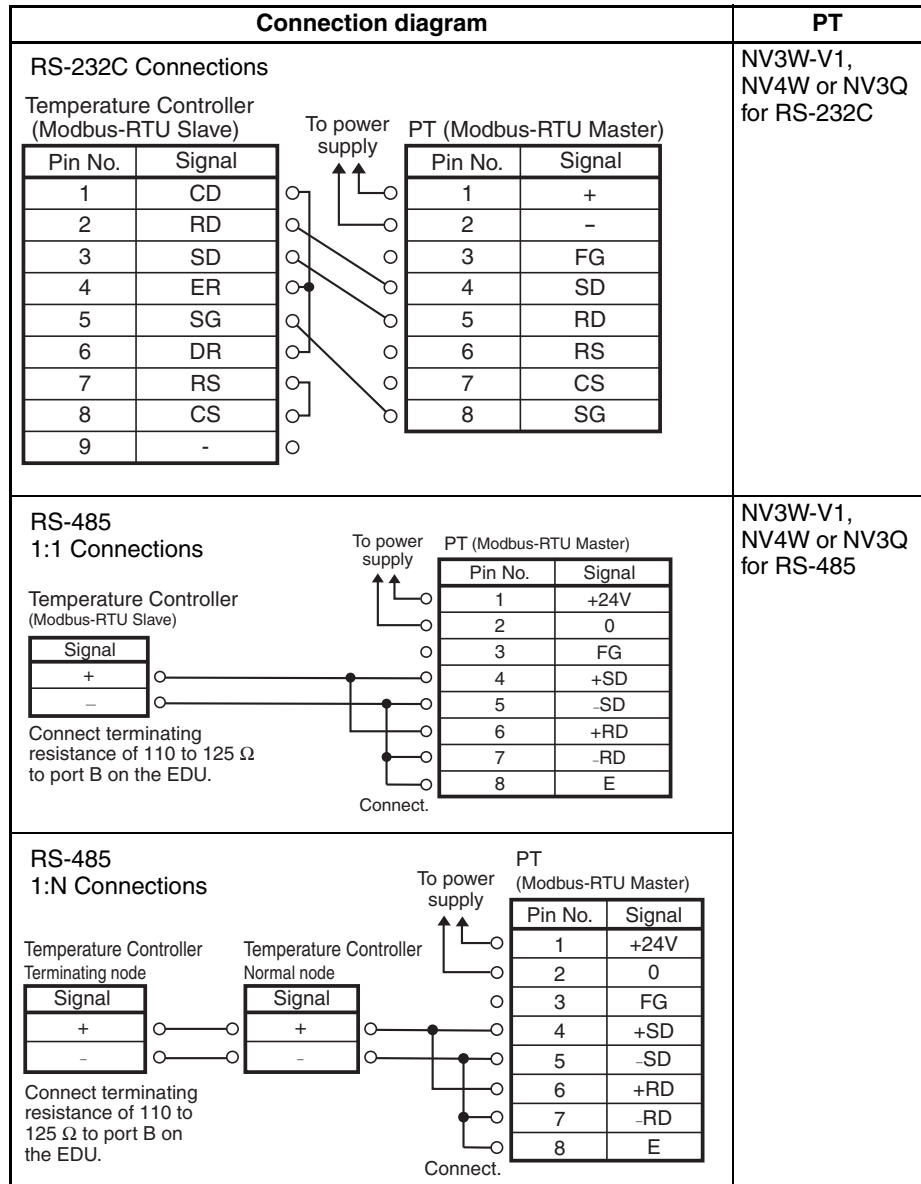

**Note** Use RS-485 connections when connecting to OMRON EJ1 Temperature Controllers. Refer to the information on connecting to EJ1 Temperature Controllers with RS-422A/485 connections in the *NV-series Setup Manual* (Cat. No. V103).





# SECTION 11

## Connecting in Modbus-RTU Mode: Slave

- 11-1 Modbus Slave (RTU Mode) ..... 116
  - 11-1-1 Basic Formats ..... 117
  - 11-1-2 Function Code Reference ..... 119
  - 11-1-3 Connection Method Examples ..... 126

# 11-1 Modbus Slave (RTU Mode)

## Overview of Communications

The PT is the Modbus-RTU slave. Modbus-RTU commands are sent to the PT from the PLC or other Modbus-RTU master to read and to write internal memory in the PT. The parts on the screens of the PT read and write memory in the PT. As a result, the parts on the screens of the PT read and write internal memory in the PLC or other Modbus-RTU master indirectly through the internal memory of the PT. Up to 31 PTs can be connected.

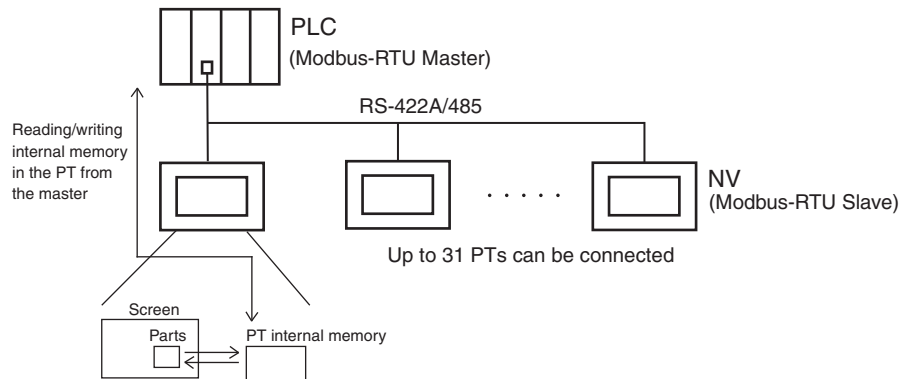

**Note** The timing of reading/writing internal memory in the PT by the PT is not synchronized with the timing of reading/writing internal memory in the PT from the PLC. The data is updated in the master PLC after the communications cycle in the master PLC. Therefore, there can be delays between operations and displays on the PT and reading/writing data in the PLC. Applications that require realtime reading/writing of PT data are not possible.

## PLC Model Selection

- Select Modbus Slave (RTU Mode).

## Applicable Devices

	Bit/word devices		No.	Comments
PT internal memory	Bit devices	Internal bits	GR0 to GR255F	
	Word devices	Internal bits	WGR0 to WGR255	
		Data registers	GDT0 to GDT2047	
		Holding registers	GDT9080 to GDT9086	Internal clock data



### Additional Information

GR or WGR addresses differ only in that they are for bits or words. They access the same internal memory. For example, WGR1 specifies the 16 bits from GR10 to GR1F.

## Communications Settings

The following communications settings are recommended for the PT and PLC.

### ■ PT Communications Settings

Item	Setting
PT slave address	1 to 247
Baud rate	9,600 bps, 19,200 bps, 38,400 bps, 57,600 bps, 115,200 bps
Data length	8
Parity	Odd, even, or none
RS/CS flow control *1	Enabled (for NV3W-V1, NV4W or NV3Q)

\*1 The NV3W does not have RS/CS control lines. Disable RS/CS flow control.

## 11-1-1 Basic Formats

The formats for sending commands from the Modbus-RTU master to the PT and for returning responses from the PT are given below. The maximum length of commands or responses supported by the NV-series PTs is 512 bytes.

### Commands

PT slave address	Function code	Data	Error check
------------------	---------------	------	-------------

### Responses

PT slave address	Function code	Data	Error check
------------------	---------------	------	-------------

#### ■ PT Slave Address

Specify the slave address set in the PT (1 to 247). However, a maximum of 31 PTs can be connected. The Modbus-RTU master can communicate with only one PT at a time. The slave address can be set to 0 for some function codes to specify broadcast mode. If 0 is specified, the command will be received by all slaves regardless of their specified slave numbers. Responses are not returned for broadcast commands.

#### ■ Function Code

The function to be executed by the Modbus-RTU master is specified with the function code. The NV-series PTs support the following function codes.

Function code (hex)	Function	Broadcast mode	Applicable internal memory specifications
01	Read internal bit status		GR/WGR
03	Read holding register contents		GDT
04	Read input register contents		GDT
05	Write single internal bit	Supported.	GR/WGR
06	Write data register, one word	Supported.	GDT
0F	Write multiple internal bits	Supported.	GR
10	Write multiple data registers	Supported.	GDT

#### ■ Data

The data required for the command is sent. The data that is required depends on the function code.

#### ■ Error Check

CRC-16 (cyclic redundancy check) error checking is performed.

**Error Responses**

If there is an error in a data message that is sent, the PT will do nothing except return the following message.

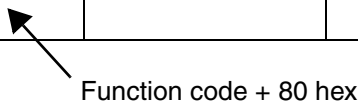
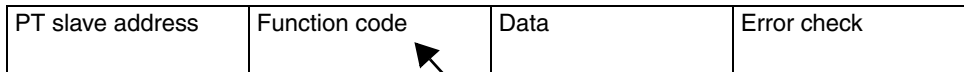

The Modbus-RTU master can check the function code in the response message to see if the data that was sent was correct. If an error occurs, the master can check the error code to confirm the cause of the error.

Code number	Meaning
ER01	There is an error in the function code. (An unsupported function code was sent.)
ER02	There is an error in the address of an internal bit or data register. (The address is out of range.)
ER03	There is an error in the number of internal bits or data registers. (The number of bits or registers is out of range.) The specified number of data items does not match the number that was sent. The data was not 0000 or FF00 hex for function code 05. The specified number of data items to read caused the response to exceed 512 bytes.

**No Responses**

In the following cases, the PT will ignore the command and will not return a response. If the slave address is 0 for write function codes, no response will be returned.

1. If a transmission error is detected in the command. (Transmission errors include overrun, framing, parity, and CRC-16 errors.)
2. If the slave address of the PT does not match the address specified in the command.
3. If the time between data elements in the command is too long. (If the time between data elements is more than the time required for 24 bits.)

### 11-1-2 Function Code Reference

Provide an interval of at least the time required for four characters between messages with Modbus slave (RTU Mode).

#### Function Code 01: Read internal bit status

##### ■ Commands

PT slave address	Function code 01 hex	First address, upper byte	First address, lower byte	No. of bits to read, upper byte	No. of bits to read, lower byte	Error check, upper byte	Error check, lower byte
1 byte	1 byte	1 byte	1 byte	1 byte	1 byte	1 byte	1 byte

##### ■ Responses

PT slave address	Function code 01 hex	Number of bytes	Data byte 1	.....	Data byte n	Error check, upper byte	Error check, lower byte
1 byte	1 byte	1 byte	1 byte		1 byte	1 byte	1 byte

Item	Function
PT slave address	Specify the slave address of the PT to which to send the message. For slave address 20, specify 14 hex.
Function code	Specify 01 hex.
First address	Specify the address of the first bit to read in hexadecimal. For GR20, specify 00 hex, 20 hex.
No. of bits to read	Specify the number of bits to read in hexadecimal. For 37 bits, specify 00 hex, 25 hex. Up to 2,040 bits can be specified. (Specify 07 hex, F8 hex.)
Number of data bytes	The number of bytes from data byte 1 to data byte n is returned.
Byte 1 to n	The ON/OFF status of the coils starting from the first coil are returned in units of 8 bits. LSB of byte 1 is the status of the first bit. Status is returned in units of 8 bits. Bits in byte n that do not correspond to specified bits will be returned as 0.
Error check	The CRC-16 values are sent and received.

**Function Code 03: Read holding register contents**

■ **Commands**

PT slave address	Function code 03 hex	First address, upper byte	First address, lower byte	No. of registers to read, upper byte	No. of registers to read, lower byte	Error check, upper byte	Error check, lower byte
1 byte	1 byte	1 byte	1 byte	1 byte	1 byte	1 byte	1 byte

■ **Responses**

PT slave address	Function code 03 hex	Number of bytes	Register 1, upper byte	Register 1, lower byte	.....	Register n, upper byte	Register n, lower byte
1 byte	1 byte	1 byte	1 byte	1 byte		1 byte	1 byte

Error check, upper byte	Error check, lower byte
1 byte	1 byte

Item	Function
PT slave address	Specify the slave address of the PT to which to send the message. For slave address 20, specify 14 hex.
Function code	Specify 03 hex.
First address	Specify the address of the first data register to read in hexadecimal. For GDT108, specify 00 hex, 6C hex.
No. of registers to read	Specify the number of data registers to read in hexadecimal. For 5 registers, specify 00 hex, 05 hex. Up to 127 registers can be specified. (Specify 00 hex, 7F hex.)
Number of bytes	The number of bytes from register 1 to register n is returned.
Register 1 to n	The contents of the first data register is returned with the upper byte first, followed by the lower byte. The contents of the specified number of registers are returned.
Error check	The CRC-16 values are sent and received.

**Function Code 04: Read holding register contents**

■ **Commands**

PT slave address	Function code 04 hex	First address, upper byte	First address, lower byte	No. of registers to read, upper byte	No. of registers to read, lower byte	Error check, upper byte	Error check, lower byte
1 byte	1 byte	1 byte	1 byte	1 byte	1 byte	1 byte	1 byte

■ **Responses**

PT slave address	Function code 04 hex	Number of bytes	Register 1, upper byte	Register 1, lower byte	.....	Register n, upper byte	Register n, lower byte
1 byte	1 byte	1 byte	1 byte	1 byte		1 byte	1 byte

Error check, upper byte	Error check, lower byte
1 byte	1 byte

Item	Function
PT slave address	Specify the slave address of the PT to which to send the message. For slave address 20, specify 14 hex.
Function code	Specify 04 hex.
First address	Specify the address of the first data register to read in hexadecimal. For GDT108, specify 00 hex, 6C hex.
No. of registers to read	Specify the number of data registers to read in hexadecimal. For 5 registers, specify 00 hex, 05 hex. Up to 127 registers can be specified. (Specify 00 hex, 7F hex.)
Number of bytes	The number of bytes from register 1 to register n is returned.
Register 1 to n	The contents of the first data register is returned with the upper byte first, followed by the lower byte. The contents of the specified number of registers are returned.
Error check	The CRC-16 values are sent and received.



**Additional Information**

Different function codes are used to read holding registers and input registers with Modbus communications. When reading internal memory in the PT, either function code can be used. The same area will be read.

**Function Code 05: Write single internal bit****■ Commands**

PT slave address	Function code 05 hex	Bit address, upper byte	Bit address, lower byte	Status specification, upper byte	Status specification, lower byte	Error check, upper byte	Error check, lower byte
1 byte	1 byte	1 byte	1 byte	1 byte	1 byte	1 byte	1 byte

**■ Responses**

PT slave address	Function code 05 hex	Bit address, upper byte	Bit address, lower byte	Status specification, upper byte	Status specification, lower byte	Error check, upper byte	Error check, lower byte
1 byte	1 byte	1 byte	1 byte	1 byte	1 byte	1 byte	1 byte

Item	Function
PT slave address	Specify the slave address of the PT to which to send the message. For slave address 20, specify 14 hex.
Function code	Specify 05 hex.
Bit address	Specify the Internal bit address to write in hexadecimal. For GR173, specify 01 hex, 13 hex.
Status specification	To specify ON, use FF hex (upper byte), 00 hex (lower byte) To specify OFF, use 00 hex, 00 hex
Error check	The CRC-16 values are sent and received.

The response will contain the same message as the command.

**Additional Information**

To convert a GR address in internal memory to a bit address, use the rightmost digit of the GR address as the rightmost digit of the bit address and convert the remaining digits from decimal to hexadecimal.

Example:  
 GRA to 000A  
 GR1E to 001E  
 GR153 to 00F3  
 GR163 to 0103  
 GR225F to 0FFF



**Function Code 06: Write data register, one word**

**■ Commands**

PT slave address	Function code 06 hex	Data register address, upper byte	Data register address, lower byte	Write data, upper byte	Write data, lower byte	Error check, upper byte	Error check, lower byte
1 byte	1 byte	1 byte	1 byte	1 byte	1 byte	1 byte	1 byte

**■ Responses**

PT slave address	Function code 06 hex	Data register address, upper byte	Data register address, lower byte	Write data, upper byte	Write data, lower byte	Error check, upper byte	Error check, lower byte
1 byte	1 byte	1 byte	1 byte	1 byte	1 byte	1 byte	1 byte

Item	Function
PT slave address	Specify the slave address of the PT to which to send the message. For slave address 20, specify 14 hex.
Function code	Specify 06 hex.
Data register address	Specify the data register address to write in hexadecimal. For GDT510, specify 01 hex, FE hex.
Write data	Send the value to write with the upper byte first, followed by the lower byte. To write 1234 hex, specify 12 hex, 34 hex.
Error check	The CRC-16 values are sent and received.

The response will contain the same message as the command.

**Function Code 0F: Write multiple internal bits**

■ **Commands**

PT slave address	Function code 0F hex	First address, upper byte	First address, lower byte	Number of bits to write, upper byte	Number of bits to write, lower byte	Number of bytes	Data byte 1
1 byte	1 byte	1 byte	1 byte	1 byte	1 byte	1 byte	1 byte
.....	Data byte n	Error check, upper byte	Error check, lower byte				
	1 byte	1 byte	1 byte				

■ **Responses**

PT slave address	Function code 0F hex	First address, upper byte	First address, lower byte	Number of bits to write, upper byte	Number of bits to write, lower byte	Error check, upper byte	Error check, lower byte
1 byte	1 byte	1 byte	1 byte	1 byte	1 byte	1 byte	1 byte

Item	Function
PT slave address	Specify the slave address of the PT to which to send the message. For slave address 20, specify 14 hex.
Function code	Specify 0F hex.
First address	Specify the internal bit address to write in hexadecimal. For GR12F, specify 00 hex, CF hex.
Number of bits to write	Send the number of the internal bits to write with the upper bytes first, followed by the lower bytes. To write 20 bits, specify 00 hex, 14 hex.
Number of bytes	Specify the number of bytes from data byte 1 to data byte n.
Data bytes 1 to n	Send the ON/OFF status of the internal bits starting from the first bit in units of 8 bits. LSB of byte 1 is the status of the first internal bit. Status is sent in units of 8 bits. Set bits in byte n that do not correspond to specified bits to 0.
Error check	The CRC-16 values are sent and received.

The response will be the command message with the data from the number of bytes to byte n removed.

**Function Code 10: Write multiple data registers**

■ **Commands**

PT slave address	Function code 10 hex	First address, upper byte	First address, lower byte	Number of registers to write, upper byte	Number of registers to write, lower byte	Number of bytes	Register 1, upper byte
1 byte	1 byte	1 byte	1 byte	1 byte	1 byte	1 byte	1 byte
Register 1, lower byte	.....	Register n, upper byte	Register n, lower byte	Error check, upper byte	Error check, lower byte		
1 byte		1 byte	1 byte	1 byte	1 byte		

■ **Responses**

PT slave address	Function code 10 hex	First address, upper byte	First address, lower byte	Number of registers to write, upper byte	Number of registers to write, lower byte	Error check, upper byte	Error check, lower byte
1 byte	1 byte	1 byte	1 byte	1 byte	1 byte	1 byte	1 byte

Item	Function
PT slave address	Specify the slave address of the PT to which to send the message. For slave address 20, specify 14 hex.
Function code	Specify 10 hex.
First address	Specify the address of the first register to write in hexadecimal. For GDT1230, specify 04 hex, CE hex.
Number of registers to write	Send the number of data registers to write with the upper bytes first, followed by the lower bytes. To write 20 registers, specify 00 hex, 14 hex.
Number of bytes	Specify the number of bytes from register 1 to register n.
Register 1 to n	Send the data to write starting from the first data register with the upper bytes first, followed by the lower bytes.
Error check	The CRC-16 values are sent and received.

The response will be the command message with the data from the number of bytes to register n removed.

### 11-1-3 Connection Method Examples

#### Connection Diagram

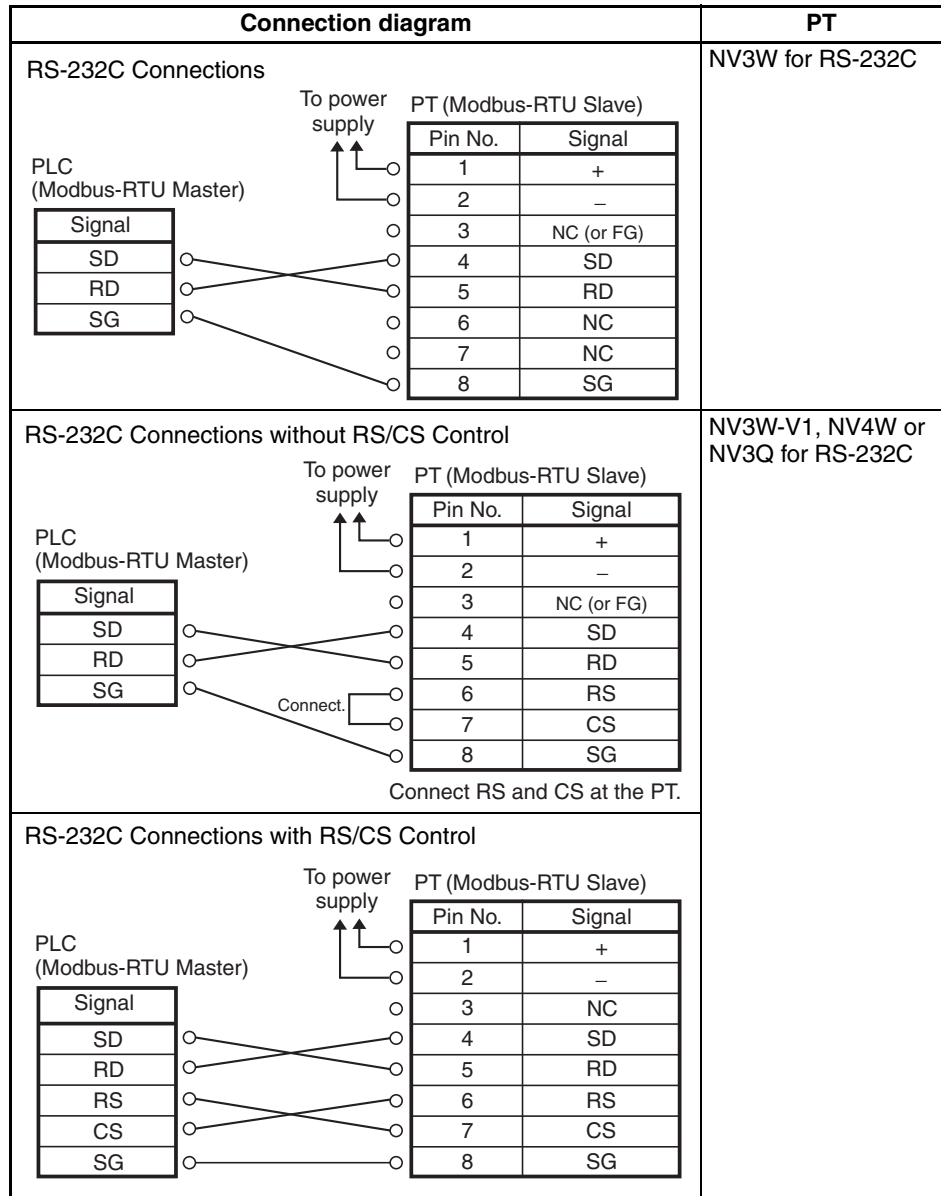

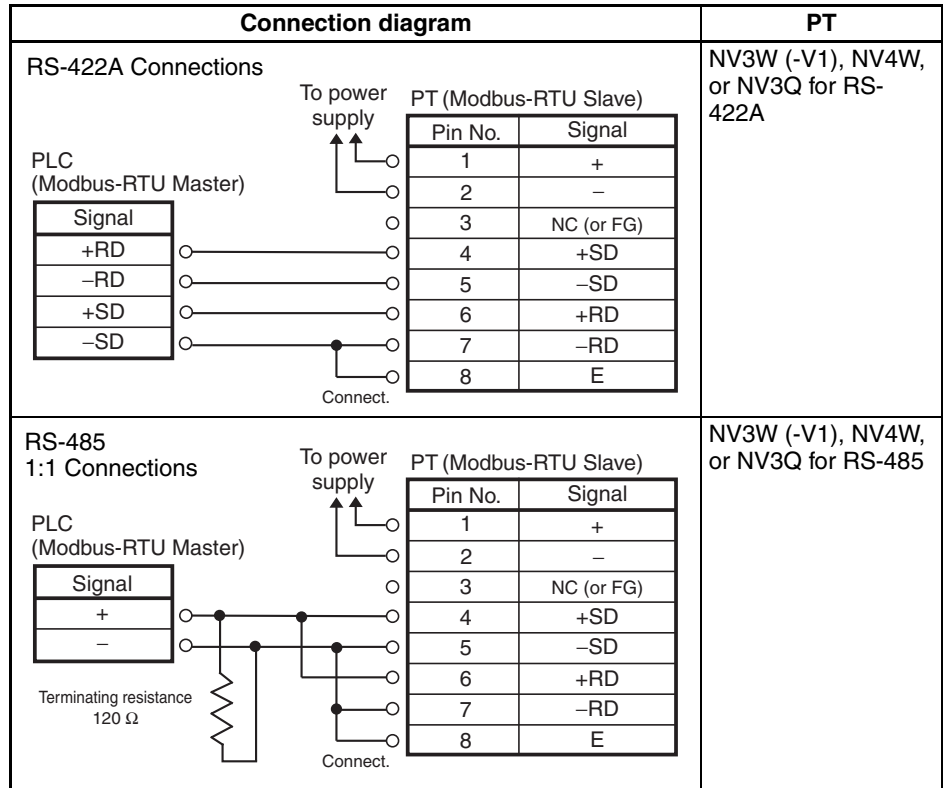

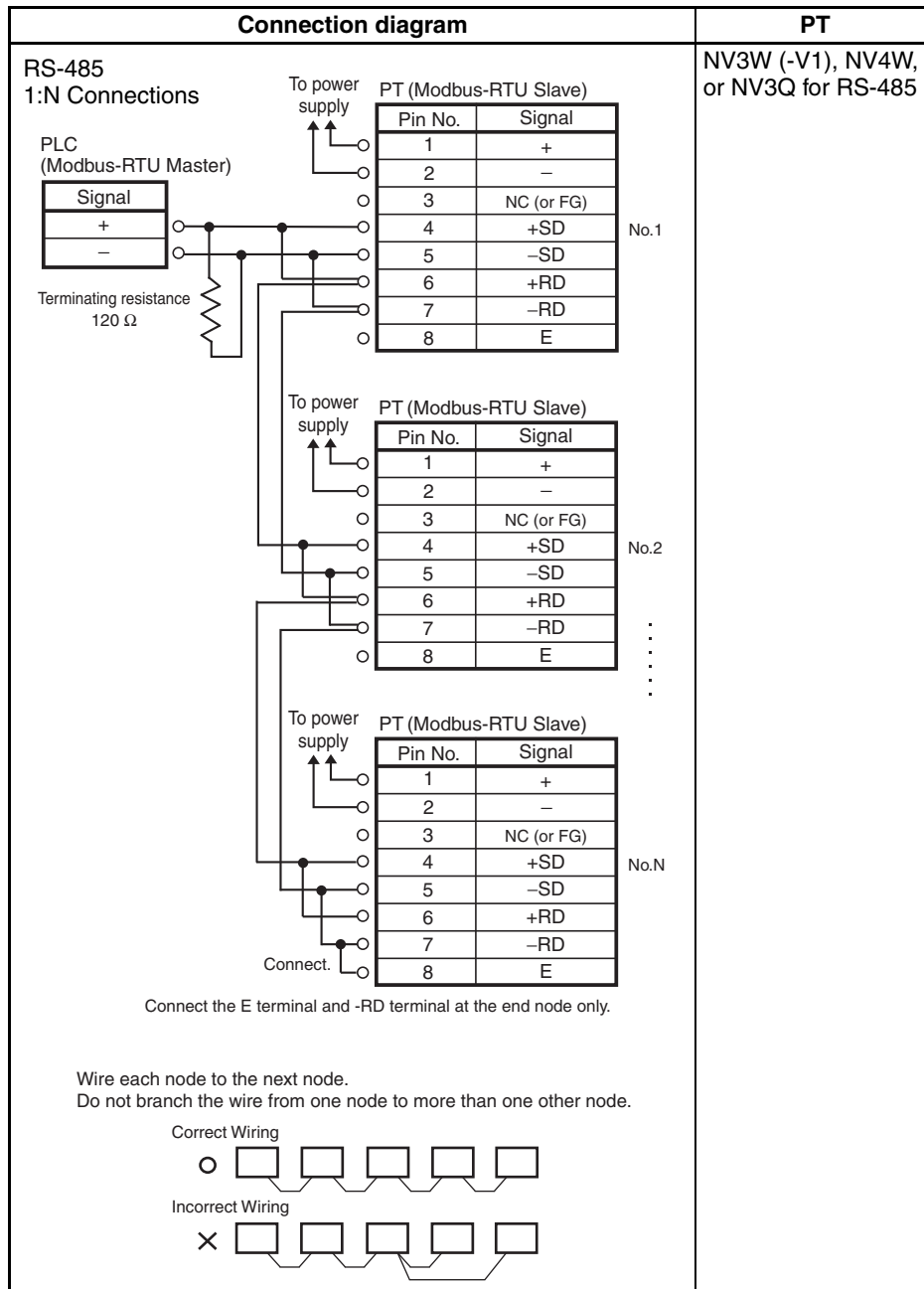

**Note** If there is a lot of noise in the environment, implement noise countermeasures, such as using shielded cables and attaching ferrite cores. Make sure that the shield is not exposed, which would make it vulnerable to static electricity.

The number of nodes, transmission distance, and baud rate will depend on the devices on the network. Confirm operation using the actual devices.

The maximum transmission distance for 24-V RS-232C for NV-series PTs is 15 m.

The maximum transmission distance for 5-V RS-232C for NV3W (-V1) PTs is 30 m.

The maximum transmission distance for 24-V RS-422A for NV-series PTs is 500 m.

Connection for RS-485 may not be possible depending of the switchover timing between sending and receiving at the remote device. Confirm operation using the actual devices.

## SECTION 12

# Error Codes for Companies Other Than OMRON

12-1	Error Codes .....	112
12-2	Mitsubishi Electric FX-series PLC Connections .....	113
12-2-1	NV3W.....	113
12-2-2	NV3W-V1/NV4W/NV3Q .....	113
12-3	Panasonic Electric Works FP-series PLC Connections.....	114
12-3-1	NV3W.....	114
12-3-2	NV3W-V1/NV4W/NV3Q .....	114
12-4	Toshiba Machine PLC Connections .....	116
12-4-1	NV3W-V1/NV4W/NV3Q .....	116
12-5	Modbus Connections.....	117
12-5-1	NV3W.....	117
12-5-2	NV3W-V1/NV4W/NV3Q .....	117
12-5-3	Modbus Connections to OMRON EJ1 Temperature Controller....	117

## 12-1 Error Codes

If an error occurs in an NV-series PT, an error code will be displayed in the upper right corner of the screen. There are two types of error codes: PT error codes and PLC error codes.

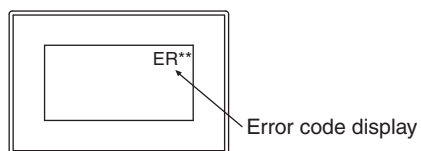

Refer to the *NV-series PT Setup Manual* (Cat. No. V103) for PT error codes and for error codes that may be displayed when connected to an OMRON PLC.



## 12-2 Mitsubishi Electric FX-series PLC Connections

### 12-2-1 NV3W

Error code	Description	Cause and countermeasure
ERFF	Timeout Error The PLC did not return a response.	1. The cable connecting the PLC is disconnected. Check the cable for incorrect wiring or disconnections. 2. A temporary error was caused by noise or other factor. Cycle the power to the PLC or PT.
ER10	Data Error An error occurred in the data during communications.	Make sure that the communications settings are correct.
ER12	Overrun Error The PT cannot receive data.	The PLC may be running out of control.
ER61	PLC Error The PLC returned a NAK error.	Check the PLC settings.

### 12-2-2 NV3W-V1/NV4W/NV3Q

Error code	Description	Cause and countermeasure
ERFFFE	PLC Error The PLC returned a NAK error.	Check the PLC settings.

## 12-3 Panasonic Electric Works FP-series PLC Connections

### 12-3-1 NV3W

Error code	Description	Cause and countermeasure
ER21	Data Error An error occurred in the data during communications.	1. There is a mistake in the communications settings. Make sure that the baud rates and transmission formats are correct for the PLC and PT. 2. A temporary error was caused by noise or other factor. Cycle the power to the PLC and PT.
ER22	Overrun Error The PT cannot receive data.	The reception buffer in the CPU Unit overflowed. An error may have occurred in the PLC. Cycle the power to the PLC and PT.
ER40	BCC Error An error occurred in the data during communications.	1. A temporary error was caused by noise or other factor. Cycle the power to the PLC and PT. 2. An error may have occurred in the CPU Unit. Cycle the power to the PLC and PT.
ER41	Format Error A command that is not valid for the protocol was sent to the PLC.	1. A temporary error was caused by noise or other factor. Cycle the power to the PLC and PT. 2. An error may have occurred in the CPU Unit. Cycle the power to the PLC and PT.
ER42	Not Supported Error A command that is not supported by the PT was sent to the PLC.	1. A temporary error was caused by noise or other factor. Cycle the power to the PLC and PT. 2. An error may have occurred in the CPU Unit. Cycle the power to the PLC and PT.
ER53	Busy Error The PLC is processing another command.	The PLC is transferring a large quantity of data on another RS-232C port. Wait until the error clears.
ER60	Parameter Error	The value set for the parameter does not exist or cannot be used.
ER61	Data Error There was a mistake in a register or relay address.	A register or relay that does not exist in the PLC was specified when creating screens on the NV-Designer. Correct the addresses used by parts, to output the clock data, etc.

### 12-3-2 NV3W-V1/NV4W/NV3Q

Error code	Description	Cause and countermeasure
ER0021	Data Error An error occurred in the data during communications.	1. There is a mistake in the communications settings. Make sure that the baud rates and transmission formats are correct for the PLC and PT. 2. A temporary error was caused by noise or other factor. Cycle the power to the PLC and PT.
ER0022	Overrun Error The PT cannot receive data.	The reception buffer in the CPU Unit overflowed. An error may have occurred in the PLC. Cycle the power to the PLC and PT.
ER0040	BCC Error An error occurred in the data during communications.	1. A temporary error was caused by noise or other factor. Cycle the power to the PLC and PT. 2. An error may have occurred in the CPU Unit. Cycle the power to the PLC and PT.
ER0041	Format Error A command that is not valid for the protocol was sent to the PLC.	1. A temporary error was caused by noise or other factor. Cycle the power to the PLC and PT. 2. An error may have occurred in the CPU Unit. Cycle the power to the PLC and PT.
ER0042	Not Supported Error A command that is not supported by the PT was sent to the PLC.	1. A temporary error was caused by noise or other factor. Cycle the power to the PLC and PT. 2. An error may have occurred in the CPU Unit. Cycle the power to the PLC and PT.
ER0053	Busy Error The PLC is processing another command.	The PLC is transferring a large quantity of data on another RS-232C port. Wait until the error clears.

<b>Error code</b>	<b>Description</b>	<b>Cause and countermeasure</b>
ER0060	Parameter Error	The value set for the parameter does not exist or cannot be used.
ER0061	Data Error There was a mistake in a register or relay address.	A register or relay that does not exist in the PLC was specified when creating screens on the NV-Designer. Correct the addresses used by parts, to output the clock data, etc.

## 12-4 Toshiba Machine PLC Connections

### 12-4-1 NV3W-V1/NV4W/NV3Q

Error code	Description	Cause and countermeasure
ERFFFE	Parameter Error	The value set for the parameter does not exist or cannot be used.

## 12-5 Modbus Connections

### 12-5-1 NV3W

Error code	Description	Cause and countermeasure
ERFF	Timeout Error The PLC did not return a response.	<ol style="list-style-type: none"> <li>1. The cable connecting the PLC is disconnected. Check the cable for incorrect wiring or disconnections.</li> <li>2. A temporary error was caused by noise or other factor. Cycle the power to the PLC or PT.</li> </ol>
ERFE	Response Error An error response was returned by the external device.	Check the data that was returned by the external device.

### 12-5-2 NV3W-V1/NV4W/NV3Q

Error code	Description	Cause and countermeasure
ER0001	Timeout Error The PLC did not return a response.	<ol style="list-style-type: none"> <li>1. The cable connecting the PLC is disconnected. Check the cable for incorrect wiring or disconnections.</li> <li>2. A temporary error was caused by noise or other factor. Cycle the power to the PLC or PT.</li> </ol>
ERFFFE	Response Error An error response was returned by the external device.	Check the data that was returned by the external device.

### 12-5-3 Modbus Connections to OMRON EJ1 Temperature Controller

NV3W error codes are displayed as "ER" followed by the two-digit code. NV3-V1/NV4W/NV3Q error codes are displayed as "ER00" followed by the two digit error code.

The notation for the NV3W is used in the following table. When using the NV4W or NV3Q, "00" will be displayed after "ER."

Error code	Description	Cause and countermeasure
ER01	Function code error	The function code is not supported.
ER02	Variable address error	<ol style="list-style-type: none"> <li>1. There is an error in the write start address.</li> <li>2. There is an error in the read start address.</li> </ol>
ER03	Variable data error	<ol style="list-style-type: none"> <li>1. The command is too short.</li> <li>2. The command is too long.</li> <li>3. The number of elements exceeds the maximum value.</li> <li>4. The number of elements and data do not match.</li> <li>5. The number of elements times two does not match the byte count.</li> <li>6. The write data is outside the setting range.</li> <li>7. An attempt was made to write to a read-only variable.</li> </ol>
ER04	Operation error	<ol style="list-style-type: none"> <li>1. The operation command could not be received and was not executed.</li> <li>2. The operation was not executed because data was being backed up.</li> <li>3. The operation was not executed because a reset was being processed (including when starting).</li> <li>4. The operation was not executed because the Controller was in Tuning Mode.</li> </ol>



## Revision History

A manual revision code appears as a suffix to the catalog number on the front cover of the manual.

Cat. No. V105-E1-03

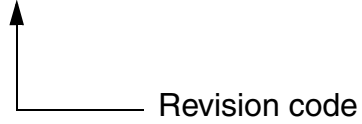

The following table outlines the changes made to the manual during each revision. Page numbers refer to the previous version.

Revision code	Date	Revised content
01	June 2009	Original production
02	December 2009	Mode revisions accompanying version upgrade and the addition of the NV4W.
03	May 2015	Made revisions accompanying version upgrade and the addition of the NV3W-V1

---

*Revision History*

---





**OMRON Corporation** Industrial Automation Company  
Tokyo, JAPAN

Contact: [www.ia.omron.com](http://www.ia.omron.com)

**Regional Headquarters**

**OMRON EUROPE B.V.**

Wegalaan 67-69, 2132 JD Hoofddorp  
The Netherlands  
Tel: (31)2356-81-300/Fax: (31)2356-81-388

**OMRON ELECTRONICS LLC**

2895 Greenspoint Parkway, Suite 200  
Hoffman Estates, IL 60169 U.S.A  
Tel: (1) 847-843-7900/Fax: (1) 847-843-7787

**OMRON ASIA PACIFIC PTE. LTD.**

No. 438A Alexandra Road # 05-05/08 (Lobby 2),  
Alexandra Technopark,  
Singapore 119967  
Tel: (65) 6835-3011/Fax: (65) 6835-2711

**OMRON (CHINA) CO., LTD.**

Room 2211, Bank of China Tower,  
200 Yin Cheng Zhong Road,  
PuDong New Area, Shanghai, 200120, China  
Tel: (86) 21-5037-2222/Fax: (86) 21-5037-2200

**Authorized Distributor:**

© OMRON Corporation 2009 All Rights Reserved.  
In the interest of product improvement,  
specifications are subject to change without notice.

**Cat. No. V105-E1-03**

0515