

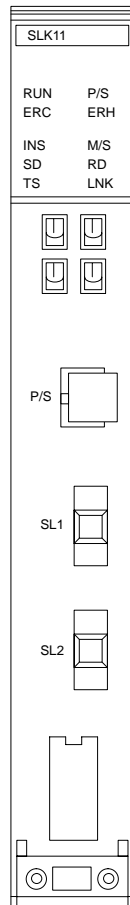

SYSMAC CV-series SYSMAC LINK System

System Manual

Revised July 1998



Read and Understand this Manual

Please read and understand this manual before using the product. Please consult your OMRON representative if you have any questions or comments.

Warranty and Limitations of Liability

WARRANTY

OMRON's exclusive warranty is that the products are free from defects in materials and workmanship for a period of one year (or other period if specified) from date of sale by OMRON.

OMRON MAKES NO WARRANTY OR REPRESENTATION, EXPRESS OR IMPLIED, REGARDING NON-INFRINGEMENT, MERCHANTABILITY, OR FITNESS FOR PARTICULAR PURPOSE OF THE PRODUCTS. ANY BUYER OR USER ACKNOWLEDGES THAT THE BUYER OR USER ALONE HAS DETERMINED THAT THE PRODUCTS WILL SUITABLY MEET THE REQUIREMENTS OF THEIR INTENDED USE. OMRON DISCLAIMS ALL OTHER WARRANTIES, EXPRESS OR IMPLIED.

LIMITATIONS OF LIABILITY

OMRON SHALL NOT BE RESPONSIBLE FOR SPECIAL, INDIRECT, OR CONSEQUENTIAL DAMAGES, LOSS OF PROFITS OR COMMERCIAL LOSS IN ANY WAY CONNECTED WITH THE PRODUCTS, WHETHER SUCH CLAIM IS BASED ON CONTRACT, WARRANTY, NEGLIGENCE, OR STRICT LIABILITY.

In no event shall the responsibility of OMRON for any act exceed the individual price of the product on which liability is asserted.

IN NO EVENT SHALL OMRON BE RESPONSIBLE FOR WARRANTY, REPAIR, OR OTHER CLAIMS REGARDING THE PRODUCTS UNLESS OMRON'S ANALYSIS CONFIRMS THAT THE PRODUCTS WERE PROPERLY HANDLED, STORED, INSTALLED, AND MAINTAINED AND NOT SUBJECT TO CONTAMINATION, ABUSE, MISUSE, OR INAPPROPRIATE MODIFICATION OR REPAIR.

Application Considerations

SUITABILITY FOR USE

OMRON shall not be responsible for conformity with any standards, codes, or regulations that apply to the combination of products in the customer's application or use of the products.

At the customer's request, OMRON will provide applicable third party certification documents identifying ratings and limitations of use that apply to the products. This information by itself is not sufficient for a complete determination of the suitability of the products in combination with the end product, machine, system, or other application or use.

The following are some examples of applications for which particular attention must be given. This is not intended to be an exhaustive list of all possible uses of the products, nor is it intended to imply that the uses listed may be suitable for the products:

- Outdoor use, uses involving potential chemical contamination or electrical interference, or conditions or uses not described in this manual.
- Nuclear energy control systems, combustion systems, railroad systems, aviation systems, medical equipment, amusement machines, vehicles, safety equipment, and installations subject to separate industry or government regulations.
- Systems, machines, and equipment that could present a risk to life or property.

Please know and observe all prohibitions of use applicable to the products.

NEVER USE THE PRODUCTS FOR AN APPLICATION INVOLVING SERIOUS RISK TO LIFE OR PROPERTY WITHOUT ENSURING THAT THE SYSTEM AS A WHOLE HAS BEEN DESIGNED TO ADDRESS THE RISKS, AND THAT THE OMRON PRODUCTS ARE PROPERLY RATED AND INSTALLED FOR THE INTENDED USE WITHIN THE OVERALL EQUIPMENT OR SYSTEM.

PROGRAMMABLE PRODUCTS

OMRON shall not be responsible for the user's programming of a programmable product, or any consequence thereof.

Disclaimers

CHANGE IN SPECIFICATIONS

Product specifications and accessories may be changed at any time based on improvements and other reasons.

It is our practice to change model numbers when published ratings or features are changed, or when significant construction changes are made. However, some specifications of the products may be changed without any notice. When in doubt, special model numbers may be assigned to fix or establish key specifications for your application on your request. Please consult with your OMRON representative at any time to confirm actual specifications of purchased products.

DIMENSIONS AND WEIGHTS

Dimensions and weights are nominal and are not to be used for manufacturing purposes, even when tolerances are shown.

PERFORMANCE DATA

Performance data given in this manual is provided as a guide for the user in determining suitability and does not constitute a warranty. It may represent the result of OMRON's test conditions, and the users must correlate it to actual application requirements. Actual performance is subject to the OMRON Warranty and Limitations of Liability.

ERRORS AND OMISSIONS

The information in this manual has been carefully checked and is believed to be accurate; however, no responsibility is assumed for clerical, typographical, or proofreading errors, or omissions.

Notice:

OMRON products are manufactured for use according to proper procedures by a qualified operator and only for the purposes described in this manual.

The following conventions are used to indicate and classify precautions in this manual. Always heed the information provided with them. Failure to heed precautions can result in injury to people or damage to property.

 **DANGER** Indicates an imminently hazardous situation which, if not avoided, will result in death or serious injury.

 **WARNING** Indicates a potentially hazardous situation which, if not avoided, could result in death or serious injury.

 **Caution** Indicates a potentially hazardous situation which, if not avoided, may result in minor or moderate injury, or property damage.

OMRON Product References

All OMRON products are capitalized in this manual. The word “Unit” is also capitalized when it refers to an OMRON product, regardless of whether or not it appears in the proper name of the product.

The abbreviation “Ch,” which appears in some displays and on some OMRON products, often means “word” and is abbreviated “Wd” in documentation in this sense.

The abbreviation “PC” means Programmable Controller and is not used as an abbreviation for anything else.

Visual Aids

The following headings appear in the left column of the manual to help you locate different types of information.

Note Indicates information of particular interest for efficient and convenient operation of the product.

1, 2, 3... 1. Indicates lists of one sort or another, such as procedures, checklists, etc.

© OMRON, 1992

All rights reserved. No part of this publication may be reproduced, stored in a retrieval system, or transmitted, in any form, or by any means, mechanical, electronic, photocopying, recording, or otherwise, without the prior written permission of OMRON.

No patent liability is assumed with respect to the use of the information contained herein. Moreover, because OMRON is constantly striving to improve its high-quality products, the information contained in this manual is subject to change without notice. Every precaution has been taken in the preparation of this manual. Nevertheless, OMRON assumes no responsibility for errors or omissions. Neither is any liability assumed for damages resulting from the use of the information contained in this publication.

TABLE OF CONTENTS

PRECAUTIONS	
1 Intended Audience	
2 General Precautions	
3 Safety Precautions	
4 Operating Environment Precautions	
5 Application Precautions	
SECTION 1	
Introduction	
1-1 OMRON Network Systems	
1-2 SYSMAC LINK System Features	
1-3 System Configuration	
SECTION 2	
Unit Components and Switch Settings	
2-1 Nomenclature	
2-2 Indicators and Switch Settings	
2-3 Mounting Units	
2-4 Unit Dimensions	
SECTION 3	
Installation	
3-1 Cable Connection	
3-2 Power Supply Unit Connection	
SECTION 4	
Basic Communications	
4-1 SYSMAC LINK System Communications	
4-2 Unit Number	
4-3 Setting Node Addresses	
4-4 Network Address Setting	
4-5 Network Parameters	
4-6 Memory Areas	
SECTION 5	
Data Links	
5-1 Introduction	
5-2 Creating Data Links	
5-3 Automatic Generation of Data Link Tables	
5-4 Manually Generating Data Link Tables	
5-5 Data Link Table Examples	
5-6 Controlling Data Links	
5-7 Data Link Precautions	
5-8 Data Link Status	
5-9 Data Link Characteristics	
SECTION 6	
Network Data Exchange	
6-1 Data Exchange between Networks	
6-2 Routing Tables	
6-3 Relay Network Tables	
6-4 Routing Table Examples	

TABLE OF CONTENTS

SECTION 7

Data Read/Write Services

- 7-1 About Data Read/Write Services
- 7-2 PC Network Instructions
- 7-3 CV-mode Command/Response Format
- 7-4 CV-mode Command Lists
- 7-5 Response Codes
- 7-6 Memory Area Designations
- 7-7 Volume Labels and File Names
- 7-8 CV-mode Commands for PCs
- 7-9 CV-mode Commands for SYSMAC LINK Units

SECTION 8

Special Services

- 8-1 Remote Programming and Monitoring
- 8-2 Internode Echo Test
- 8-3 Broadcast Test
- 8-4 Error Log
- 8-5 Polling Unit Backup
- 8-6 Node Bypasses

SECTION 9

Error Processing

- 9-1 Troubleshooting
- 9-2 Network Troubleshooting

SECTION 10

Inspection and Maintenance

- 10-1 Periodic Inspection
- 10-2 Replacing SYSMAC LINK Units

Appendices

- A Standard Models
- B Specifications
- C Internal Configuration
- D PC Data Area Information
- E Setting and Startup Procedures

Glossary

Index

Revision History

About this Manual:

This manual describes the installation and operation of CV-series SYSMAC LINK Units and includes the sections described below.

Please read this manual completely and be sure you understand the information provided before attempting to install and operate a SYSMAC LINK System including CV-series SYSMAC LINK Units.

Section 1 Introduction introduces the features and operations possible with SYSMAC LINK Units. It also describes the possible system configurations.

Section 2 Unit Components and Switch Settings presents the names and functions of the SYSMAC LINK Units' components and the switch settings.

Section 3 Installation explains how to install SYSMAC LINK Systems.

Section 4 Basic Communications introduces the token bus method of communications used in SYSMAC LINK Systems and explains the basic settings necessary for operation.

Section 5 Data Links describes the operation of data links, procedures required to establish data links, and methods of monitoring data link operations.

Section 6 Network Data Exchange describes data exchange between different networks, bridges, gateways, and routing tables.

Section 7 Data Read/Write Services describes the data read/write services, which provide data transmission and control operations between nodes. The data read/write services include the NETWORK READ (RECV(193)) and NETWORK WRITE (SEND(192)) instructions, plus CV-mode commands sent via the DELIVER COMMAND (CMND(194)) instruction.

Section 8 Special Services provides information on remote programming and monitoring and RAS functions.

Section 9 Error Processing provides information to help identify and correct errors that might occur in the System.

Section 10 Inspection and Maintenance describes periodic maintenance required by the System and how to replace a SYSMAC LINK Unit.



WARNING

Failure to read and understand the information provided in this manual may result in personal injury or death, damage to the product, or product failure. Please read each section in its entirety and be sure you understand the information provided in the section and related sections before attempting any of the procedures or operations given.

PRECAUTIONS

This section provides general precautions for using the Programmable Controller (PC) and related devices.

The information contained in this section is important for the safe and reliable application of the Programmable Controller. You must read this section and understand the information contained before attempting to set up or operate a PC system.

1 Intended Audience	xii
2 General Precautions	xii
3 Safety Precautions	xii
4 Operating Environment Precautions	xiii
5 Application Precautions	xiii

1 Intended Audience

This manual is intended for the following personnel, who must also have knowledge of electrical systems (an electrical engineer or the equivalent).

- Personnel in charge of installing FA systems.
- Personnel in charge of designing FA systems.
- Personnel in charge of managing FA systems and facilities.

2 General Precautions

The user must operate the product according to the performance specifications described in the operation manuals.





Before using the product under conditions which are not described in the manual or applying the product to nuclear control systems, railroad systems, aviation systems, vehicles, combustion systems, medical equipment, amusement machines, safety equipment, and other systems, machines, and equipment that may have a serious influence on lives and property if used improperly, consult your OMRON representative.

Make sure that the ratings and performance characteristics of the product are sufficient for the systems, machines, and equipment, and be sure to provide the systems, machines, and equipment with double safety mechanisms.

This manual provides information for programming and operating the Unit. Be sure to read this manual before attempting to use the Unit and keep this manual close at hand for reference during operation.

-  **WARNING** It is extremely important that a PC and all PC Units be used for the specified purpose and under the specified conditions, especially in applications that can directly or indirectly affect human life. You must consult with your OMRON representative before applying a PC System to the above-mentioned applications.

3 Safety Precautions

-  **WARNING** Do not attempt to take any Unit apart while the power is being supplied. Doing so may result in electric shock.
-  **WARNING** Do not touch any of the terminals or terminal blocks while the power is being supplied. Doing so may result in electric shock.
-  **WARNING** Do not attempt to disassemble, repair, or modify any Units. Any attempt to do so may result in malfunction, fire, or electric shock.
-  **Caution** Confirm safety at the destination node before transferring a program to another node or changing the I/O memory area. Doing either of these without confirming safety may result in injury.

4 Operating Environment Precautions

-  **Caution** Do not operate the control system in the following places:
- Locations subject to direct sunlight.

- Locations subject to temperatures or humidity outside the range specified in the specifications.
- Locations subject to condensation as the result of severe changes in temperature.
- Locations subject to corrosive or flammable gases.
- Locations subject to dust (especially iron dust) or salts.
- Locations subject to exposure to water, oil, or chemicals.
- Locations subject to shock or vibration.

 **Caution** Take appropriate and sufficient countermeasures when installing systems in the following locations:

- Locations subject to static electricity or other forms of noise.
- Locations subject to strong electromagnetic fields.
- Locations subject to possible exposure to radioactivity.
- Locations close to power supplies.

5 Application Precautions

Observe the following precautions when using the PC System.

 **WARNING** Always heed these precautions. Failure to abide by the following precautions could lead to serious or possibly fatal injury.

- Always connect to a class-3 ground (to 100 Ω or less) when installing the Units. Not connecting to a class-3 ground may result in electric shock.
- Always turn OFF the power supply to the PC before attempting any of the following. Not turning OFF the power supply may result in malfunction or electric shock.
 - Mounting or dismounting Units.
 - Assembling the Units.
 - Setting DIP switches or rotary switches.
 - Connecting or wiring the cables.
 - Connecting or disconnecting the connectors.

 **Caution** Failure to abide by the following precautions could lead to faulty operation of the PC or the system, or could damage the PC or PC Units. Always heed these precautions.

- Fail-safe measures must be taken by the customer to ensure safety in the event of incorrect, missing, or abnormal signals caused by broken signal lines, momentary power interruptions, or other causes.
- Interlock circuits, limit circuits, and similar safety measures in external circuits (i.e., not in the Programmable Controller) must be provided by the customer.
- Always use the power supply voltage specified in the operation manuals. An incorrect voltage may result in malfunction or burning.
- Take appropriate measures to ensure that the specified power with the rated voltage and frequency is supplied. Be particularly careful in places where the power supply is unstable. An incorrect power supply may result in malfunction.
- Install external breakers and take other safety measures against short-circuiting in external wiring. Insufficient safety measures against short-circuiting may result in burning.
- Disconnect the functional ground terminal when performing withstand voltage tests. Not disconnecting the functional ground terminal may result in burning.

- Install the Unit properly as specified in the operation manual. Improper installation of the Unit may result in malfunction.
- Be sure that all the mounting screws, terminal screws, and cable connector screws are tightened to the torque specified in the relevant manuals. Incorrect tightening torque may result in malfunction.
- Leave the label attached to the Unit when wiring. Removing the label may result in malfunction.
- Remove the label after the completion of wiring to ensure proper heat dissipation. Leaving the label attached may result in malfunction.
- Use crimp terminals for wiring. Do not connect bare stranded wires directly to terminals. Connection of bare stranded wires may result in burning.
- Double-check all the wiring before turning ON the power supply. Incorrect wiring may result in burning.
- Mount the Unit only after checking the terminal block completely.
- Be sure that the terminal blocks, Memory Units, expansion cables, and other items with locking devices are properly locked into place. Improper locking may result in malfunction.
- Check the user program for proper execution before actually running it on the Unit. Not checking the program may result in an unexpected operation.
- Confirm that no adverse effect will occur in the system before attempting any of the following. Not doing so may result in an unexpected operation.
 - Changing the operating mode of the PC.
 - Force-setting/force-resetting any bit in memory.
 - Changing the present value of any word or any set value in memory.
- Resume operation only after transferring to the new CPU Unit the contents of the DM and HR Areas required for resuming operation. Not doing so may result in an unexpected operation.
- Do not pull on the cables or bend the cables beyond their natural limit. Doing either of these may break the cables.
- Do not place objects on top of the cables. Doing so may break the cables.
- When replacing parts, be sure to confirm that the rating of a new part is correct. Not doing so may result in malfunction or burning.
- Before touching the Unit, be sure to first touch a grounded metallic object in order to discharge any static built-up. Not doing so may result in malfunction or damage.

SECTION 1

Introduction

This section introduces the features and operations of the SYSMAC LINK Units.

1-1	OMRON Network Systems	2
1-2	SYSMAC LINK System Features	2
1-3	System Configuration	4
1-3-1	Single-level Systems	4
1-3-2	Multilevel System	5
1-3-3	Connection between Networks	6

1-1 OMRON Network Systems

As production processes become more complex and diversified, it is necessary to develop networks that link control components such as PCs to more powerful host computers in LANs that control entire production processes.

OMRON provides 3 types of network systems for large, medium, and small-scale networks.

SYSMAC NET Link System The SYSMAC NET Link System is a high-speed, high-capacity LAN. It can be used as a gateway to a general LAN composed of different kinds of computers or to an ethernet to create a large-scale network.

SYSMAC LINK System The SYSMAC LINK System provides high-speed, high-capacity communications between any nodes (PCs or host computers) in the network, as well as remote monitoring and programming functions and automatic data transfer via data links.

SYSMAC BUS/2 System The SYSMAC BUS/2 System is used to link a single PC to remote racks called Slave Racks and/or other Slaves (e.g., I/O Terminals or Programmable Terminals) to form a small, decentralized control network.

Depending on the size and complexity of the production process, these systems can be used alone or in combination as shown below.

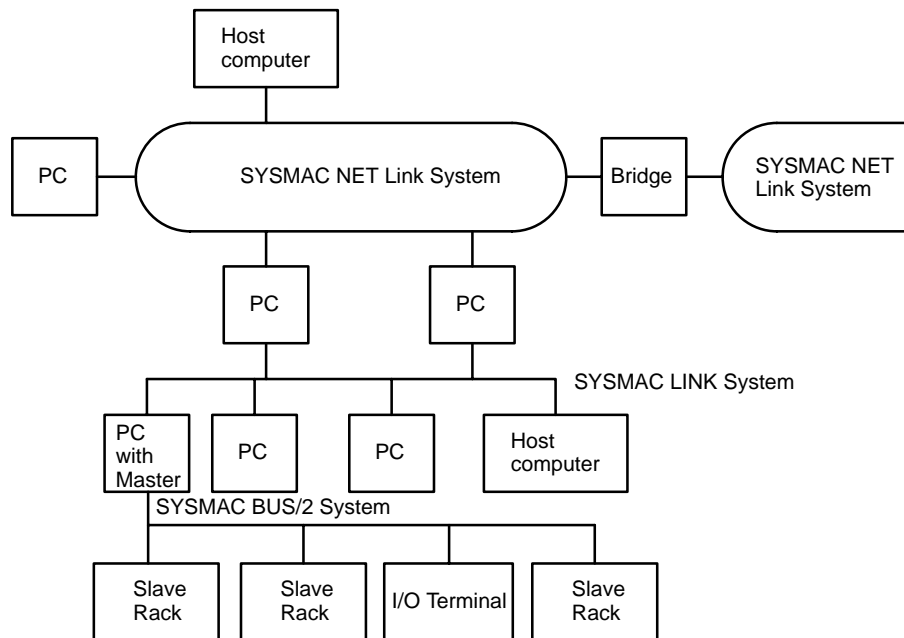

1-2 SYSMAC LINK System Features

CV-series SYSMAC LINK Units are equipped with a variety of special features including some developed from those incorporated by the C-series SYSMAC LINK Unit. These features allow PCs in a SYSMAC LINK Network to communicate with or automatically exchange data with other PCs in the same Network and to communicate with interconnected Networks.

High Speed, Reliability, and Flexibility

The specialized communications LSIs used in all SYSMAC LINK Units deliver high speed, reliability, and flexibility in an advanced data link system, while optical fiber cable systems provide high-speed communications with unparalleled immunity to noise.

In the event of an error or failure in the polling unit, another node automatically takes over management of the SYSMAC LINK System without stopping the entire network. A single IBM AT/PC or compatible running CVSS can monitor and/or program PCs anywhere in the network via the SYSMAC LINK System.

Distributed Control with Data Links

The data link function transfers data to and from other nodes automatically, establishing simple but powerful peer-to-peer links between nodes. Data links can be generated automatically or the user can use the flexibility of manually generating data links to eliminate unused link words, improve data link I/O response time, and to even create several data link groups in one network.

The data link communications cycle time can be fixed at a constant value, so even simultaneous remote programming/monitoring and NETWORK READ/ WRITE instructions (RECV(193)/SEND(192)) execution have no effect on the data link I/O response time.

The data link function allows data exchange not only between PCs but also between PCs and host computers in the network, making it possible to develop communications software with ease.

Active Communications

Communications can also be programmed using ladder-diagram instructions (SEND(193), RECV(193), and CMND(194)) to facilitate communications with other PCs and host computers on an as-needed basis. Use of these instructions enables the following:

- 1, 2, 3...**
1. Broadcast transmissions
 2. Response monitoring time setting (response time-out setting)
 3. Transmit retry setting
 4. Enabling/disabling responses

Inter-network Communications

Routing tables can be set up in network PCs so that communications are possible with interconnecting networks or networks one network away from the local network. This includes both bridging to other SYSMAC LINK Networks or passing gateways to other OMRON networks, including those in SYSMAC NET Link Systems or SYSMAC BUS/2 Remote I/O Systems.

Remote Access

IBM AT/PC or compatibles running CVSS can access PCs on the local network, on adjacent networks, or on networks one removed from the local network, including SYSMAC NET, SYSMAC LINK, and SYSMAC BUS/2 Systems. Access can be used to monitor operation and/or manipulate data and programs.

RAS Functions

SYSMAC LINK Units are equipped with three RAS functions (RAS is an acronym for reliability, availability, and serviceability). The Polling Unit Backup and Failed Node Bypass (optical systems only) functions prevent the network from failing when one Unit fails. The Internode Echo Test function aids in communications troubleshooting.

Remote monitoring of the network's operating status and error logs also aids in troubleshooting and quick correction of communications problems.

New Capabilities

The ability to receive CV-mode commands from CV-series PCs has been added to the C1000H-SLK11/SLK21-V1 and C200H-SLK11/SLK21-V1 SYSMAC LINK Units for the C-series PCs. With the CV-mode commands, C-series PCs with these SYSMAC LINK Units can be communicate with CV-series PCs or host computers via the SYSMAC LINK Network.

1-3 System Configuration

Up to 62 nodes (including all PCs and, in coaxial systems, computers) can be connected in a SYSMAC LINK Network via SYSMAC LINK Units or Network Service Boards. One of the Units in the network will function as the polling unit and the remainder will be polled units. The polling unit manages the System communications during and after configuration.

Note Refer to *Appendix E SYSMAC LINK Setting and Startup Procedure* for the overall setting and startup procedures.

1-3-1 Single-level Systems

The following diagrams show the general configuration of Single-level SYSMAC LINK Systems connected with coaxial and optical fiber cables. The Systems are considered single-level because each PC has only one SYSMAC LINK Units mounted to it.

The CVSS connection is not a required part of the System. It is shown here because of its usefulness in monitoring and controlling not only the operation of the SYSMAC LINK System itself, but the general operation of all the PCs connected in the System.

Coaxial System

The abbreviation NSB indicates a SYSMAC LINK Network Service Board, which is required to connect a computer to the network.

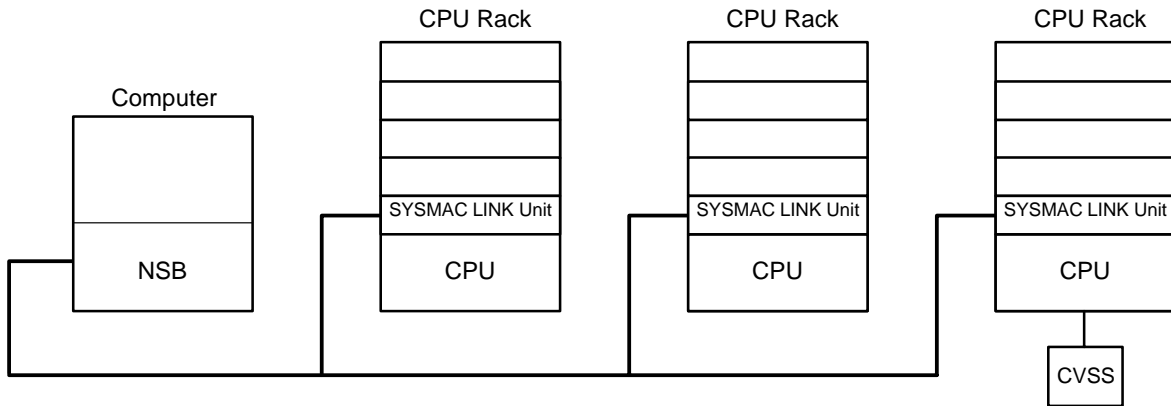

Note Terminator must be connected to the Units on the ends of the network.

Optical System

The abbreviation APS indicates an Auxiliary Power Supply Unit.

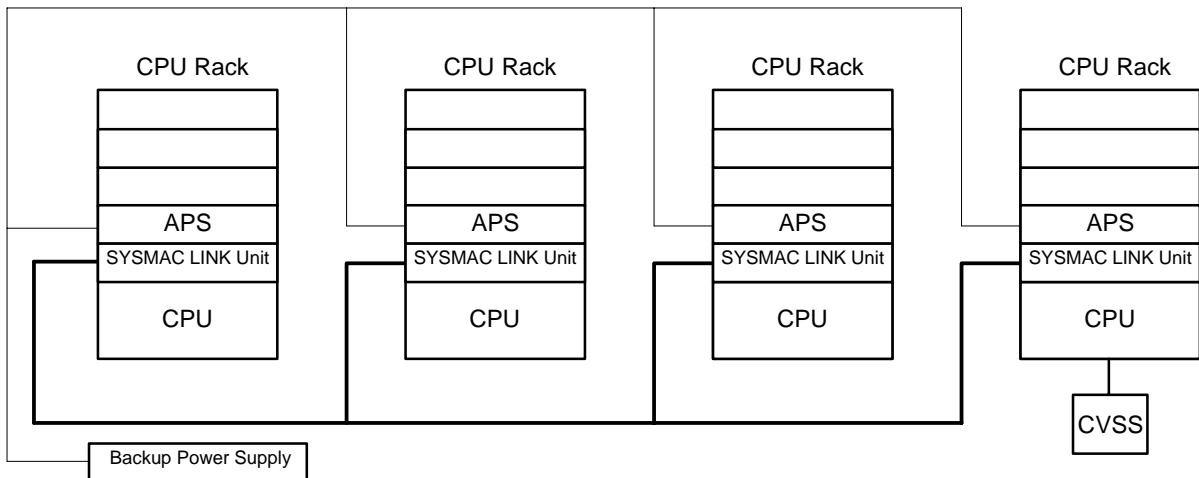

1-3-2 Multilevel System

Each PC can have up to four SYSMAC LINK Units mounted. Each SYSMAC LINK Unit will connect it to a SYSMAC LINK Network, e.g., if a PC has two SYSMAC LINK Units mounted, it is part of two SYSMAC LINK Networks and the overall system is considered a Multilevel SYSMAC LINK System. Operating levels, which are described later in this manual, are used to differentiate between the two Networks to which one PC might belong.

The CVSS connection is not a required part of the System. It is shown here because of its usefulness in monitoring and controlling not only the operation of the SYSMAC LINK System itself, but the general operation of all the PCs connected in the same Network(s) as the PC to which the CVSS is connected.

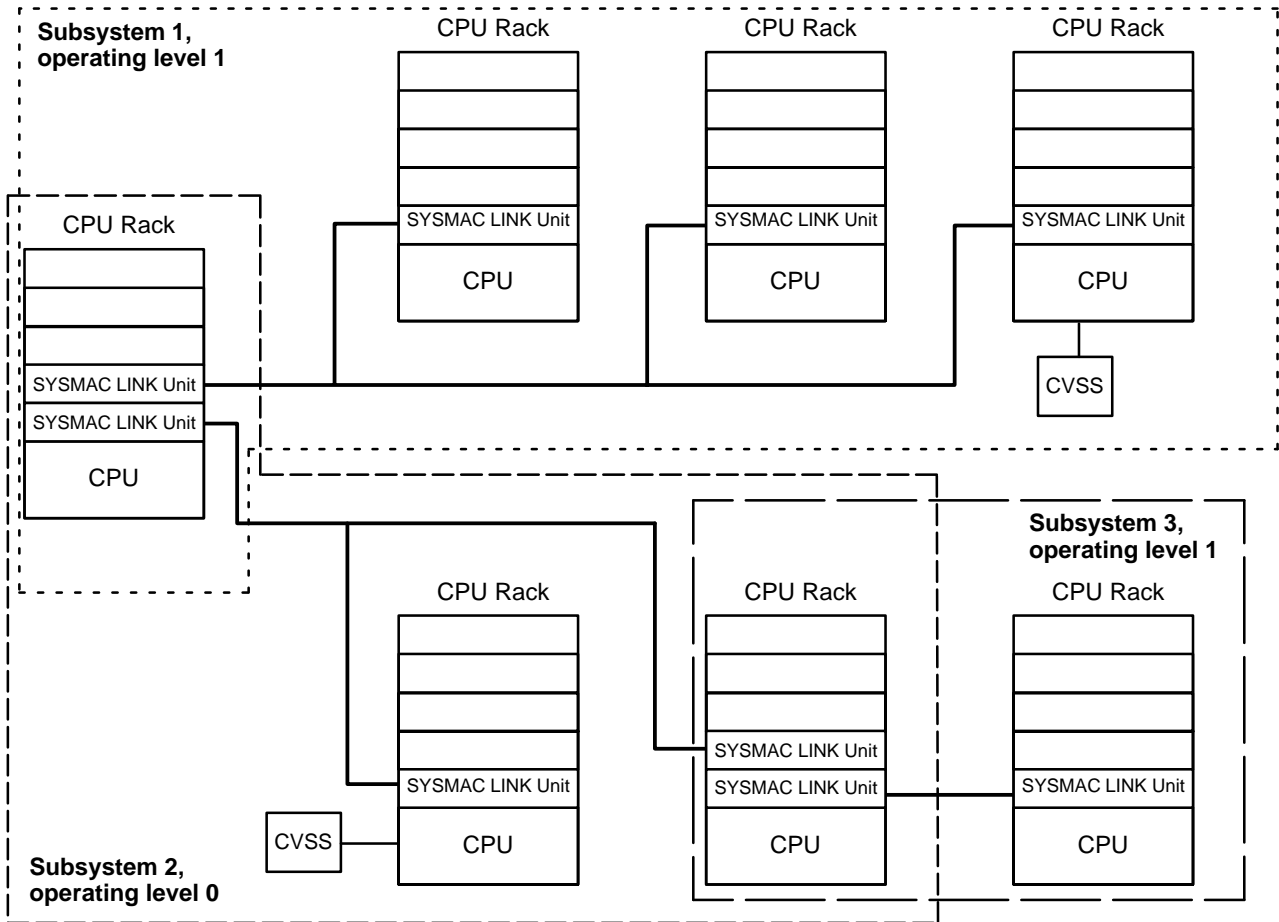

Note Terminator must be connected to the Units on the ends of networks connected by coaxial cable.

1-3-3 Connection between Networks

The SYSMAC CV-series PC's bridge and gateway function allow a network to communicate with other networks. The local node can exchange data with a destination node even with another network between them, thus making it possible to construct a sophisticated network that controls a variety of lines with ease.

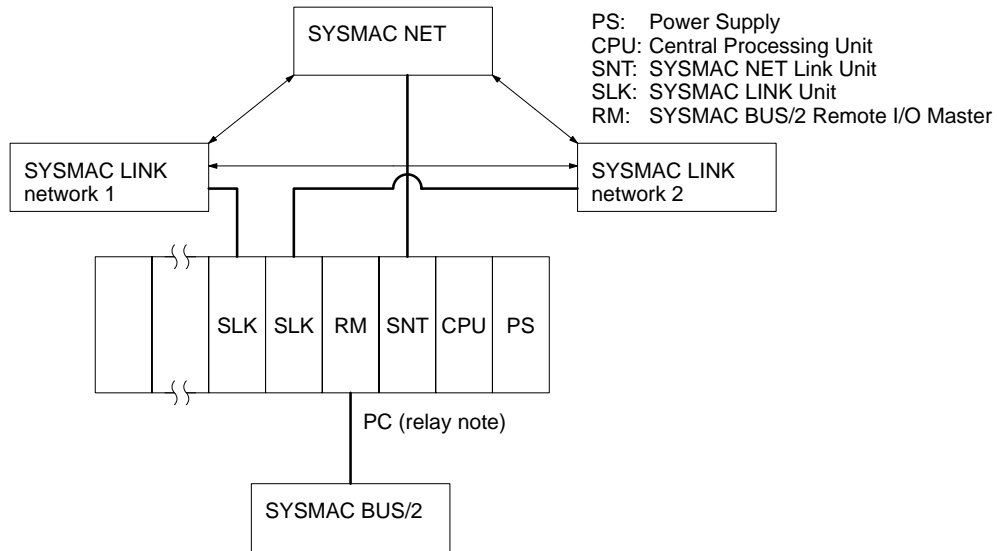

SECTION 2

Unit Components and Switch Settings

The names and functions of the SYSMAC LINK Units' components and switch settings are described in this section.

2-1	Nomenclature	8
2-2	Indicators and Switch Settings	9
2-2-1	Indicators	9
2-2-2	Rotary Switches	10
2-2-3	System Settings	10
2-3	Mounting Units	11
2-4	Unit Dimensions	12

2-1 Nomenclature

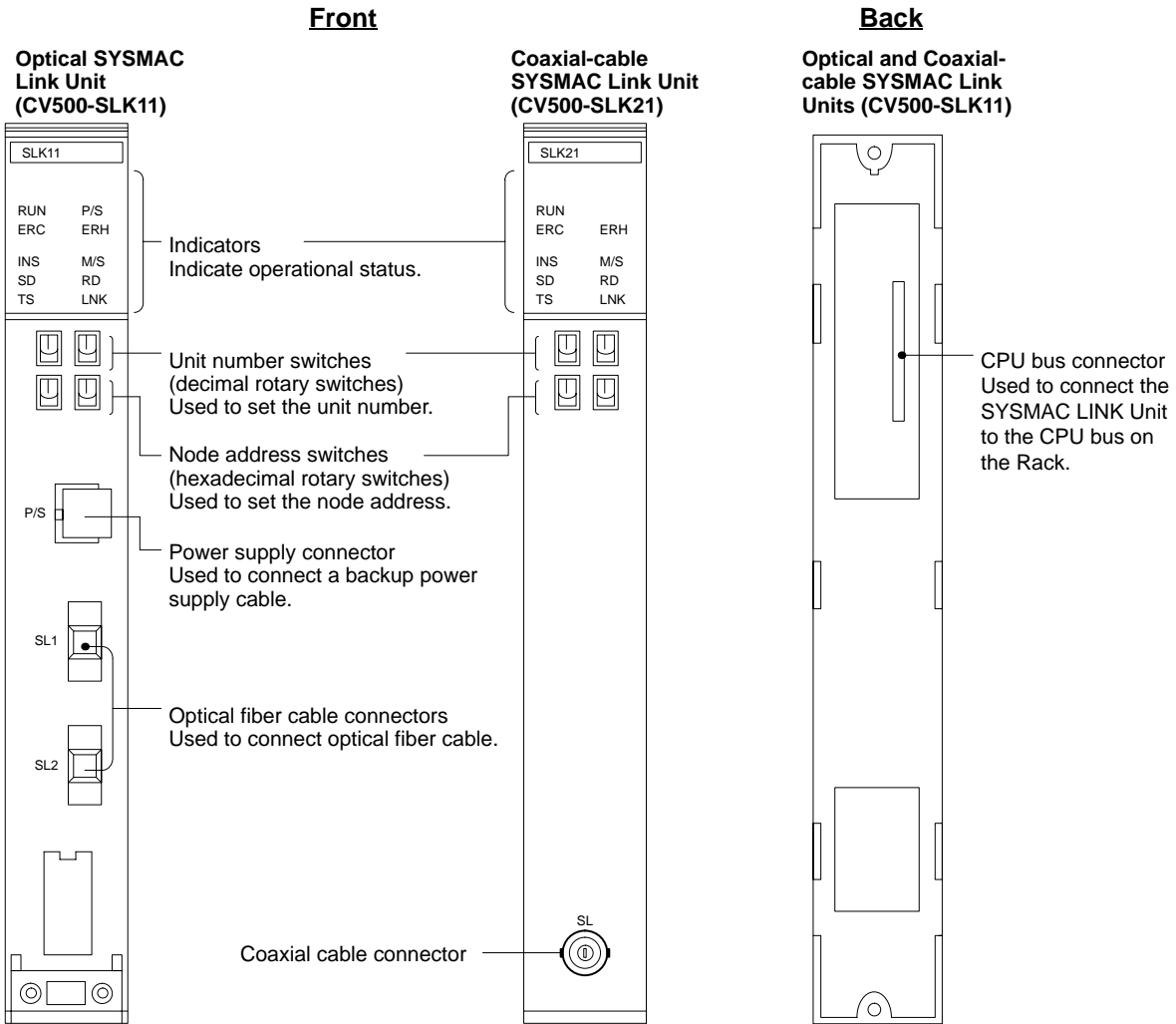

2-2 Indicators and Switch Settings

2-2-1 Indicators

The status of the SYSMAC LINK Units is shown by the indicators listed below. Units connected with coaxial cable (CV500-SLK21) are not equipped with the P/S indicator.

Optical SYSMAC Link Unit (CV500-SLK11)

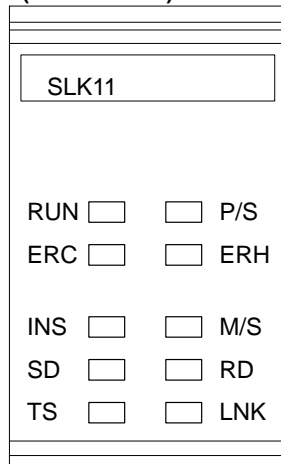

Coaxial-cable SYSMAC Link Unit (CV500-SLK21)

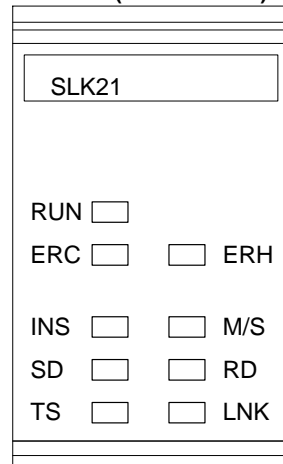

Indicator name	Color	Condition	Meaning
RUN	Green	Lit	Unit is operating normally.
		Not lit	Watchdog timer error has occurred.
P/S (power supply on, Optical Units only)	Green	Lit	Power is being supplied from the Auxiliary Power Supply Unit.
		Not lit	Power is not being supplied from the Auxiliary Power Supply Unit.
ERC (communications error)	Red	Lit	Communications error has occurred, node address setting is incorrect, or same node address has been set twice.
		Not lit	None of the above errors has occurred.
ERH (PC error)	Red	Lit	No I/O table has been set or PC CPU, PC model, PC version, PC interface, EEPROM, unit number setting, or a unit number duplication error has occurred.
		Not lit	None of the above errors has occurred.
INS (Network inclusion)	Orange	Lit	Unit is part of Network.
		Not lit	Unit is not part of Network.
M/S (polling unit)	Orange	Lit	Unit is polling unit.
		Not lit	Unit is not part of Network or is polled unit.
SD (transfer)	Orange	Lit	Unit is sending data.
		Not lit	Unit is not sending data.
RD (receive)	Orange	Lit	Unit is receiving data.
		Not lit	Unit is not receiving data
TS (test)	Orange	Lit	Test is being executed.
		Flashing	Test setting error has occurred.
		Not lit	Test is not being executed.
LNK (data link)	Orange	Lit	Unit is part of active data link.
		Flashing	Data link error has occurred.
		Not lit	Unit is not part of active data link.

2-2-2 Rotary Switches

The SYSMAC LINK Unit provides decimal rotary switches on the front panel with which you set the node address (“NODE NO.”) and unit number. You must turn off the PC when setting the rotary switches. If you have changed the settings when the PC is not turned off, you must restart the SYSMAC LINK Unit or the PC to use the new settings.

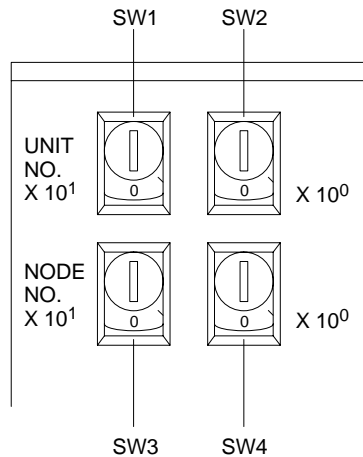

Set the unit number with SW1 and SW2. Set the node address with SW3 and SW4. The setting ranges are as follows:

Switches	Range	Remarks
SW1 and SW2 for unit number	00 to 15 (decimal)	Each unit number in a CPU must have a unique number.
SW3 and SW4 for node address	01 to 62 (decimal)	Each node address in a network must have a unique address.

2-2-3 System Settings

The initial settings of the SYSMAC LINK Unit are done according to the data stored in the PC. If the settings are changed while power is ON, restart the PC or SYSMAC LINK Unit to make the new settings effective. Refer to the CVSS manuals for procedures and set the following. Refer to *Appendix E SYSMAC LINK Setting and Startup Procedure* for an overview of the required settings.

- 1, 2, 3...
1. Polling/Polled Unit Setting
Normally designate the SYSMAC LINK Unit as a polling unit. When the designated SYSMAC LINK Unit participates in a network that already has a polling unit, the SYSMAC LINK Unit will be treated as a polled unit. The setting is not effective if the SYSMAC LINK Unit is not turned on.
 2. Data Link Area (Automatic/Manual Setting)
Select the method of setting data links for the PC (automatic settings or manual settings from the CVSS). If automatic setting of the data links is selected, the memory areas (CIO Area and/ or DM Area) must be specified. The settings are effective only on the polling unit.
 3. Area Word
Designates the number of data link words per node when automatic setting of the data link area is selected. The settings are effective only on the polling unit.

2-3 Mounting Units

You can mount SYSMAC Link Units to the Backplane of the CPU or Expansion CPU Rack of a CV-series PC.

Mounting to Backplane

Mount up to four CV500-SLK21 and/or CV500-SLK11 SYSMAC Link Units to the CV500-BC101/051/031 CPU Backplane and/or CV500-BC111 Expansion CPU Backplane as shown in the following illustration.

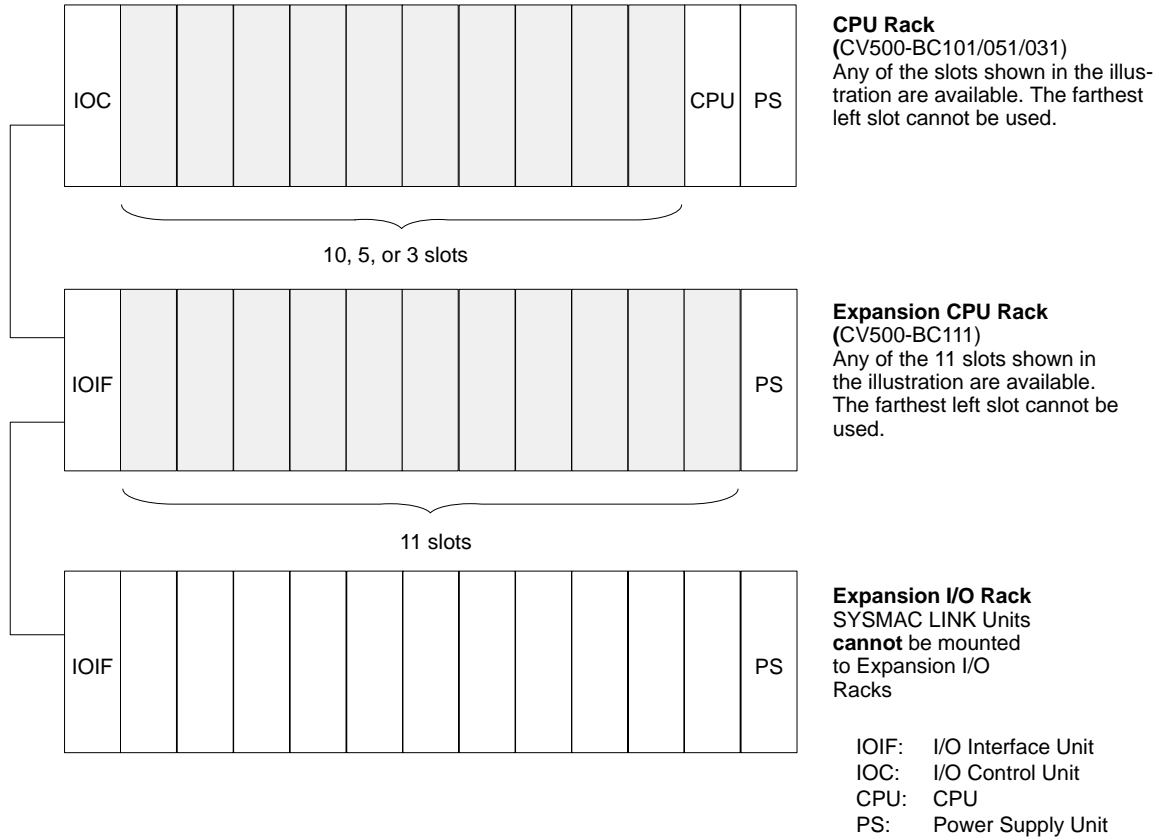

The CVM1-BC103/053 CPU Backplanes can also be used, but the Unit must be mounted to the rightmost 6 slots on the CVM1-BC103 or to the rightmost 3 slots on the CVM1-BC053.

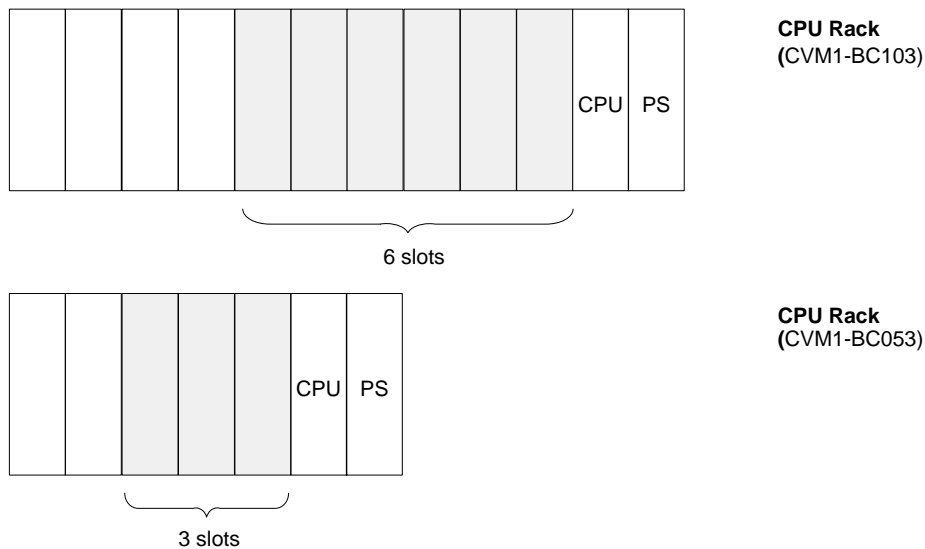

2-4 Unit Dimensions

Optical SYSMAC LINK Units (C500-SLK11)

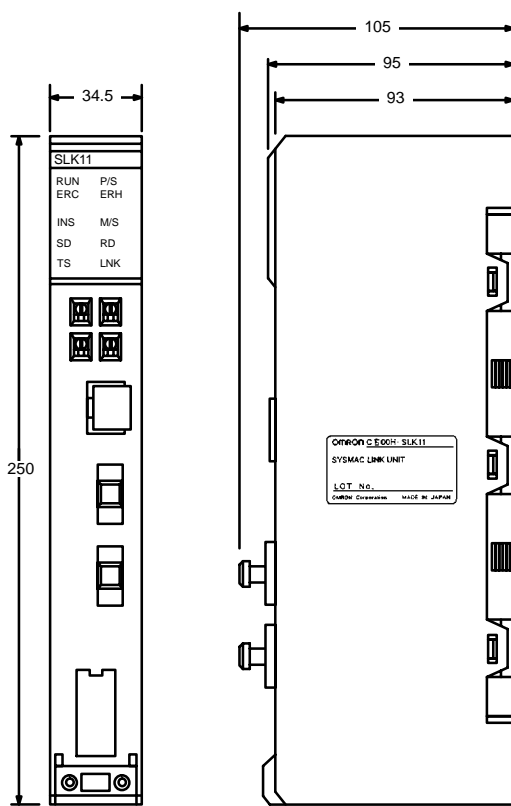
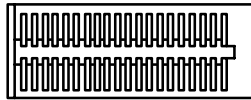

Coaxial-cable SYSMAC LINK Units (C500-SLK21)

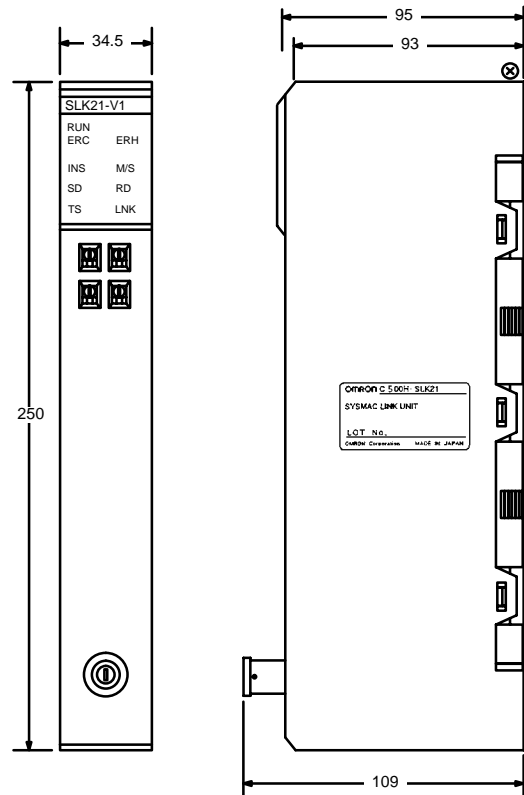
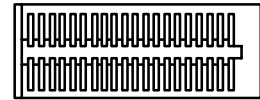

SECTION 3

Installation

This section explains how to install SYSMAC LINK Systems.

3-1	Cable Connection	14
3-1-1	Coaxial Cable	14
3-1-2	Optical Fiber Cable	15
3-2	Power Supply Unit Connection	18
3-2-1	Specifications and Components	19
3-2-2	Installation and Wiring	20

3-1 Cable Connection

SYSMAC LINK Units can be connected with either coaxial cable or optical fiber cable. This section describes the procedures required to connect these cables.

3-1-1 Coaxial Cable

The diagram below shows a SYSMAC LINK System connected by coaxial cable.

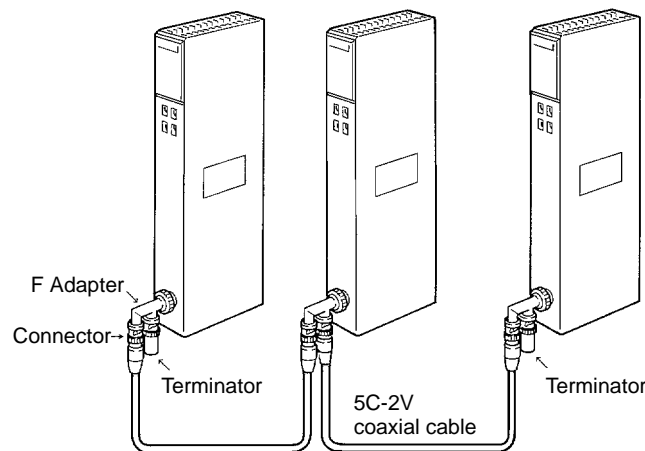

Required Components

- 1, 2, 3...**
1. Coaxial cable and connectors:

Use the 5C-2V coaxial cable designed for indoor use. Install connectors on each end of the cable. Cables must be continuous. No intervening cable connectors or breaks are permitted.
 2. F Adapters (C1000H-CE001):

Coaxial cables are connected to the SYSMAC LINK Units via F Adapters. One F Adapter is included as an accessory with SYSMAC LINK Units that use coaxial cables (CV500-SLK21).
 3. Terminator (C1000H-TER01):

Two Terminator units (sold separately) are required, one for the F Adapter at each end of the network.

Connection Procedure

The connection procedure is described briefly below.

- 1, 2, 3...**
1. Install connectors on each end of the cables.
 2. Connect Terminator to the F Adapter at each end of the network (i.e., to the unused connectors at the last Unit on each end). Hold the connector in one hand and press the resistance into it firmly with the other.

- Connect the F Adaptors to the SYSMAC LINK Units by firmly pushing the adapter onto the coaxial connector on the Unit and turning the locking ring to the right until it locks. Start at one end of the network and connect the F Adaptors to the other end in order.

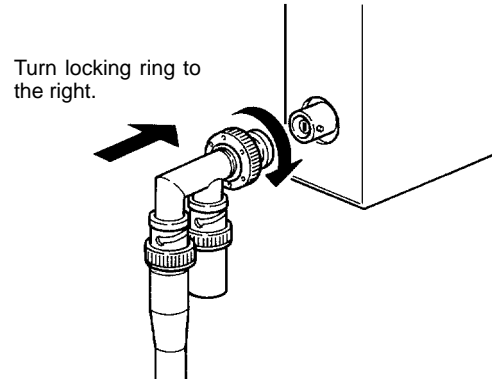

- Place an insulation cover over the F Adapter.

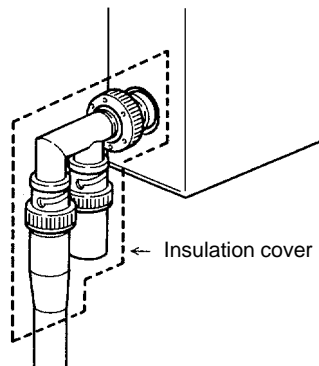

- Any bends in the coaxial cable must be 45 mm in radius or greater (six times the outer diameter of the cable). When laying the cable, make bends of 110 mm in radius or greater (15 times the outer diameter of the cable).

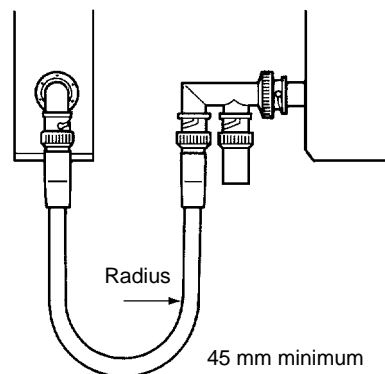

3-1-2 Optical Fiber Cable

Required Components

- 1, 2, 3... 1. Optical fiber cable:
Use Hard Plastic-clad Optical Fiber Cable (H-PCF). Refer to *Appendix A Standard Models* for details on available lengths and colors.

2. Optical Connectors:

There are two types of Optical Connector available, as shown in the following table. Use the cable splicing connector to splice cable.

Function	Model	Number required
Node-cable connection	S3200-COCF2011	2 for each node
Cable splicing	S3200-COIAT2000 (Inline Adapter)	1 for each break in the cable

Note Using an Inline Adapter to splice the cable will reduce the maximum transmission distance because of loss at the junction. Refer to your hard plastic-clad optical fiber cable (H-PCF) installation manual for details.

3. Optical Connector Assembly Tool Set

These tools are required to attach the Optical Fiber Cable to the Optical Connector.

Optical Connector Assembly Tool Set
S3200-CAK1062 (Includes the S3200-FC7155 Optical Fiber Cable Cutter)

4. Optical Fiber Tester (Optical Power Tester)

Tester Set	Head Unit	Applicable Connector
S3200-CAT2700	S3200-CAT2702	S3200-COCF2011

5. Master Fiber

Master Fiber	Applicable Connector
S3200-CAT2001H	S3200-COCF2011

Optical Connector Assembly

Follow the instructions provided with the S3200-CAK1062 Optical Connector Assembly Tool Set.

Connection Procedure

The connection procedure is described briefly below. Begin with the highest node in the network and connect the lower nodes in order.

- 1, 2, 3...**
1. Insert the terminals into the mounting bracket so that the tension wire holes are vertical, and then secure the terminals by tightening the nuts on the other side.
 2. Insert the bushings into the mounting bracket and secure the bracket to the Unit with the Phillips head screws provided.
 3. If the cable has tension wires, thread them through the terminals and tighten the terminal screws to secure them.
 4. Place the cables behind the clamp and secure them by tightening the Phillips head screw provided. Secure both cables at once.

5. Align the cable's Optical Connectors so that the tabs are on the left and insert them into the Unit's Optical Connectors.

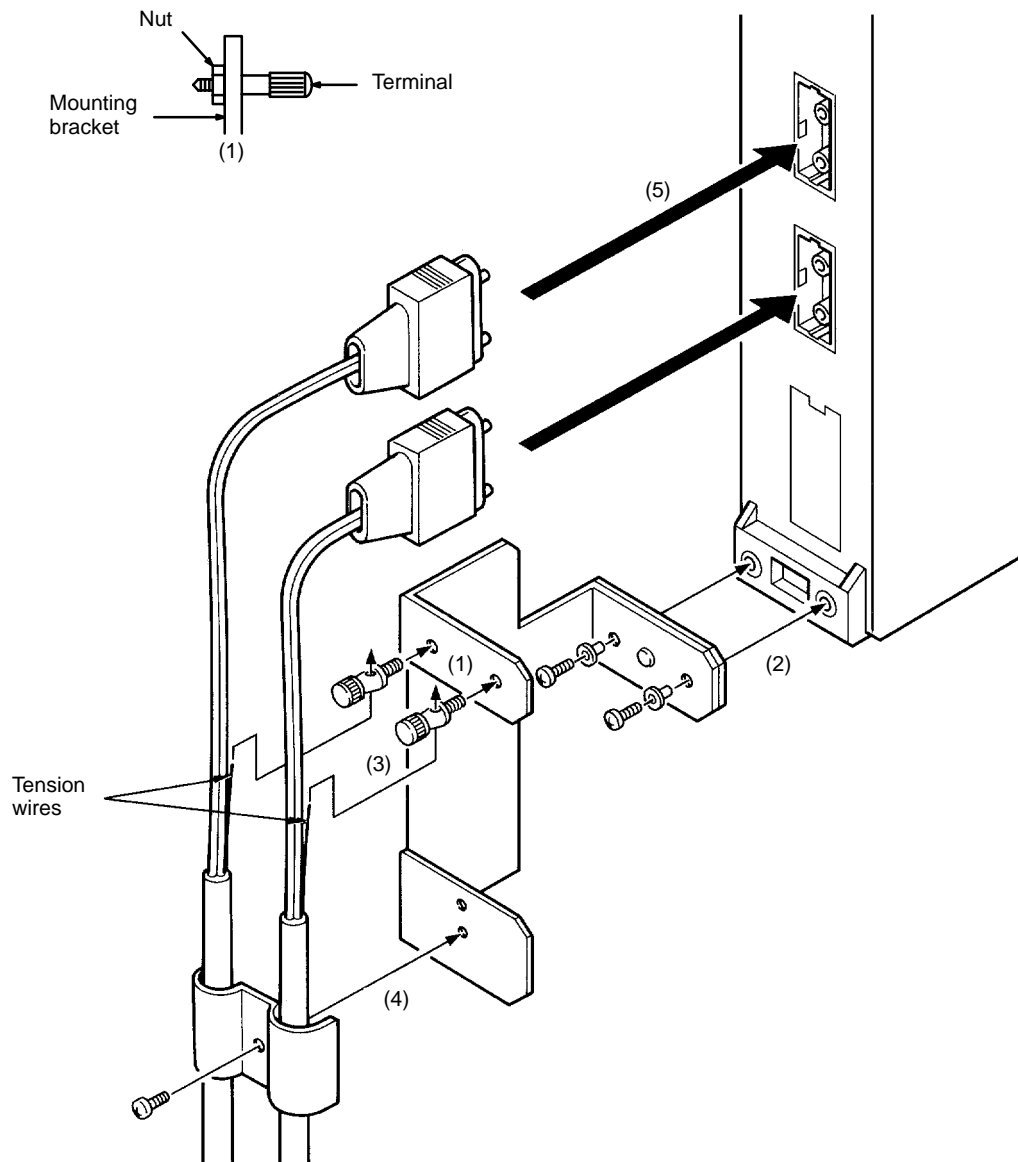

Precautions

- 1, 2, 3...
 1. Use only the Hard Plastic-clad Optical Fiber Cable (H-PCF) listed in *Appendix A Standard Models*.
 2. Any bends in the cable must be 10 cm in radius or greater.
 3. Always hold the connector firmly when inserting or removing the cables.

- As shown in the diagram below, begin connecting the highest node of the network and connect the lower nodes in order. Cover the upper connector (SL1) of the highest node, and connect SL2 to SL1 of the next node. Continue connecting this way until the lowest node is reached and cover SL2 of the lowest node.

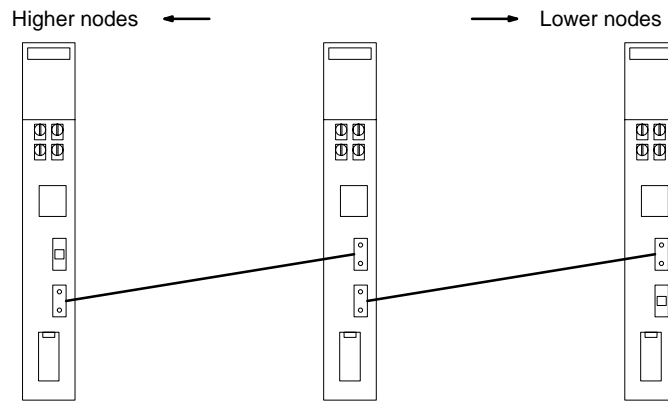

- Allow sufficient clearance between the bottom of the Unit and the cable to prevent the cable from being bent too much, as shown in the diagram below. (The clearances are in millimeters.)

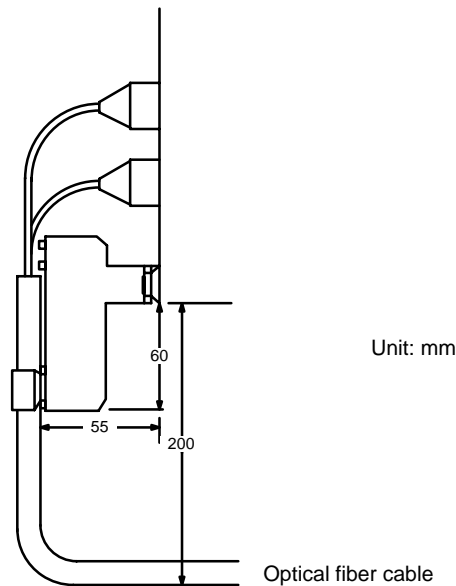

3-2 Power Supply Unit Connection

Optical SYSMAC LINK Units (CV500-SLK11) can be connected to the C1000H-APS01 Auxiliary Power Supply Unit to provide backup power. By connecting a SYSMAC LINK Unit to the Auxiliary Power Supply Unit, the overall system will continue to operate even if the Unit fails. Each Auxiliary Power Supply Unit can supply backup power to two SYSMAC LINK Units.

Note Always supply power to the Auxiliary Power Supply Unit from a source different than that used for the Racks and turn on the power supply to the Auxiliary Power Supply Unit first. If the same source is used for both the Racks and the Unit, the backup function of the Unit will be nullified.

3-2-1 Specifications and Components

Specifications

The following specifications apply to the C1000H-APS01.

Item	Specification
Power supply voltage	100 to 120 VAC or 200 to 240 VAC (switchable)
Acceptable voltage range	85 to 132 VAC or 170 to 264 VAC
Power consumption	40 VA max.
Weight	0.5 kg max.
Other	Conform to SYSMAC C-series specifications

Auxiliary Power Supply Unit Components (C1000H-APS01)

The diagram below shows the components of the C1000H-APS01 Auxiliary Power Supply Unit and their functions.

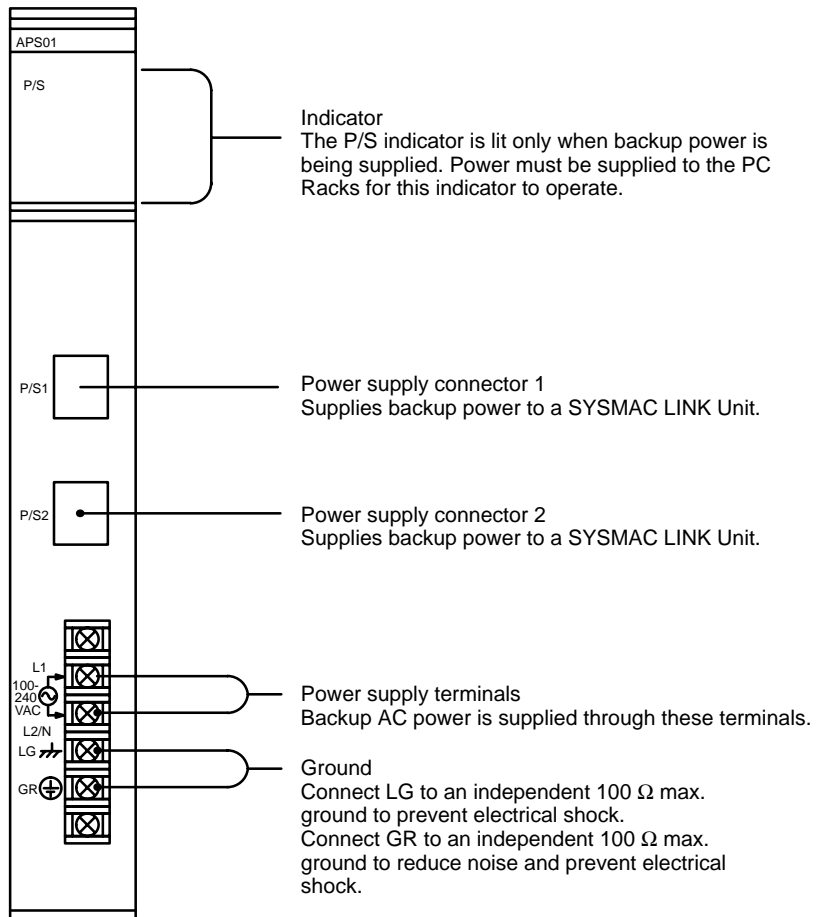

Power Cables

The C1000H-APS01 is provided with a cable (C1000H-CN111). If you are going to provide backup power to two SYSMAC LINK Units, order one more cable separately.

3-2-2 Installation and Wiring

Mounting Position

The C1000H-APS01 can be mounted in any slot, but the power cables are relatively short, so the Auxiliary Power Supply Unit cannot be more than 2 slots from the SYSMAC LINK Unit. One Power Supply Unit can supply backup power to two SYSMAC LINK Units, as shown below.

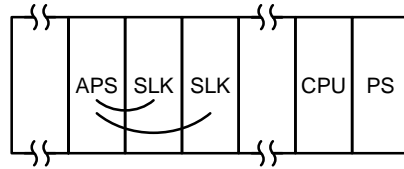

Wiring

The Power Supply Unit and SYSMAC LINK Unit are connected by a power supply cable, as shown below. The cable can be plugged into either power supply connector on the Power Supply Unit.

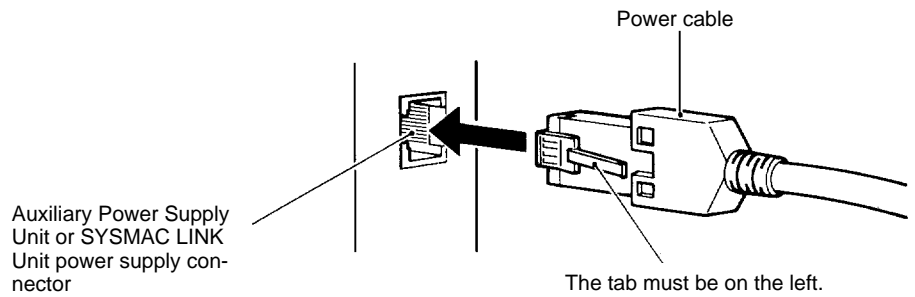

SECTION 4

Basic Communications

A description of the token bus method of communications used in SYSMAC LINK Systems is described briefly in this section, as well as the basic settings necessary for operation.

4-1	SYSMAC LINK System Communications	22
4-2	Unit Number	23
4-3	Setting Node Addresses	24
4-4	Network Address Setting	25
4-5	Network Parameters	25
4-6	Memory Areas	26
4-6-1	Word Allocation	26
4-6-2	Word Application	28

4-1 SYSMAC LINK System Communications

SYSMAC LINK Units communicate through the SYSMAC LINK Network, a token bus LAN. This section describes the **token bus communications** used in the SYSMAC LINK Network.

Token Bus Communications In token bus communications, individual nodes are connected to a main trunk line as a common bus line, as shown in the figure below.

To avoid having two nodes attempt to transmit simultaneously, only one node has the right to transmit at a time. The right to transmit is held by the node which holds what is call the **token**, which is passed in sequence from the node to node, beginning with the node with the lowest node address (the node of the polling unit, see below).

If the token is passed to a node that doesn't have data to transmit, the token is immediately passed to the node with the next higher node address. The node with the highest node address passes the token back to the node with the lowest node address. In this way, each node in the network has its turn to transmit data without interfering with other nodes.

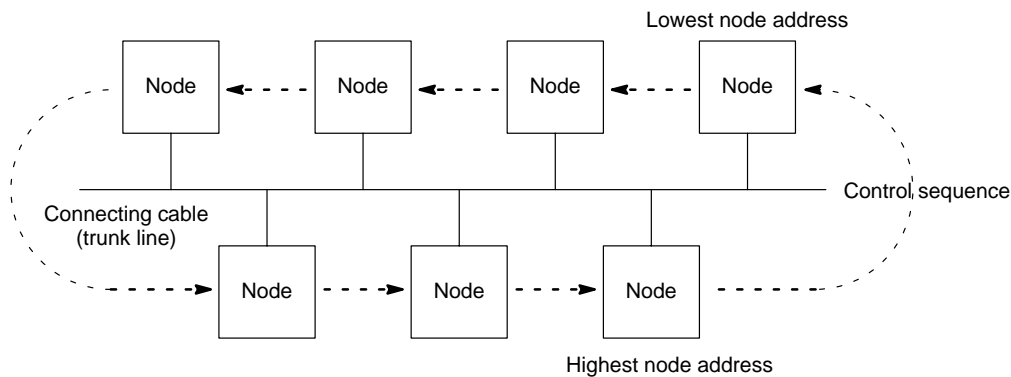

Polling Unit

In a SYSMAC LINK Network there is one node, called the **polling unit**, that controls communications in the network. Normally, the Unit with the lowest node address is the polling unit. If the polling unit fails, the node with the next higher node address automatically becomes the polling unit, preventing the whole network from failing.

Start-up Node

The node that starts the data link in a SYSMAC LINK Network is called the **start-up node**. The data link operates using the settings in the memory area of the PC at the start-up node. With automatic allocation of link words the settings in the communications unit settings are used, and with manual allocation the common link parameters in the start-up node are used.

Communications Cycle

The token in a SYSMAC LINK Network is first passed from the polling unit. The token is passed in sequence from node to node by node address until it is finally returned to the polling unit. One complete circuit around the network is known as a **token cycle**.

At the end of each token cycle, the polling unit polls all of the nodes in the network to check whether any nodes have been added to or removed from the network. The updated information on the network is transmitted to all nodes. This polling and updating process is known as the **polling cycle**.

When the control cycle is completed, the polling unit once again passes the token, beginning the next token cycle. Together the token cycle and control cycle make up the communications cycle, and the time required for the communications cycle is known as the **communications cycle time**.

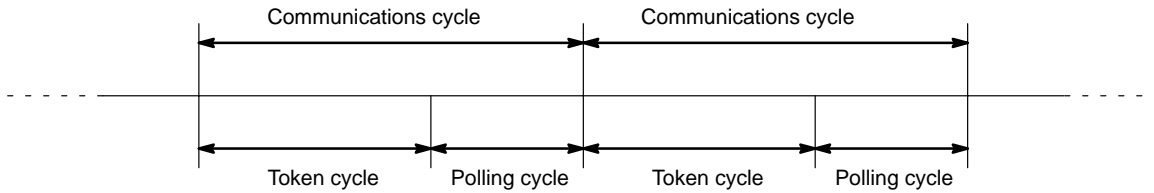

Network Parameters

The communications cycle time is one of the network parameters. The other network parameters are the number of polled units, maximum number of frames, and the maximum node address. These parameters are transmitted from the polling unit to the other nodes in the network. Refer to 4-5 *Network Parameters* for details on the network parameters.

4-2 Unit Number

It is possible to mount up to four SYSMAC LINK Units on a CV-series PC and connect each Unit to a different network. Because the PC incorporates a bridge function and gateway function, it is possible for these networks to exchange data via the PC. If more than one SYSMAC LINK Unit or other CPU Bus Unit is mounted on a single PC, however, each Unit needs a unit number for identification.

Setting

Use the rotary switches (SW1 and SW2) on the front panel to set the unit number. Set the ten's digit with SW1 and the one's digit with SW2. The following illustrations show the unit number set to 6 and 12 with SW1 and SW2.

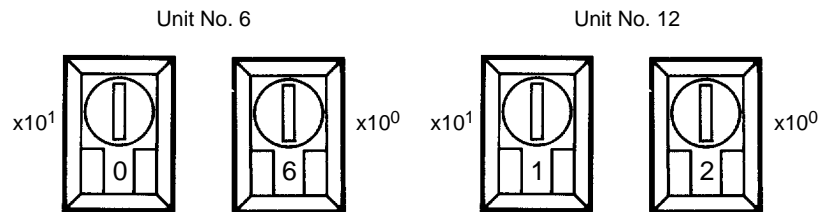

Setting Value Range

It is possible to mount a total of 16 SYSMAC LINK Units and/or other CPU Bus Units on a single PC, out of which, however, the number of SYSMAC LINK Units must not be more than 4.

- Note**
1. All unit numbers must be between 00 and 15 or an error will result and the ERH indicator on the front panel will be lit.
 2. Each Unit connected to the same PC must have a unique number.
 3. Turn off the PC when setting the rotary switches.
 4. If the unit number of any node has been changed, the I/O table on the PC must be generated again and that node must be turned on after all other nodes have been turned on.

Unit Address

When using message services, a unit address is necessary for each device connected to the SYSMAC LINK Unit. The PC's CPU and any NSB connected to the CPU also have unit addresses. The unit address is automatically allocated according to the unit number and/or the type of device. The following table shows the unit address (hexadecimal) calculations from the unit numbers (hexadecimal) and the unit addresses for the other devices.

Device	Unit address (hexadecimal)
PC's CPU	00
Computer	01 (NSB, SYSMAC LINK Support Board), user application 1
CPU Bus Units	10 + unit number, FE
Group-2 Slaves in SYSMAC BUS/2 Remote I/O Systems	90 + Slave unit number + (Master number x 10)

Note Unit numbers: 0 to F (0 to 15)
 Master numbers: 0 to 3 (0 to 3)
 Group-2 Slave unit numbers: 0 to F (0 to 15) (Communications are not possible with Group-1 Slaves.)

If the unit address has been set to FE, it is possible to designate the SYSMAC NET Link or SYSMAC LINK Unit on the designated node address using the CMND(194) instruction of the message service function. This will free the user from remembering the unit number on each node.

Examples:

SYSMAC NET Link Unit with a unit number of 12:
 $10 + C = 1C$ (hexadecimal)

Group-2 Slave (unit #6) connected to SYSMAC BUS/2 Master #2:
 $90 + 6 + (2 \times 10) = B6$ (hexadecimal)

4-3 Setting Node Addresses

In token bus communications used in the SYSMAC LINK Network, the node addresses make a logical ring around which the token is passed. The logical ring of node addresses takes the place of the actual physical ring used in some other networks. Consequently, proper setting of the node addresses is essential to network operation.

Node address switches determine the node address. The left switch sets the ten's digit; the right switch sets the one's digit. The node address must be between 01 and 62. Each SYSMAC LINK Unit in a Network must have a unique node address.

 **Caution** Always turn the PC's power off before setting or changing node address.

Use a small flat-blade screwdriver to set the node address switches, being careful not to damage them. The following example shows the node address ("NODE NO.") set to 50.

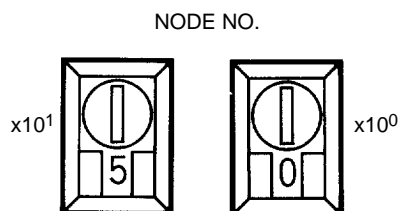

- Note**
1. If the node address set on the Unit is outside of the allowed range (01 to 62), a communications error will occur and the red ERC indicator will light on the Unit.
 2. Each Unit in the network must have a unique node address, so be sure not to use the same address on more than one Unit.
 3. The token is passed from node to node according to node addresses, so the more dispersed the node addresses are, the greater distance the token has to travel. In optical fiber systems, the communications cycle time depends on the distance the token has to travel, so set node addresses in the same order as the nodes' positions in the network if possible.

4-4 Network Address Setting

It is necessary to set a network address on each PC for data exchange between networks. By setting the network address, the local node can exchange data with a destination node even if there is another network between them.

Setting

Use the IBM PC/AT-compatible computer running CVSS to set the network address (refer to the CVSS manuals for details). The network address must be included in the routing table that is stored in the PC's EEPROM (refer to *5-2 Routing Table Setting* for details).

Setting Range

A network can include up to 128 (decimal) addresses. The setting range of the network addresses is thus 0 to 127 (decimal) and network address 0 is the local network address.

4-5 Network Parameters

The operation of the SYSMAC LINK Network is determined by the network parameters. Network parameters are set with Peripheral Devices such as the CVSS, and are automatically backed up within the SYSMAC LINK Unit. The network parameters stored in the polling unit are used in actual system operation; the network parameters in other Units are ignored.

The following table shows the network parameters, their default values, and the ranges within which the parameters can be set by the user. Default values and setting ranges are in decimal.

Network parameter	Default value	Setting range
Communications cycle time	Automatic	5 to 255
Maximum node address	62	2 to 62
Number of polled units per communications cycle	4	1 to 62
Maximum number of frames per communications cycle	10	5 to 255

Communications Cycle Time This parameter sets a timer that fixes the length of the communications cycle to the specified time. The timer operates only when the data link is in operation. Set the communications cycle time when setting the data link table's common link parameters.

When the timer is in operation, the communications cycle time is fixed at the specified value, independent of the number of events that occur. Refer to *5-9 Data Link Characteristics* for the formula needed to calculate the communications cycle time when the data link is set for automatic generation.

Maximum Node Address

This parameter sets the maximum node address that a node can have and still be a part of the network. Nodes with node addresses greater than the maximum node address will not be polled, and therefore will not participate in network communications. This eliminates unnecessary polling of units with node addresses above the maximum, and thus reduces the time required for communications.

Note Set the maximum node address above the highest node address set on the SYSMAC LINK Units currently connected unless you specifically want to exclude one or more nodes from system operation.

Number of Polling Units This parameter determines how many nodes will be polled by the polling unit during a polling cycle. Setting a high number of Units increases the communications cycle time, but reduces the time required to recognize that nodes have been removed from or added to the network.

Maximum Number of Frames This parameter determines how many event transmissions can take place during a token cycle when data links are operating. With the default value of 10 frames, up to 4 event transmissions can be issued.

Event transmissions include instructions such as SEND(192), RECV(193), or CMND(194)), as well as processes such as remote monitoring and remote programming from the CVSS.

Setting a high number of frames increases the communications cycle time, while setting a low number will cause errors because of restrictions on event transmissions when the data link is operating. Increase the number of frames by 3 for each additional event transmission if data links are operating.

Setting Network Parameters Network parameters are set from the CVSS. Set the network parameters after installing the network.



Caution Do not set network parameters while data links are operating.

4-6 Memory Areas

The CPU Bus Unit Area and DM Area of the PC are used to write or read the status of the nodes and the data links of SYSMAC LINK Units. The data from the SYSMAC LINK Unit is written to the input words in these areas. The output words in these areas can be used to control various aspects of Unit operation.

4-6-1 Word Allocation

The memory areas that are used to write or read the data will be allocated according to the unit number.

CPU Bus Unit Area

Each CPU Bus Unit is allocated 25 words from between CIO 1500 and CIO 1899 as follows:

Unit no.	Words
0	1500 to 1524
1	1525 to 1549
2	1550 to 1574
3	1575 to 1599
4	1600 to 1624
5	1625 to 1649
6	1650 to 1674
7	1675 to 1699
8	1700 to 1724
9	1725 to 1749
10	1750 to 1774
11	1775 to 1799
12	1800 to 1824
13	1825 to 1849
14	1850 to 1874
15	1875 to 1899

DM Area

Each CPU Bus Unit is also allocated 100 words from between D02000 and D03599 as follows:

Unit no.	Words
0	D02000 to D02099
1	D02100 to D02199
2	D02200 to D02299
3	D02300 to D02399
4	D02400 to D02499
5	D02500 to D02599
6	D02600 to D02699
7	D02700 to D02799
8	D02800 to D02899
9	D02900 to D02999
10	D03000 to D03099
11	D03100 to D03199
12	D03200 to D03299
13	D03300 to D03399
14	D03400 to D03499
15	D03500 to D03599

4-6-2 Word Application

The application of the words in the CPU Bus Link Area and DM Area that are allocated to SYSMAC LINK Units is described in the following tables.

CPU Bus Unit Area

The first word in the section of the CPU Bus Unit Area allocated to a SYSMAC LINK Unit is used to control data links and communications test. The remaining words are used to access the status of the SYSMAC LINK System as shown in the following table.

I/O*	Word	Bit	Item	Reference	
Output words	+0	0	0: Data link stop 1: Data link set	p. 32	
		1	0: Test stop 1: Test start	p. 132	
Input words	+1	0	1: Network parameter error	p. 148	
		1	1: Data link table error	p. 148	
		2	1: Routing table error	p. 148	
		3	1: Communications unit setting error	p. 10	
		7	1: EEPROM error	p. 148	
		8	1: Node address setting error	p. 24	
		9	1: Node address duplication error	p. 24	
		10	1: Network parameter disagreement error	p. 148	
		11	1: Network controller error	p. 148	
		15	0: No error log record 1: Error log record(s) exists	p. 142	
	+2 to +4	0 to 15	Network participation (1 bit per Unit for each of 62 Units); see information following this table.	p. 29	
	+5	0 to 13	0: Not participating 1: Participating		
	+6	0 to 7	0 to 7	Local node address	p. 24
			8 to 15	Local network address	p. 25
	+7	0 to 7	0 to 7	Node address of Polling Unit	p. 22
			8 to 15	Local unit address	p. 24
	+8 to +22	0 to 15	Data link status on each node (4 bits (PC operating, PC error, communication error, no error) per Unit for each of 62 Units)	p. 44	
	+23	0 to 7		Node address of startup node (for data links)	p. 44
		+24	0	0: Test not being executed 1: Test being executed	p. 133
	11			0: No power supply 1: Power being supplied (CV500-SLK11 only)	p. 9

* I/O classification is in reference to the PC's CPU.

Note The above words will be all cleared when the mode of the PC is changed, or when the PC is turned ON (when set to MONITOR or RUN mode), unless they are set as holding areas. Refer to the CVSS manuals for details.

Network Participation Status

If a node is participating in a network, the bit corresponding to the node address will be ON (1). Node addresses (1 through 62) and their corresponding bits are listed in the following table. Bits 14 and 15 of word +5 are always 0.

Word: 1500 + (25 x unit no.) + 2 to 5

	Bit 15	14	13	12	11	10	9	8	7	6	5	4	3	2	1	0
Word +2	16	15	14	13	12	11	10	9	8	7	6	5	4	3	2	1
+3	32	31	30	29	28	27	26	25	24	23	22	21	20	19	18	17
+4	48	47	46	45	44	43	42	41	40	39	38	37	36	35	34	33
+5	-	-	62	61	60	59	58	57	56	55	54	53	52	51	50	49

The following table shows the actual Network Participation Status Words allocated for each unit number.

Unit no.	Words	Unit no.	Words
0	1502 to 1505	8	1702 to 1705
1	1527 to 1530	9	1727 to 1730
2	1552 to 1555	10	1752 to 1755
3	1577 to 1580	11	1777 to 1780
4	1602 to 1605	12	1802 to 1805
5	1627 to 1630	13	1827 to 1830
6	1652 to 1655	14	1852 to 1855
7	1677 to 1680	15	1877 to 1880

DM Area

The following DM words are used to test SYSMAC LINK communications. It is possible to use these words for a different purpose if no test is being executed.

I/O*	Word	Bit	Item
Output words	+0	0 to 15	Kind of test (set to 0)
	+1	0 to 7	Destination node address
		8 to 15	Destination network address
	+2	0 to 7	No. of transmission bytes
		8 to 15	Response monitor timer setting
+3 to +9	0 to 15	Not used.	
Input words	+10	0 to 15	Kind of test (set to 0)
	+11	0 to 7	Destination node address
		8 to 15	Destination network address
	+12	0 to 7	No. of transmission bytes
		8 to 15	Response monitor timer setting
	+13	0 to 15	No. of tests
	+14	0 to 15	No. of errors
	+15	0 to 15	Test status
	+16	0 to 7	No. of times token timed out
		8 to 15	No. of times that destination node did not participate in network
	+17	0 to 7	No. of times that local node did not participate in network
		8 to 15	No. of times of data disagreement
	+18	0 to 7	No. of times that destination node was busy
		8 to 15	No. of retries
	+19	0 to 7	No. of times that no response was returned
		8 to 15	No. of times allowed number of transmission frames was exceeded
	+20	0 to 7	No. of times that relay node routing failed
		8 to 15	No. of times that local node routing failed
	+21	0 to 7	Main response code (MRES) when routing failed
		8 to 15	Sub-response code (SRES) when routing failed
	+22	0 to 7	Network address where routing failed
		8 to 15	Node address where routing failed
	+23 to +99	0 to 15	Not used.

* I/O classification is in reference to the PC's CPU.

Note Refer to *Section 8-2 Internode Echo Test* for details.

SECTION 5

Data Links

The operation of data links, procedures required to establish data links, and methods of monitoring data link operations are explained in this section.

5-1	Introduction	32
5-2	Creating Data Links	34
5-3	Automatic Generation of Data Link Tables	34
5-4	Manually Generating Data Link Tables	36
5-5	Data Link Table Examples	39
5-5-1	Identical Data Link Tables	39
5-5-2	Different Data Link Tables	40
5-6	Controlling Data Links	43
5-6-1	Software Switches	43
5-6-2	DATA LINK START/HALT Commands	43
5-6-3	CVSS	43
5-7	Data Link Precautions	43
5-8	Data Link Status	44
5-9	Data Link Characteristics	46
5-9-1	Data Link Communications Cycle Time	46
5-9-2	Data Exchange Timing and Data Process Time	48
5-9-3	Transmission Delays	49

5-1 Introduction

Data links can be created between PCs or PCs and computers in the same SYS-MAC LINK Network to exchange data. This data is transferred between interconnected PCs automatically without requiring the use of normal I/O Units.

Words in the CIO and/or DM Areas are set aside as the **data link words** in each PC that is in the data link. Some of the data link words are allocated to the local node and the rest is allocated to other nodes. Data can be written only to the words allocated to the local node. During data link refreshing, data written in the local node is transferred to corresponding words in other nodes' memory areas. The result is that each PC in the data link has a common data link area, the only difference being in the read/write permissions for the various words in it.

Data Link Tables

The data link words in each PC are defined by a **data link table**, which includes both common link parameters, which define the words output by each node in the data link and are thus the same for all nodes, and the refresh parameters, which define the words input by each node and can thus be different for each node.

Data link tables can be generated automatically or manually. Automatic generation is accomplished simply by setting parameters in the Communications Unit Settings from the CVSS. Manual generation is accomplished by setting specific data links from the CVSS.

The following diagram shows the operation of a data link among four nodes in a network. This data link was generated manually.

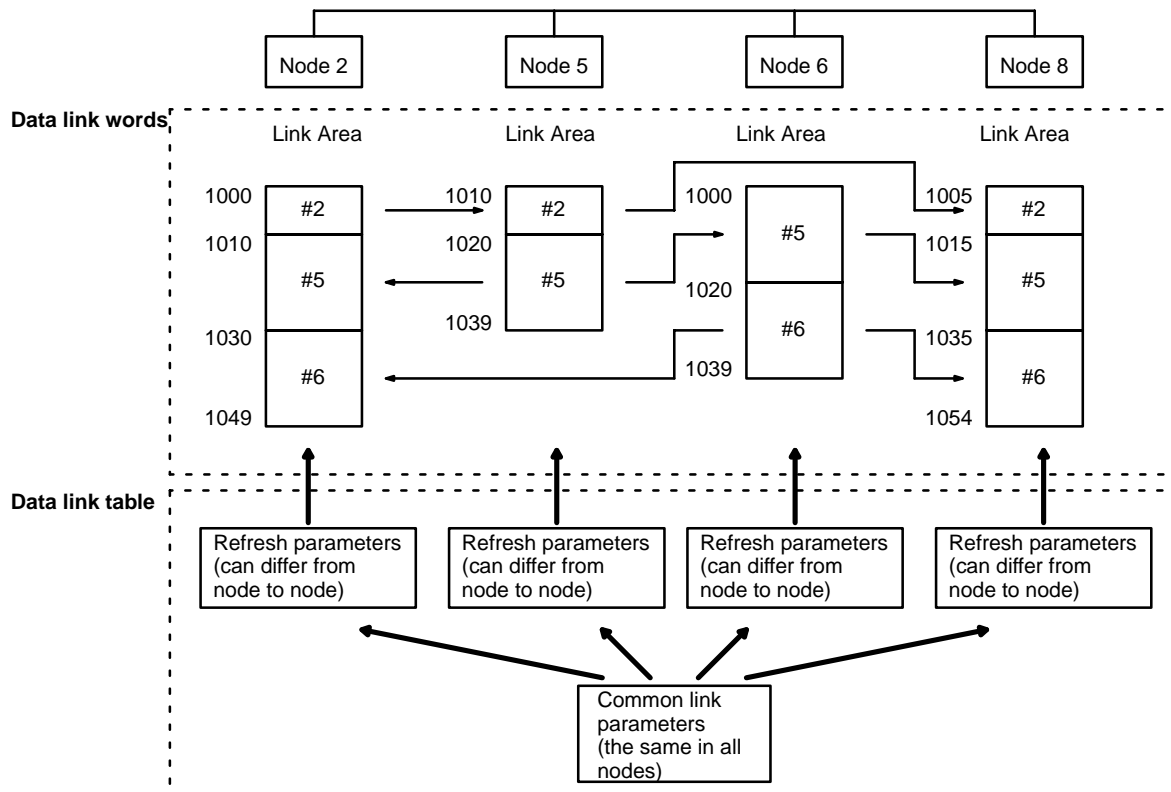

Table Generation

Data link tables can be generated automatically or manually. Data link tables generated automatically are identical in all PCs in the data link, with the words of the data areas listed below divided equally among 2, 4, 8, or 16 nodes. The areas used by each PC are listed in the following table. The number of words allocated to each node depend on the number of nodes linked and is given in the *Data Link Specifications* table later in this section.

Link Area	CIO 1000 to CIO 1063
DM Area	D00000 to D00127

Manual generation provides much greater flexibility in making data links among PCs, but require that you manually input the data link table. Manually generated data links can contain far more words and can use any part of the CIO Area, as shown in the following table.

Area	CV1000, CV2000, or CVM1-CPU11-E	CV500 or CVM1-CPU01-E
CIO Area	CIO 0000 to CIO 2555	
DM Area	D00000 to D24575	D00000 to D08191

Controlling Data Links

Data links can be activated and deactivated by turning ON and OFF bit 00 of the first CPU Bus Link Area word allocated to the SYSMAC LINK Unit in PC memory, i.e., bit 00 of word [1500 +(25 x unit number)].

Data Link Operation

The LNK indicator on the front of the SYSMAC LINK Unit indicates the operational status of the data link, as shown below.

LNK indicator	Data link status
ON	The Unit is part of an active data link.
Flashing	A data link error has occurred.
OFF	The Unit is not part of an active data link.

Data Link Specifications

Basic specifications for data links are provided in the following table.

Item	Description			
No. of data link nodes	62 max., 2 min.			
No. of linked words per node	CIO Area: 254 words max. DM area: 254 words max.			
Max. number of linked words in Network	2,966 words (918 words for any Network with one or more C200H PCs)			
Automatically generated data links	Set in Communications Unit Settings from the CVSS.			
Manually generated data links	Set from the CVSS.			
Status Area (in CPU Bus Link Area)	1500 + (unit no. x 25) + 8 to 23			
	Unit no.	Word	Unit no.	Word
	0	1508 to 1523	8	1708 to 1723
	1	1533 to 1548	9	1733 to 1748
	2	1558 to 1573	10	1758 to 1773
	3	1583 to 1598	11	1783 to 1798
	4	1608 to 1623	12	1808 to 1823
	5	1633 to 1648	13	1833 to 1848
	6	1658 to 1673	14	1858 to 1873
	7	1683 to 1698	15	1883 to 1898
Data link table backup	EEPROM inside PC			

5-2 Creating Data Links

There are two ways to create a data link between PCs, automatically and manually. Both methods require settings to be made from the CVSS. The setting that specifies either automatic or manual generation is also made from the CVSS, as shown below. "Specific" is set for manual creation of the data links. Refer to the CVSS manuals for details.

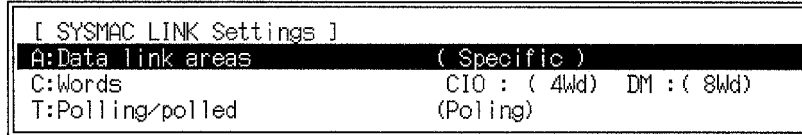

The differences between manual and automatic data link generation are outlined in the following table.

Item	Automatic generation	Manual generation
Number of linked words	All nodes have the same number of linked words.	The number of words read and the number of words written can be set independently for each node.
Linkable words	The following words are automatically used: CIO 1000 to CIO 1063 D00000 to D00127	Any of the words in the CIO and DM Areas can be linked.
Number of linkable nodes	The number of nodes linked and the node addresses are automatically set depending on the number of words set per node.	Data links can be set for any portion or all of the nodes (max.: 62).

5-3 Automatic Generation of Data Link Tables

Settings

To automatically generate data link tables, the SYSMAC LINK Network must be set for automatic generation and the numbers of words per node in each of the Link and DM Areas must be set.

Allocated Words

The words allocated to each node for the various word settings are given in the following table.

Link Area words*	DM Area words*	Words per node			
		CIO: 4 DM: 8	CIO: 8 DM: 16	CIO: 16 DM: 32	CIO: 32 DM: 64
1000 to 1003	D00000 to D00007	Node #1	Node #1	Node #1	Node #1
1004 to 1007	D00008 to D00015	Node #2			
1008 to 1011	D00016 to D00023	Node #3	Node #2	Node #2	Node #2
1012 to 1015	D00024 to D00031	Node #4			
1016 to 1019	D00032 to D00039	Node #5	Node #3	Node #2	Node #2
1020 to 1023	D00040 to D00047	Node #6			
1024 to 1027	D00048 to D00055	Node #7	Node #4	Node #2	Node #2
1028 to 1031	D00056 to D00063	Node #8			
1032 to 1035	D00064 to D00071	Node #9	Node #5	Node #3	Node #2
1036 to 1039	D00072 to D00079	Node #10			
1040 to 1043	D00080 to D00087	Node #11	Node #6	Node #3	Node #2
1044 to 1047	D00088 to D00095	Node #12			
1048 to 1051	D00096 to D00103	Node #13	Node #7	Node #4	Node #2
1052 to 1055	D00104 to D00111	Node #14			
1056 to 1059	D00112 to D00119	Node #15	Node #8	Node #4	Node #2
1060 to 1063	D00120 to D00127	Node #16			

Note *When combining CV-series PCs in data links with C-series PCs, LR 00 to LR 63 in C-series PCs correspond to CIO 1000 to CIO 1063 in CV-series PCs and DM 0000 to DM 0127 correspond to D00000 to D00127.

Data Flow

This example shows data flow resulting from automatic generation with four PCs exchanging 16 Link Area words each. The DM Area words are not shown. Shading indicates the words written and transmitted by each PC; non-shaded words are those received from other PCs.

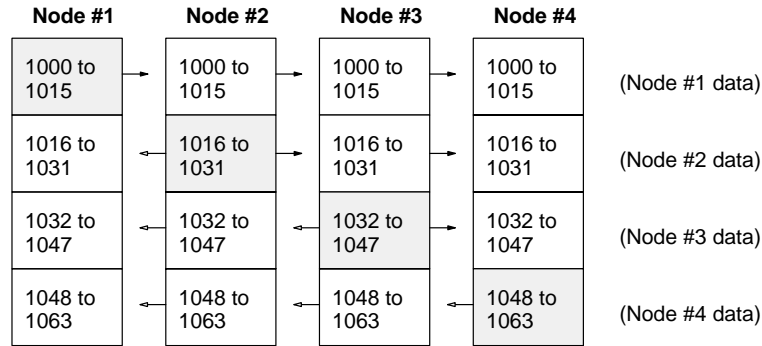

Data Link Area Refresh

Data links are refreshed for all nodes between the lowest-numbered and the highest-numbered node designated to participate in the data link. Link words automatically allocated to nodes assigned numbers lower than the lowest-number participating node or higher than the highest-number participating node can be used as work words. Words allocated to a node address between the lowest and highest-numbered nodes cannot be used as work words even if there isn't a node with that node address.

The example below shows a configuration consisting of four nodes that have been set to link 8 words per node in the CIO Area only. Of the eight possible nodes, only nodes #2, #4, #5, and #6 are actually in the System. Words normally allocated to nodes #1, #7, and #8 can therefore be used as work words, but words normally allocated to node #3 cannot, because they are refreshed by the System.

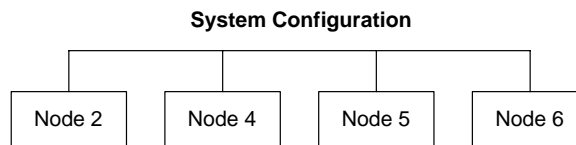

Refreshing for the above System will be as shown below:

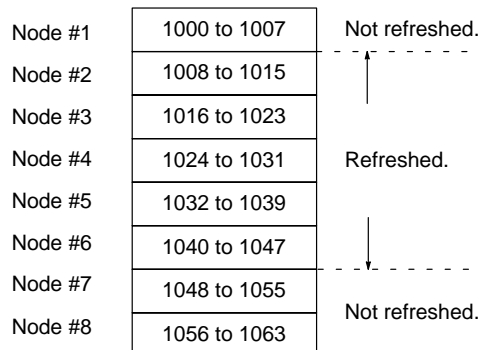

5-4 Manually Generating Data Link Tables

The CVSS is required to specify data link tables manually. Generating data link tables manually allows considerable flexibility in data links. Each PC can be set up independently to link to the desired PCs only.

The structure and operation of data link tables are described in this manual. Refer to the CVSS manuals for specific procedures and displays used in setting the tables.

Data link tables contain two types of information: common link parameters, which are the same in all nodes and control the overall structure of the data links, and refresh parameters, which are set independently for each node to determine which links are to be established for that node.

Common Link Parameters

Common link parameters determine the communications cycle time of the data link, which areas will be enabled for data links, and how many CIO and DM Area words will be transmitted from each PC. The same common link parameters must be set in all nodes that are to be part of a data link in the same network. The display used to input the common link parameters is shown following the table.

Parameter	Description
Communications cycle time	The data link communications time between 5 and 255 ms. The communications cycle time will be self-generating if not specified.
No. of nodes in data link and their node addresses	This information is set automatically when the No. of CIO Area words and No. of DM words parameters (see below) are entered.
No. of CIO Area words* transmitted by each node	The number of CIO Area words transmitted by each node 0 to 254: 0 to 254 words -: Not part of data link 0: Can read CIO Area words from other nodes only.
No. of DM words* transmitted by each node	The number of DM words transmitted by each node 0 to 254: 0 to 254 words -: Not part of data link 0: Can read DM words from other nodes only.

Note *When combining CV-series PCs in data links with C-series PCs, LR 00 to LR 63 in the C-series PCs correspond to CIO 1000 to CIO 1063 in the CV-series PCs and DM 0000 to DM 0127 correspond to D00000 to D00127.

CVSS

Com cyc time[---ms]

Node	I/O #	DM #	Node	I/O #	DM #	Node	I/O #	DM #	Node	I/O #	DM #
01	-	-	17	-	-	33	-	-	49	-	-
02	-	-	18	-	-	34	-	-	50	-	-
03	-	-	19	-	-	35	-	-	51	-	-
04	-	-	20	-	-	36	-	-	52	-	-
05	-	-	21	-	-	37	-	-	53	-	-
06	-	-	22	-	-	38	-	-	54	-	-
07	-	-	23	-	-	39	-	-	55	-	-
08	-	-	24	-	-	40	-	-	56	-	-
09	-	-	25	-	-	41	-	-	57	-	-
10	-	-	26	-	-	42	-	-	58	-	-
11	-	-	27	-	-	43	-	-	59	-	-
12	-	-	28	-	-	44	-	-	60	-	-
13	-	-	29	-	-	45	-	-	61	-	-
14	-	-	30	-	-	46	-	-	62	-	-
15	-	-	31	-	-	47	-	-			
16	-	-	32	-	-	48	-	-			

Maximum Linked Words

The number of linked words that can be transmitted within one Network is limited. This limit determines the total number of CIO and DM words which can be set for all nodes in the common link parameters. The limit for the C200H applies to all Networks that include one or more C200H PCs.

PC	Maximum no. of linked words
C200H	918
CV-series PCs	2,966

Refresh Parameters

Refresh parameters are set for each node to determine the words whose contents will be read by each node. Enter the link words in the CIO and DM Areas for the local node as well as all of the nodes to which the local node will be linked.

Parameter	Description
PC model	Enter the model number of the PC at the local node (the node for which the refresh parameters are being set).
Node address	Enter the node addresses of the local node and nodes to which the local node will be linked. Nodes not set (set to "-") in the Common Link Parameters cannot be specified here.
Number of refreshed nodes	Automatically incremented as refresh parameters are set for each node, i.e., indicates the number of nodes for which refresh parameters have been set.
Beginning status word	Sets the beginning word of the region in memory that will contain the Data Link Status Flags for the nodes in the data link. Refer to 5-8 Data Link Status for details.
Beginning CIO word (I/O)	Sets the first word of the data link area in the CIO Area.
Beginning DM word (DM)	Sets the first word of the data link area in the DM area.

Note Refer to the CVSS manuals for details on editing and setting data link tables.

CVSS

Node[01] PC[CV-ser] refreshWd [0000] [D00000] status Wd [D00200]

#	Node	I/O	DM	#	Node	I/O	DM	#	Node	I/O	DM	#	Node	I/O	DM
1				17				33				49			
2				18				34				50			
3				19				35				51			
4				20				36				52			
5				21				37				53			
6				22				38				54			
7				23				39				55			
8				24				40				56			
9				25				41				57			
10				26				42				58			
11				27				43				59			
12				28				44				60			
13				29				45				61			
14				30				46				62			
15				31				47							
16				32				48							

Table Backup

Data link tables are automatically stored up in the EEPROM of the PC-s CPU of the Unit involved if so set from the CVSS. It is advisable, however, for common link and refresh parameters to be backed up for safety. For details, refer to the CVSS manuals.

Note Data link tables are set in the EEPROM of the CPU. If the CPU is replaced or if the unit or node address of a SYSMAC LINK Unit is altered, it is necessary to set data link tables again.

Refreshing Data Link Areas (Manual Setting)

When manual setting has been selected, data link area will be refreshed from the first node through last node that can exchange data with one another in the data link area as specified in the refresh parameters. If the manual setting and the refresh parameters of node 3 are as follows, an 8-node data link area will be created, but nodes 1, 2, and 5 will not be refreshed because they do not actually exist. The user can use the words allocated to these nodes for any desired purpose.

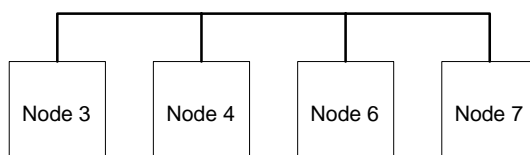

Disp dat link tbl SYSMAC LINK

Node[01] PC[CU-ser] refreshWd[0000] [D00000] status Wd[D00200]

#	Node	I/O	DM	#	Node	I/O	DM	#	Node	I/O	DM	#	Node	I/O	DM
1	01	1	1	17				33				49			
2	02	1	1	18				34				50			
3				19				35				51			
4				20				36				52			
5				21				37				53			
6				22				38				54			
7				23				39				55			
8				24				40				56			
9				25				41				57			
10				26				42				58			
11				27				43				59			
12				28				44				60			
13				29				45				61			
14				30				46				62			
15				31				47							
16				32				48							

Node[01] refreshWd[0000] [D00000]

1 node 2 comm 3 4 5 6 7 8 9 0

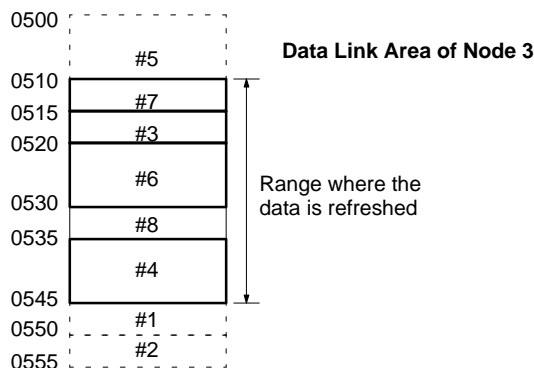

The data link area of node 3 is shown in the above illustration. Node 7 is the first node that exchanges data with other nodes in the data link and node 4 is the last node. In this case, 5 nodes including node 8 (words between 0510 and 0544) will be refreshed. If data has ever been received for node 8, the refresh data will remain the same unless it becomes active in the link again. If data has never been received for node 8, it will be refreshed with all zeros.

5-5 Data Link Table Examples

Three examples of manually generated data links are presented in this section. In the first, identical data link tables are set up in all nodes. In the second, a different data link table is set up in each node. In the third, data links are set up in two separate groups of PCs.

5-5-1 Identical Data Link Tables

To generate the same data link tables in all PCs in the Network, set the same refresh parameters for each node. Although refresh parameters must be set for each node, the copy function in the CVSS can copy a node's refresh parameters and greatly simplify the generation of the data link.

The data flow for an example configuration is shown below.

Data Flow

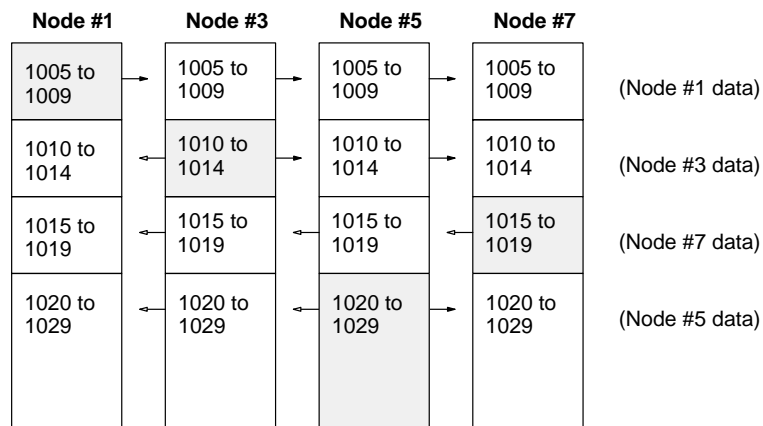

5-5-2 Different Data Link Tables

In this example, the refresh parameters differ from node to node, so the data link tables will also differ from node to node. There are four nodes in the network (2, 5, 6, and 8), but some nodes will not receive data from others. The settings for the common link and refresh parameters are shown after the data flow.

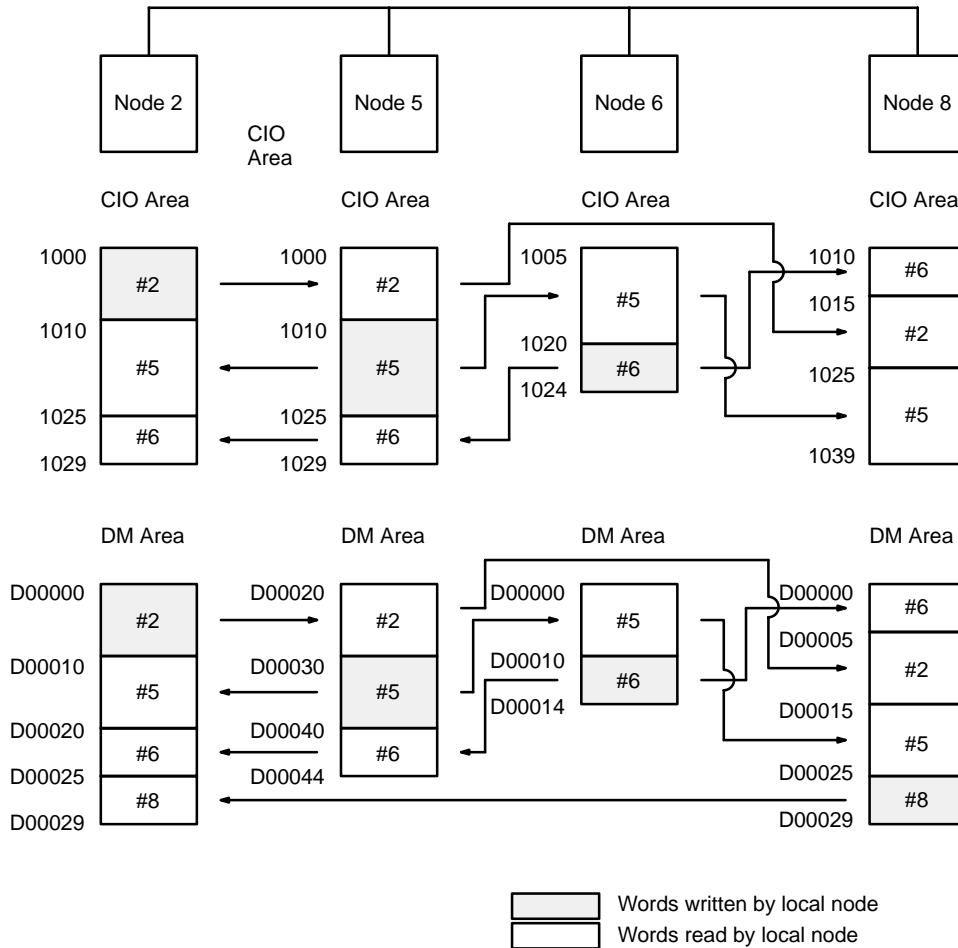

Common Link Parameters

These parameters are set from the CVSS, and need to be set only once for a SYSMAC LINK Network. Enter the communications cycle time and the number of DM and CIO Area link words for each node in the data link, as shown below. (Setting the number of CIO Area link words to zero for node 8 means that node 8 will be able to receive but not send data.)

With manual data link table generation, the number of link words sent from each node can be set in 1-word increments.

Com cyc time[---ms]

Node	I/O #	DM #	Node	I/O #	DM #	Node	I/O #	DM #	Node	I/O #	DM #
01	-	-	17	-	-	33	-	-	49	-	-
02	10	10	18	-	-	34	-	-	50	-	-
03	-	-	19	-	-	35	-	-	51	-	-
04	-	-	20	-	-	36	-	-	52	-	-
05	15	10	21	-	-	37	-	-	53	-	-
06	5	5	22	-	-	38	-	-	54	-	-
07	-	-	23	-	-	39	-	-	55	-	-
08	0	5	24	-	-	40	-	-	56	-	-
09	-	-	25	-	-	41	-	-	57	-	-
10	-	-	26	-	-	42	-	-	58	-	-
11	-	-	27	-	-	43	-	-	59	-	-
12	-	-	28	-	-	44	-	-	60	-	-
13	-	-	29	-	-	45	-	-	61	-	-
14	-	-	30	-	-	46	-	-	62	-	-
15	-	-	31	-	-	47	-	-			
16	-	-	32	-	-	48	-	-			

Refresh Parameters

These parameters are also set from the CVSS, and need to be set separately for each node in the data link. Enter the PC model, beginning CIO and DM words, and beginning status word (for C-series PCs only), then set the number of CIO and DM link words for the local node and each node to which the local node will be linked.

The number of CIO and DM words set for each node in the common link parameters will be allocated to nodes automatically in the order that they have been entered into the refresh parameters table. Link word allocation starts at the beginning CIO and DM words. The order of nodes in the refresh parameters table can be changed freely.

Node #2

In node 2, the data link area will be allocated to nodes 2, 5, 6, and 8 in that order, so the node 2 refresh parameters are set as shown below.

Node[02] PC[CV-ser] refreshWd[1000] [D00000] status Wd[D00000]

#	Node	I/O	DM	#	Node	I/O	DM	#	Node	I/O	DM	#	Node	I/O	DM
1	02	10	10	17				33				49			
2	05	15	10	18				34				50			
3	06	5	5	19				35				51			
4	08	0	5	20				36				52			
5				21				37				53			
6				22				38				54			
7				23				39				55			
8				24				40				56			
9				25				41				57			
10				26				42				58			
11				27				43				59			
12				28				44				60			
13				29				45				61			
14				30				46				62			
15				31				47							
16				32				48							

Node #5

In node 5, the data link area will be allocated to nodes 2, 5, and 6 in that order, so the node 5 refresh parameters are set as shown below. DM Area allocation is set to begin at DM 0020. (Node 8 data will not be received at node 5, so node 8 is not entered in the table.)

Node[05] PC[CU-ser] refreshWd[1000] [D00020] status Wd[D00200]

#	Node	I/O	DM	#	Node	I/O	DM	#	Node	I/O	DM	#	Node	I/O	DM
1	02	10	10	17				33				49			
2	05	15	10	18				34				50			
3	06	5	5	19				35				51			
4				20				36				52			
5				21				37				53			
6				22				38				54			
7				23				39				55			
8				24				40				56			
9				25				41				57			
10				26				42				58			
11				27				43				59			
12				28				44				60			
13				29				45				61			
14				30				46				62			
15				31				47							
16				32				48							

Node #6

In node 6, the data link area will be allocated to nodes 5 and 6 in that order, so the node 6 refresh parameters are set as shown below. CIO Area allocation is set to begin at CIO 1005. (Data from nodes 2 and 8 will not be received at node 6, so they are not entered in the table.)

Node[06] PC[CU-ser] refreshWd[1005] [D00000] status Wd[D00200]

#	Node	I/O	DM	#	Node	I/O	DM	#	Node	I/O	DM	#	Node	I/O	DM
1	05	15	10	17				33				49			
2	06	5	5	18				34				50			
3				19				35				51			
4				20				36				52			
5				21				37				53			
6				22				38				54			
7				23				39				55			
8				24				40				56			
9				25				41				57			
10				26				42				58			
11				27				43				59			
12				28				44				60			
13				29				45				61			
14				30				46				62			
15				31				47							
16				32				48							

Node #8

In node 8, the data link area will be allocated to nodes 6, 2, 5, and 8 in that order, so the node 5 refresh parameters are set as shown below. CIO Area allocation is set to begin at CIO 1010.

Node[08] PC[CU-ser] refreshWd[1010] [D00000] status Wd[D00200]

#	Node	I/O	DM	#	Node	I/O	DM	#	Node	I/O	DM	#	Node	I/O	DM
1	02	10	10	17				33				49			
2	05	15	10	18				34				50			
3	06	5	5	19				35				51			
4	08	0	5	20				36				52			
5				21				37				53			
6				22				38				54			
7				23				39				55			
8				24				40				56			
9				25				41				57			
10				26				42				58			
11				27				43				59			
12				28				44				60			
13				29				45				61			
14				30				46				62			
15				31				47							
16				32				48							

5-6 Controlling Data Links

Data links can be started and stopped in any of three ways: using the software switches in the first CPU Bus Unit Area word allocated to the Unit, using the CMND(194) instruction from network PCs or the DATA LINK START/HALT commands from network computers, or using CVSS operations.

5-6-1 Software Switches

Data links can be started by turning ON bit 00 of the first CPU Bus Unit Area word (1500 + (25 x unit number)) allocated to the SYSMAC LINK Unit designated as the start-up node. Data links can be stopped by turning OFF this bit. The bit can be manipulated either from the CVSS or from the PC's program. Refer to the CVSS manuals for details.

Note The CPU Bus Unit Area is not a holding area by default and it's contents will be cleared when the PC is restarted or the PC's operating mode is changed. If status in the CPU Bus Unit Area is to be maintained under these conditions, all or part of it can be set as a holding area. Refer to the CVSS manuals for details.

5-6-2 DATA LINK START/HALT Commands

Data link operations can be initiated by issuing a DATA LINK START command from a CV-series PC or host computer to the start-up node or by executing the CMND(194) instruction to start the data link.

Data link operation can be stopped by issuing a DATA LINK HALT command from a CV-series PC or host computer to the start-up node or by executing the CMND(194) instruction to stop the data link.

Refer to 7-9-1 *DATA LINK START* and 7-9-2 *DATA LINK HALT* or to the *CV-series PC Operation Manual: Ladder Diagrams* for details.

5-6-3 CVSS

The data link can be activated or halted from the CVSS. Refer to CVSS manuals for details.

5-7 Data Link Precautions

Be sure to consider the precautions listed below when activating a data link or adding a node to an existing data link.

Set-up and Activation

Be sure to consider the precautions listed below when setting up and activating a data link.

- 1, 2, 3...
 1. Refresh parameters must be set for each node in the data link when manually generating data link tables. When a data link is started in a node that doesn't have a data link table, a data link table error will occur and the LNK indicator on that node will flash.
Refresh parameters must be set for all nodes that are included in the common link parameters in the start-up node.
 2. When data links are automatically generated, the node addresses of the all nodes in the data link must be in the range resulting from the Communication Unit Settings.
For example, if the settings divide the data link area among nodes number 1 to 4 (16 CIO words and 32 DM words), node 5 cannot participate in the data link.
 3. With manual generation of data link tables, the node address of the local node must be included in the local refresh parameters.

4. If the beginning CIO or DM word in the refresh parameters is set too large, the CIO or DM Area will be exceeded during automatic allocation of link words.

If the data area is exceeded in the start-up node, the LNK indicator on the start-up node will flash and the data link will not operate. If the data area is exceeded in another node, the LNK indicator on that node will flash and it will not participate in the data link.

5. The CPU Bus Unit Area is not a holding area by default and it's contents will be cleared when the PC is restarted or the PC's operating mode is changed. If status in the CPU Bus Unit Area is to be maintained under these conditions, all or part of it can be set as a holding area. Refer to the CVSS manuals for details.

Adding Nodes

Be sure to consider the precautions listed below when adding a node to an operating data link.

- 1, 2, 3...
 1. The node address of the node being added must be in the common link parameters of the operating data link.
 2. If the start-up node of the operating data link is using manual generation of data link tables, the node being added must have its refresh parameters set. If automatic generation of data link tables is being used, the refresh parameters are not necessary, but the node being added must be within the range resulting from Communication Unit Settings if it is to participate in the data links.
 3. The common link parameters of the node being added must match those of the operating data link or it cannot be a part of data link operations.

5-8 Data Link Status

For CV-series PCs, data link status is output to consecutive words starting from the 8th word allocated to the Unit in the CPU Bus Unit Area, i.e., from [CIO 1500 + (25 x unit number) + 8] to [CIO 1500 + (25 x unit number) + 23]. Data status is only available for the nodes designated in the refresh parameters, i.e., the nodes from which link data is being received. In the following table, m represents 1500 + (25 x unit number).

The numbers in the table represent the order in which nodes are set in the refresh parameters, e.g., if node 08 is set first in the refresh parameters, it's status will be contained in bits 00 to 03 of m+8. If automatic generation of data link tables is used, the numbers will be the same as the node addresses.

Word	Bits 00 to 03	Bits 04 to 07	Bits 08 to 11	Bits 12 to 15
m+8	Link no. 1	Link no. 2	Link no. 3	Link no. 4
m+9	Link no. 5	Link no. 6	Link no. 7	Link no. 8
m+10	Link no. 9	Link no. 10	Link no. 11	Link no. 12
m+11	Link no. 13	Link no. 14	Link no. 15	Link no. 16
m+12	Link no. 17	Link no. 18	Link no. 19	Link no. 20
m+13	Link no. 21	Link no. 22	Link no. 23	Link no. 24
m+14	Link no. 25	Link no. 26	Link no. 27	Link no. 28
m+15	Link no. 29	Link no. 30	Link no. 31	Link no. 32
m+16	Link no. 33	Link no. 34	Link no. 35	Link no. 36
m+17	Link no. 37	Link no. 38	Link no. 39	Link no. 40
m+18	Link no. 41	Link no. 42	Link no. 43	Link no. 44
m+19	Link no. 45	Link no. 46	Link no. 47	Link no. 48
m+20	Link no. 49	Link no. 50	Link no. 51	Link no. 52
m+21	Link no. 53	Link no. 54	Link no. 55	Link no. 56
m+22	Link no. 57	Link no. 58	Link no. 59	Link no. 60
m+23	Link no. 61	Link no. 62	Bits 08 to 13: address of starting node (01 to 3E hex) Bit 15: Local Data Link Active Flag (ON: data link active; OFF: data link inactive)	

The status of the bits allocated to each node is as follows:

- Bit 00, 04, 08, or 12: PC RUN Flag
- Bit 01, 05, 09, or 13: PC Error Flag
- Bit 02, 06, 10, or 14: Communications Error Flag
- Bit 03, 07, 11, or 15: Data Link Active Flag.

The actual words allocated for each node address for data link status are shown in the following table.

Unit no.	Words	Unit no.	Words
0	1508 to 1523	8	1708 to 1723
1	1533 to 1548	9	1733 to 1748
2	1558 to 1573	10	1758 to 1773
3	1583 to 1598	11	1783 to 1798
4	1608 to 1623	12	1808 to 1823
5	1633 to 1648	13	1833 to 1848
6	1658 to 1673	14	1858 to 1873
7	1683 to 1698	15	1883 to 1898

5-9 Data Link Characteristics

5-9-1 Data Link Communications Cycle Time

Data link servicing is given priority in SYSMAC LINK Systems. The communications time for a data link can thus be maintained as a constant, regardless of whether or not SEND(192)/RECV(193)/CMND(194) are used. Fixing the data link communications time at a constant value fixes the data link I/O response time as well.

The communications cycle time can be set either automatically (the default) or controlled externally.

Automatic Generation

When data link tables have been generated automatically, the communications time will be as follows for systems using coaxial cable:

No. of nodes	Data link area		
	CIO and DM Areas	CIO Area only	DM Area only
2	19 ms	17 ms	18 ms
4	19 ms	17 ms	18 ms
8	19 ms	18 ms	18 ms
16	19 ms	18 ms	19 ms

The communications time will be as follows for systems using optical fiber cable.

No. of nodes	Data link area		
	CIO and DM Areas	CIO Area only	DM Area only
2	21 ms	20 ms	21 ms
4	22 ms	20 ms	21 ms
8	22 ms	21 ms	21 ms
16	22 ms	21 ms	22 ms

Manual Generation

When data link tables have been generated manually, the communications cycle time can be set to a constant value or generated automatically.

The communications cycle time can be set as a constant from 5 to 255 ms in increments of 1 ms via the CVSS to eliminate variations caused by noise or other factors. When the communications cycle time is not set as a constant, it will be generated automatically according to the equations below. Round the result of the calculation to the nearest millisecond.

Communications cycle time (coaxial cable systems) =
 Maximum node address × 0.085 ms + maximum number of frames × 0.654 ms
 + number of polled units × 0.75 ms + number of Link Units × 0.056 ms
 + total number of words × 0.01 ms + 1.322 ms

Communications cycle time (optical fiber cable systems) =
 maximum node address × 0.1115 ms + maximum number of frames × 0.77 ms
 + number of polled units × 0.75 ms + number of Link Units × 0.056 ms
 + total number of words × 0.010 ms + 1.322 ms

Note The present and maximum values of the communications cycle time can be monitored from the CVSS.

Example Calculations

The examples below calculate the communications cycle time for both coaxial and optical fiber cable with the following characteristics:

Maximum node address: 62
 Maximum number of frames: 10
 Number of polled units: 4
 Number of Link Units 32
 Total number of words 2,000

Communications cycle time (coaxial cable systems) =
 $62 \times 0.085 \text{ ms} + 10 \times 0.654 \text{ ms} + 4 \times 0.75 \text{ ms} + 32 \times 0.056 \text{ ms} + 2000 \times 0.01 \text{ ms} + 1.322 \text{ ms}$
 = 37.924 ms (38 ms after rounding)

Communications cycle time (optical fiber cable systems) =
 $62 \times 0.1115 \text{ ms} + 10 \times 0.77 \text{ ms} + 4 \times 0.75 \text{ ms} + 32 \times 0.056 \text{ ms} + 2000 \times 0.01 \text{ ms} + 1.322 \text{ ms}$
 = 40.727 ms (41 ms after rounding)

 **Caution** Data links might not operate correctly if the communications cycle time is set to a value shorter than that generated automatically by the system.

Changing the Communications Cycle Time

When the communications cycle time is generated automatically, it can be changed by changing the other network parameters on the CVSS. The default values and setting ranges of the other network parameters are shown in the table below.

Network parameter	Default value	Setting range
Maximum node address	62	2 to 62
Number of polled units	4	1 to 62
Maximum number of frames	10	5 to 255

Use the following formulas to calculate the change in the communications cycle time that results from a change in other network parameters. A positive result indicates the communications cycle time has been decreased and a negative result indicates it has been increased. Round the result of the calculation to the nearest millisecond.

Change of the communications cycle time (coaxial cable systems) =
 $(\text{old maximum node address} - \text{new maximum}) \times 0.085 \mu\text{s}$
 $+ (\text{old maximum number of frames} - \text{new maximum}) \times 0.654 \mu\text{s}$
 $+ (\text{old number of polled units} - \text{new number}) \times 0.750 \mu\text{s}$

Change of the communications cycle time (optical fiber cable systems) =
 $(\text{old maximum node address} - \text{new maximum}) \times 0.1115 \mu\text{s}$
 $+ (\text{old maximum number of frames} - \text{new maximum}) \times 0.77 \mu\text{s}$
 $+ (\text{old number of polled units} - \text{new number}) \times 0.75 \mu\text{s}$

Example Calculations

The examples below calculate the change of the communications cycle time for both coaxial and optical fiber cable when the other network parameters are changed as shown below:

Maximum node address: Changed from 62 to 16

Maximum number of frames: .. Changed from 10 to 13

Number of polled units: Changed from 4 to 5

Change of the communications cycle time (coaxial cable systems) =
 $(62 - 16) \times 0.085 \text{ ms} + (10 - 13) \times 0.654 \text{ ms} + (4 - 5) \times 0.75 \text{ ms} =$
 1.198 ms (1 ms after rounding)

Change of the communications cycle time (optical fiber cable systems) =
 $(62 - 16) \times 0.1115 \text{ ms} + (10 - 13) \times 0.77 \text{ ms} + (4 - 5) \times 0.75 \text{ ms} =$
 2.069 ms (2 ms after rounding)

- Note**
1. If the maximum node address is set to a value less than the node address of any nodes in the data link, those nodes will no longer be part of the data links.
 2. If the maximum number of frames is set too low, errors might occur during the execution of operations such as SEND(192), RECV(193), and CMND(194) instructions, internode echo tests, and remote monitoring.

- Lowering the number of polled units will increase the delay between resetting a Unit or turning on its PC's power and its entrance into the network.

5-9-2 Data Exchange Timing and Data Process Time

The data exchange timing between the SYSMAC LINK Unit and PC varies with the CPU execution mode of the PC, which must be set in the PC Setup from the CVSS as follows:

Non-synchronous Operation The PC's memory and SYSMAC LINK Unit's buffer are used for data transmission (i.e., the data received by the PC or SYSMAC LINK Unit are kept in the memory or buffer temporarily).

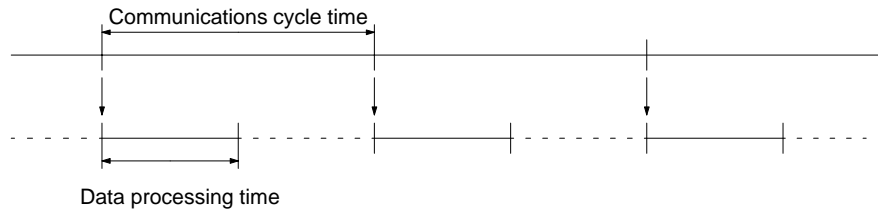

To calculate the approximate time required for data processing, refer to the table below. Data processing time includes the time required for the data exchange. The following graph shows the relationship between data processing time and the number of data link nodes.

Data being exchanged	Data processing time (unit: ms)
When the CIO Area and DM Area are used for data links	Total area words x 0.00254 + no. of link nodes x 0.472 + 6
When only the CIO Area or DM Area is used for data links	Total area words x 0.00215 + no. of link nodes x 0.424 + 6

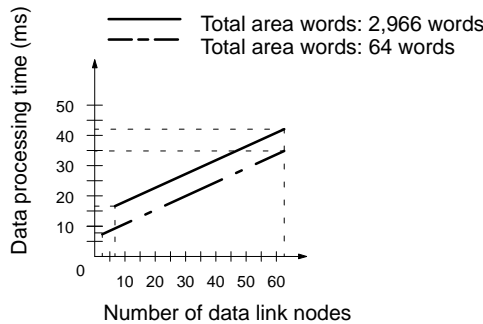

- Note**
- Use the above formulas only if only one SYSMAC LINK Unit is mounted on the PC. If the PC has other CPU Bus Units, add the results of the following formula:
 Refreshing time + 1.5 ms x No. of other CPU Bus Units
 - The execution of some items takes precedence over data link area refreshing. For example, while the SEND(192), RECV(193), or FAL(006) instruction is being executed, data link area refreshing will take longer because the execution of these instructions takes precedence.

Synchronous Operation The PC's memory and SYSMAC LINK Unit's buffer are used for data transmission in synchronization with the peripheral service timing signal.

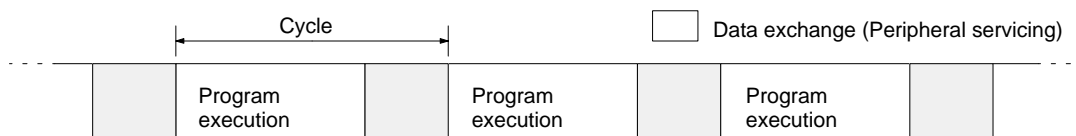

Note Data link communication between nodes or a data exchange between PCs are not synchronized with the peripheral servicing timing signal.

5-9-3 Transmission Delays

The transmission delay is the time required to transmit data from a PC and receive it by a destination PC. Transmission delays vary with the CPU execution mode of the PC as follows:

Non-synchronous Operation The minimum data link transmission delay is shown in the following timing chart.

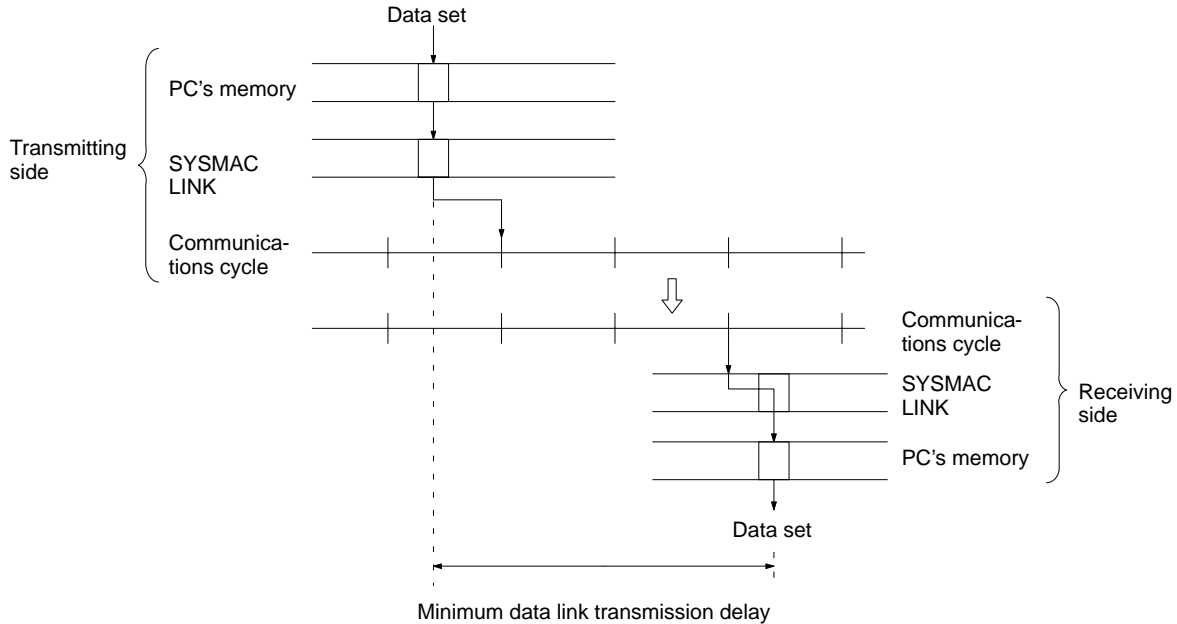

Calculate the minimum data link transmission delay as follows:

$$\text{Minimum data link transmission delay (ms)} = \text{Communications cycle time} \times 3$$

Note When the data processing time is larger than communications cycle time, apply the following formula:

$$\text{Minimum data link transmission delay (ms)} = \text{Communications cycle time} \times 4$$

The maximum data link transmission delay is shown in the following timing chart.

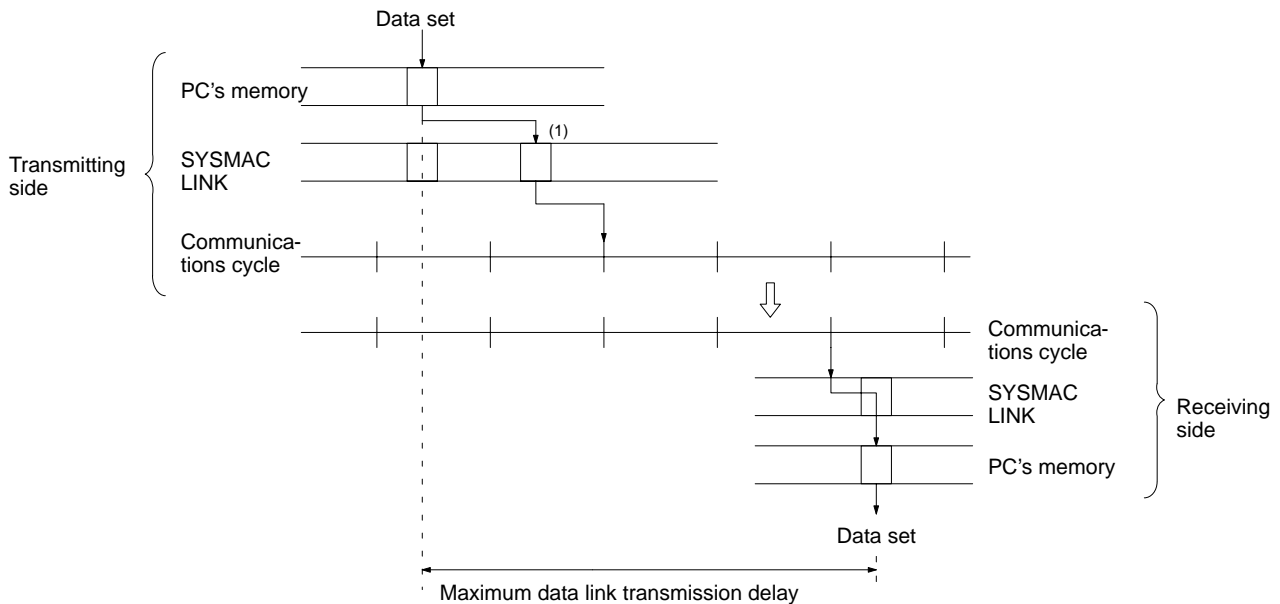

(1) The delay occurs because the command is executed immediately after a previous data exchange. A delay of approximately one communications cycle is caused by the processing of the command, and until then the next data exchange is not available. Calculate the maximum data link transmission delay as follows:

$$\text{Maximum data link transmission delay (ms)} = \text{Communications cycle time} \times 4 + 6$$

Note When data processing time is larger than communications cycle time, apply the following formula:

$$\text{Minimum data link transmission delay (ms)} = \text{Communications cycle time} \times 7 + 6$$

Calculation Example

Conditions

Transmission path: Coaxial cable

No. of link nodes: 8 nodes

No. of area words: 8 words/node

Network parameters: Maximum number of nodes: 8; No. of polled nodes: 4; No. of frames transmitter per cycle: 10

Transmitting communications cycle: 20 ms

Receiving communications cycle: 50 ms

$$\text{Communications cycle time (automatic generation)} = 8 \times 0.085 + 10 \times 0.654 + 4 \times 0.75 + 8 \times 0.056 + (8 \times 8) \times 0.01 + 1.322 = 12.63 \text{ (13 ms)}$$

$$\text{Data processing time} = (8 \times 8) \times 0.00215 + 8 \times 0.424 + 6 = 9.52 \text{ ms}$$

$$\text{Minimum data link transmission delay} = 13 \times 3 = 39 \text{ ms}$$

$$\text{Maximum data link transmission delay} = 13 \times 4 + 6 = 58 \text{ ms}$$

Synchronization Operation with Communications Cycle Time Smaller than PC's Cycle Time

Minimum data link transmission delay is shown in the following timing chart.

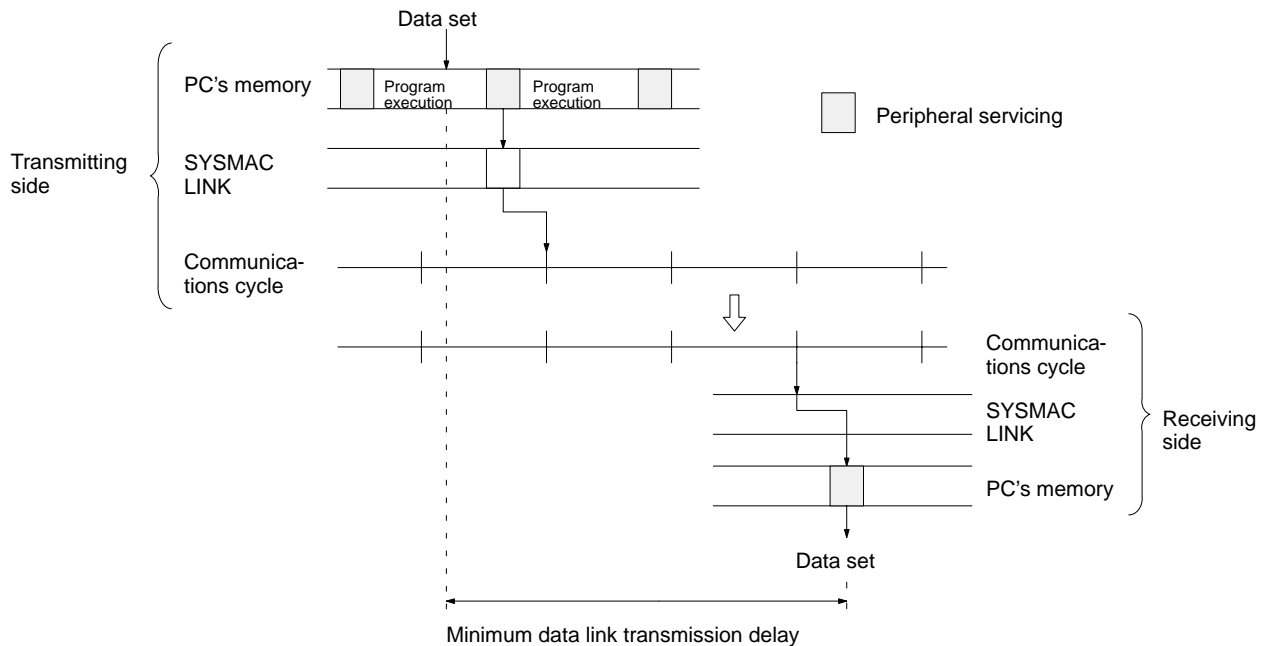

Calculate the minimum data link transmission delay as follows:

$$\text{Minimum data link transmission delay (ms)} = \text{Communications cycle time} \times 3$$

Note When data processing time is larger than communications cycle time, apply the following formula:

$$\text{Minimum data link transmission delay (ms)} = \text{Communications cycle time} \times 4$$

Calculate the maximum data link transmission delay as follows:

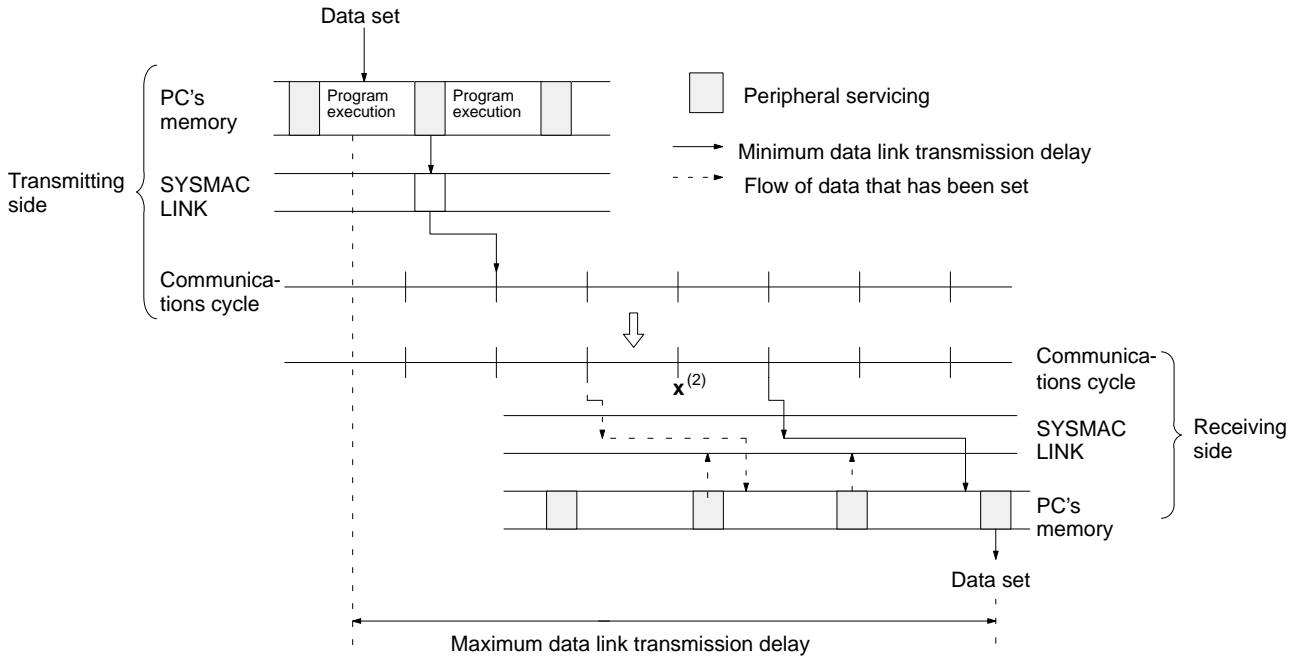

- (1) The delay occurs because the data exchange misses the communications cycle. A delay of approximately one communications cycle is caused by the processing of the command, and until then the next data exchange is not available.
- (2) The previous data exchange has not been completed and thus data retrieval is disabled, and the processing of the command delayed.

Maximum data link transmission delay is calculated as follows:

$$\text{Maximum data link transmission delay (ms)} = \text{Transmitting PC's Cycle Time (see note 1)} + \text{Communications cycle time} \times 2 + \text{Receiving PC's cycle time} \times 3 \text{ (see note 2)} + 6$$

- Note**
- 1. When data processing time is larger than the transmitting PC's cycle time, multiply the transmitting PC's cycle time by 2 in the above formula.
 - 2. When data processing time is larger than the receiving PC's cycle time, multiply the receiving PC's cycle time by 5 in the above formula.

Calculation Example

Conditions

- Transmission path: Coaxial cable
- No. of link nodes: 8 nodes
- No. of area words: 4 words, DM 4 words/node
- Network parameters: Maximum node address: 62; Number of polled units: 4;
- Number of frames transmitted per cycle: 10
- Transmitting PC's cycle time: 30 ms
- Receiving PC's cycle time: 30 ms

$$\text{Communications cycle time (automatic generation)} = 62 \times 0.085 + 10 \times 0.654 + 4 \times 0.75 + 8 \times 0.056 + \{(4 + 4) \times 8\} \times 0.01 + 1.322 = 17.22 \text{ (18 ms)}$$

$$\text{Data processing time} = \{(4 + 4) \times 8\} \times 0.00254 + 8 \times 0.472 + 6 = 9.94 \text{ ms}$$

$$\text{Minimum data link transmission delay} = 18 \times 3 = 54 \text{ ms}$$

$$\text{Maximum data link transmission delay} = 30 + 18 \times 2 + 30 \times 3 + 6 = 162 \text{ ms}$$

Synchronization Operation with Communications Cycle Time Larger than PC's Cycle Time

The minimum data link transmission delay is shown in the following timing chart.

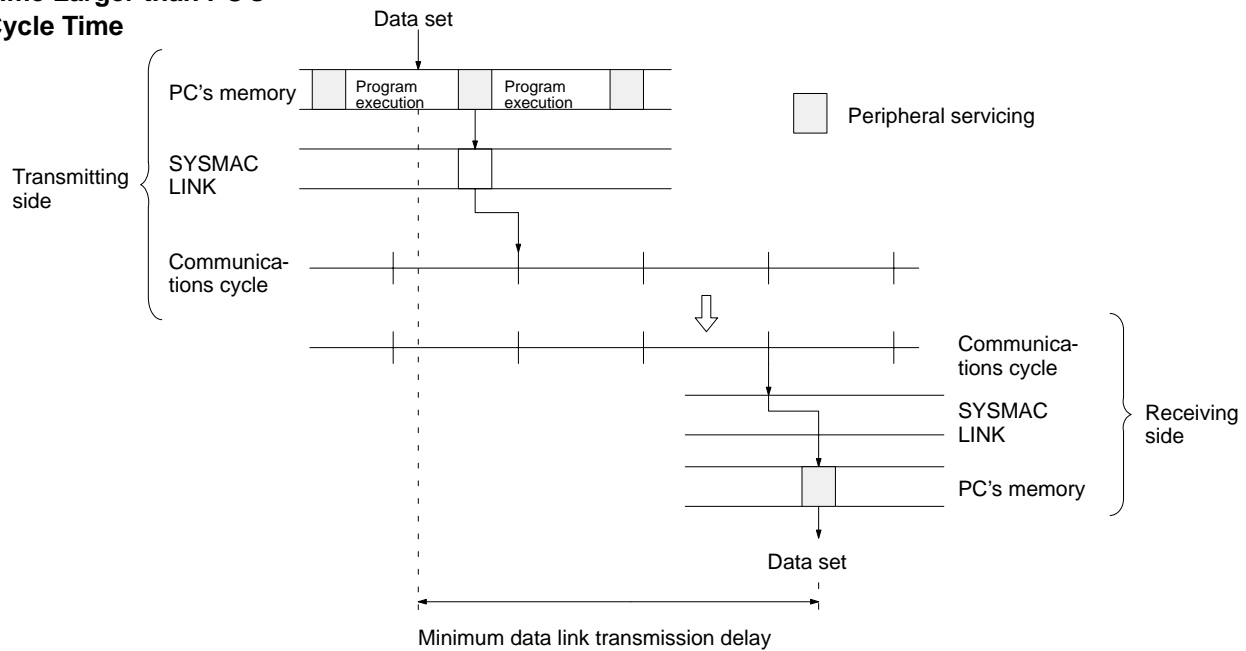

Calculate the minimum data link transmission delay as follows:
 Minimum data link transmission delay (ms) = Communications cycle time x 3

Note When data processing time is larger than communications cycle time, apply the following formula:
 Minimum data link transmission delay (ms) = Communications cycle time x 4

The maximum data link transmission delay is shown in the following timing chart.

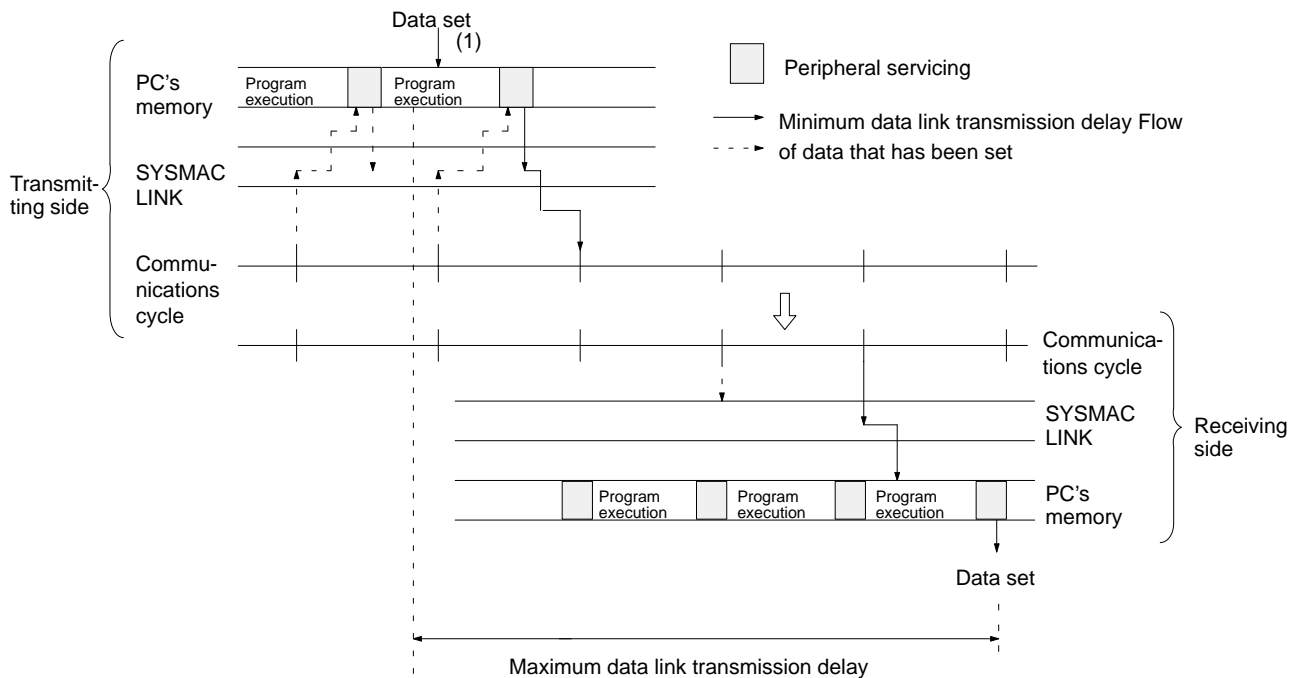

(1) The delay occurs because the command is executed right after the previous data exchange. A delay of approximately one communications cycle is caused by the processing of the command, and until then the next data exchange is not available. Calculate the maximum data link transmission delay as follows:
 Maximum data link transmission delay (ms) = Communications cycle time x 4 + Receiving PC's cycle time + 6

Note When data processing time is larger than communications cycle time, add the following to the above formula:
 PC's cycle time + communications cycle time x 2

Calculation Example

Condition

Transmission path: Coaxial cable

No. of link nodes: 32 nodes

No. of area words: 30 words, DM 60 words/node

Network parameters: Maximum node address: 62; Number of polled units: 4;

Number of frames transmitted per cycle: 10

Transmitting PC's cycle time: 20 ms

Receiving PC's cycle time: 30 ms

Communications cycle time (automatic generation) = $62 \times 0.085 + 10 \times 0.654 + 4 \times 0.75 + 32 \times 0.056 + \{(30 + 60) \times 32\} \times 0.01 + 1.322 = 46.72$ (47 ms)

Data processing time = $\{(30 + 60) \times 32\} \times 0.00254 + 32 \times 0.472 + 6 = 28.42$ ms

Minimum data link transmission delay = $47 \times 3 = 141$ ms

Maximum data link transmission delay = $47 \times 4 + 30 + 6 = 224$ ms

SECTION 6

Network Data Exchange

The CV-series PC allows data exchange between networks. This section provides the details of the data exchange functions of the CV-series PC via SYSMAC LINK Networks.

6-1	Data Exchange between Networks	56
6-1-1	Bridges and Gateways	56
6-1-2	Data Flow	56
6-1-3	Settings	57
6-2	Routing Tables	57
6-2-1	Routing Table Structure	57
6-2-2	Local Network Table	57
6-3	Relay Network Tables	58
6-4	Routing Table Examples	59

6-1 Data Exchange between Networks

If more than one SYSMAC NET Link Unit and/or SYSMAC LINK Unit is mounted on a PC, these Units will make it possible for a node on the network to exchange data with a node on a different network.

6-1-1 Bridges and Gateways

The CV-series PCs can operate as both bridges and gateways between networks.

Bridges

The bridge function of the PC allows data exchange between two SYSMAC LINK Networks. To use the bridge function, it is necessary to mount more than one SYSMAC LINK Unit on the same PC.

Gateways

The gateway function allows data exchange between different types of network such as the SYSMAC LINK and SYSMAC NET Link Networks or the SYSMAC LINK Network and SYSMAC BUS/2 Remote I/O System. When a bridge is used, the user need not monitor the kinds of networks because the communications protocol is converted automatically.

Note Data exchange between a nodes on two different networks separated by a third network is possible, but data exchange is not possible if more than one network exists between the networks.

6-1-2 Data Flow

The following graphics show the flow of data from one network to another. In this example, data is sent from PC (A) on node 1 of network 1 to PC (C) on node 2 of network 2.

- 1, 2, 3...**
1. The SYSMAC LINK Unit (unit no. 2) on node 2 of network 1 receives a command sent from PC (A).
 2. The SYSMAC LINK Unit transfers the command to the SYSMAC LINK Unit (unit no. 1) on node 1 mounted on PC (B) using the PC's bridge function.
 3. The SYSMAC LINK Unit on node 1 transfers the command to PC (C) on its local network (network 2).
 4. PC (C) transmits the response for the command to PC (A) via the communication path in the reverse direction.

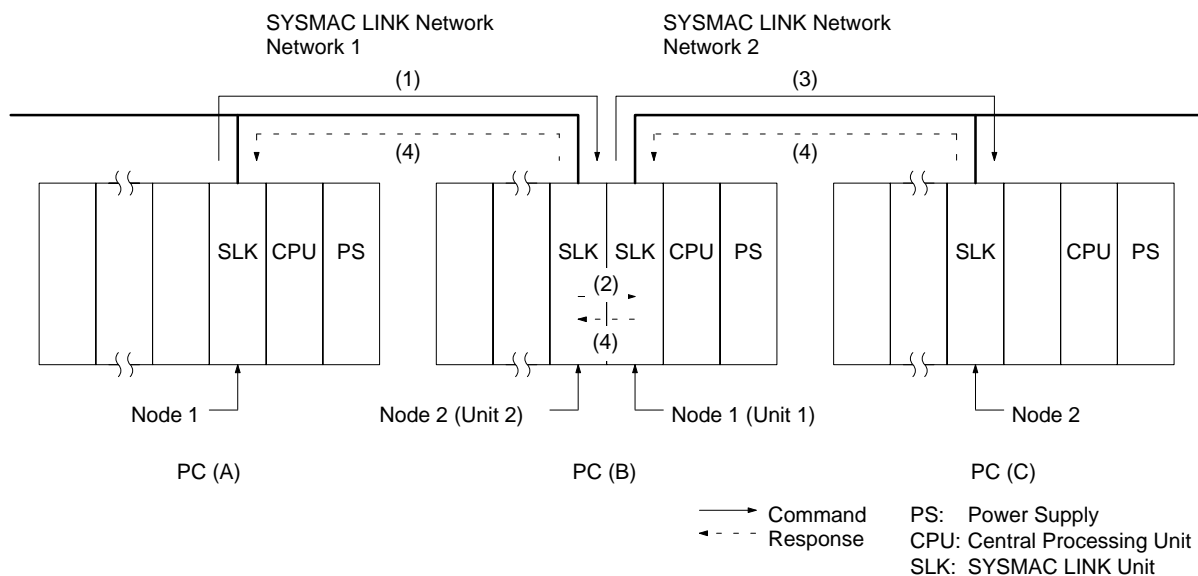

Although two SYSMAC LINK Networks are bridges to each other in the above example, the gateway function of the relay node (PC (B) in the above example) could also serve as a gateway to connect different types of networks if one of the Units was a SYSMAC NET Link Unit.

6-1-3 Settings

For data exchange between networks, it is necessary to set routing tables on the PC with the CVSS. The SYSMAC LINK Unit reads the contents of routing tables from the PC at the moment power is turned on or the Unit is reset. A node without routing tables cannot exchange data with other nodes on other networks.

- Note**
1. If routing tables are set with the CVSS, the Unit will be automatically reset. The Unit, however, will not be automatically reset if a routing table is set from a host computer. Thus, it is necessary to reset the Unit after setting the routing tables
 2. A routing table cannot be set on a node if the network is not connected to a host computer or the CVSS.

6-2 Routing Tables

Routing tables are required for data exchange with other networks or when more than one SYSMAC LINK Unit or SYSMAC NET Link Unit is mounted on the PC. For data exchange with other networks, set a routing table on the local node, destination node, and relay node from a host computer or the CVSS. Refer to the CVSS manuals for details.

6-2-1 Routing Table Structure

The routing tables consist of a local network table and relay network table and determines the communications path for data exchange between networks.

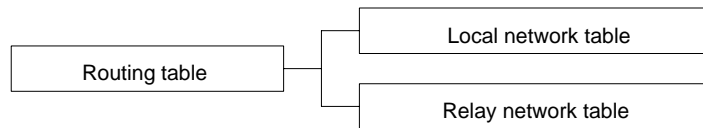

6-2-2 Local Network Table

If more than one SYSMAC NET Link Unit or SYSMAC LINK Unit is mounted on the PC, a local network table is required. The local network table has a list of each network and its corresponding Unit.

- Note** The SYSMAC BUS/2 Remote I/O System has no network address. That is why the Remote I/O Master is not registered with any local network table.

Contents

Two data items are set on each Unit as follows:

- 1, 2, 3... 1. Local network: Network address of the Unit (1 to 127)
2. CPU Bus Unit no.: Unit no. (0 to 15) of the SYSMAC NET Link Unit or SYSMAC LINK Unit

Configuration of Local Network Table

The local network table setting CVSS display is as follows:

[Local Network Table]

#	Loc Netwk	SIU unit #	#	Loc Netwk	SIU unit #
1			9		
2			10		
3			11		
4			12		
5			13		
6			14		
7			15		
8			16		

6-3 Relay Network Tables

To exchange data between two networks, you must set up a relay network table that specifies the data transmission path for remote networks.

Setting Data

Data transmission paths include the following.

Item	Range	Contents
Destination network	1 to 127	The network address of the designated node
Relay network	1 to 127	The address of the network through which the destination network can be reached
Relay node	1 to 62 (1 to 126 for SYSMAC NET)	The address of the node on the relay network through which the destination network can be reached

The relay network table display will appear on the CVSS as shown below. You can register up to 20 destination networks.

[Relay Network Table]

#	End Netwk	Relay		
		PC ID	Netwk	node
1	002		001	001
2				
3				
4				
5				
6				
7				
8				
9				
10				
11				
12				
13				
14				
15				
16				
17				
18				
19				
20				

Each node can be assigned a unique PC name (PC ID). If a node has a PC name (the name of the PC on the node), you need not designate the network address or node address. For details, refer to the *CVSS Operation Manual: Online*.

Note When routing tables are transferred to the PC from a computer, the SYSMAC LINK Unit and SYSMAC NET Link Unit will be reset.

6-4 Routing Table Examples

Local Network Table with More Than One Unit

The following illustration shows an example of routing table settings for a single PC mounted with more than one Unit. The PC shown here belongs to two networks that require routing tables, and there are thus two entries in the local network table. The SYSMAC BUS/2 System does not have a network address and is not registered on the local network table.

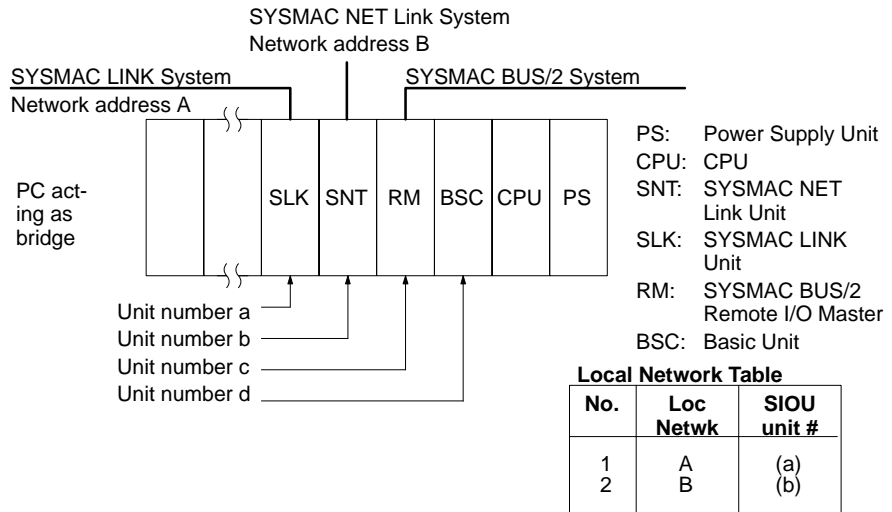

Three Connected Networks

The following illustration shows an example of routing table settings with three networks connected to one another. Take a look at the relay network table for PC 3. When network A is the destination network for PC 3, B is the relay network and c is the relay node. When network C is the destination network, B is the relay network and e is the relay node.

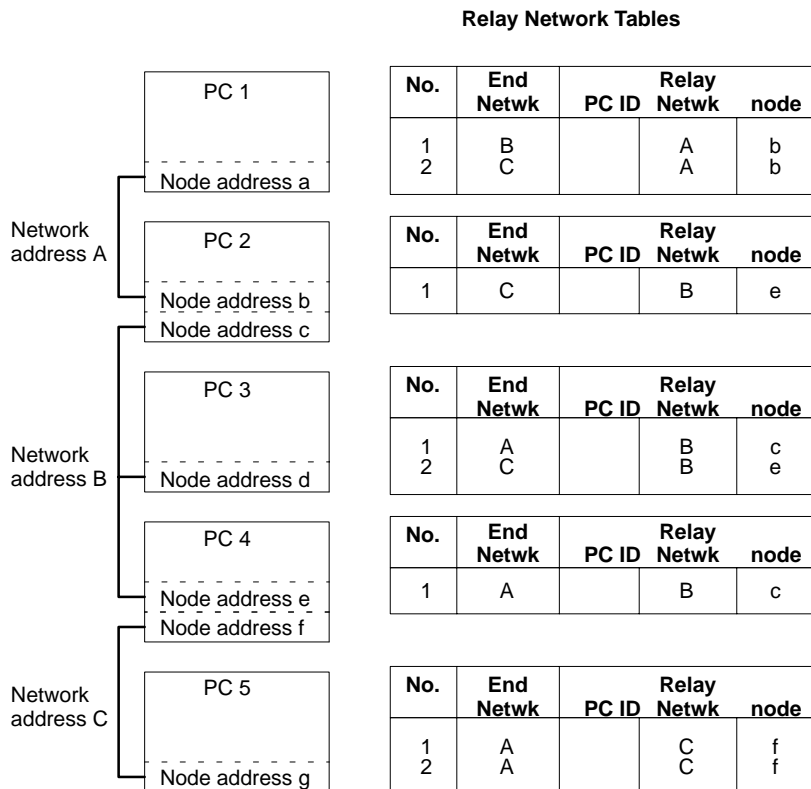

Actual Example

The routing tables shown below are for the following real-life system.

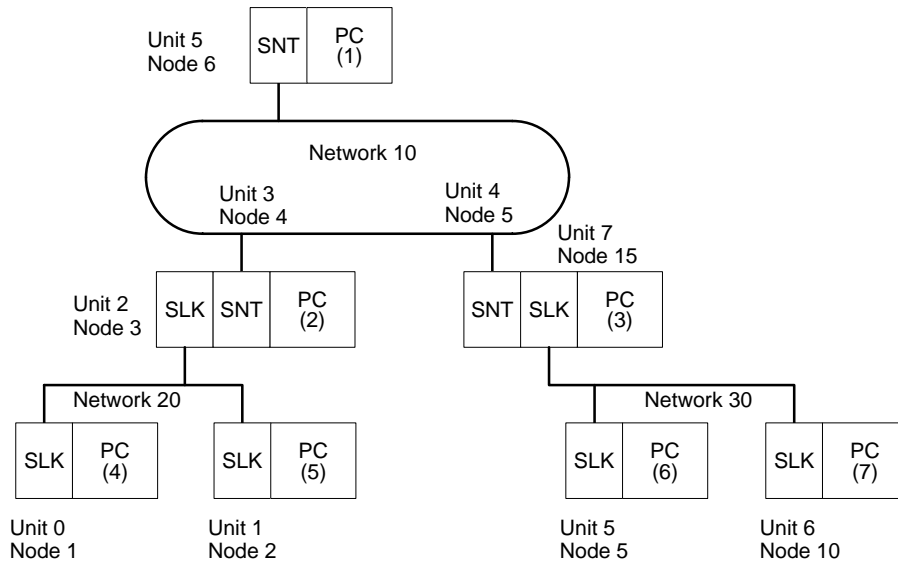

Routing Tables on PC 1

Local Network Table

No.	Loc Netwk	SIOU unit #
1	010	05
2		
3		

Relay Network Table

No.	End Netwk	PC ID	Relay Netwk	node
1	020		010	004
2	030		010	005
3				

Routing Tables on PC 2

Local Network Table

No.	Loc Netwk	SIOU unit #
1	010	03
2	020	02
3		

Relay Network Table

No.	End Netwk	PC ID	Relay Netwk	node
1	030		010	005
2				
3				

Routing Tables on PC 3

Local Network Table

No.	Loc Netwk	SIOU unit #
1	010	04
2	030	07
3		

Relay Network Table

No.	End Netwk	PC ID	Relay Netwk	node
1	020		010	004
2				
3				

Routing Tables on PC 4

Local Network Table

No.	Loc Netwk	SIOU unit #
1	020	00
2		
3		

Relay Network Table

No.	End Netwk	PC ID	Relay Netwk	node
1	010		020	003
2	020		020	003
3				

Routing Tables on PC 5

Local Network Table			Relay Network Table				
No.	Loc Netwk	SIOU unit #	No.	End Netwk	PC ID	Relay Netwk	node
1	020	01	1	010		020	003
2			030	020		003	
3							

Routing Tables on PC 6

Local Network Table			Relay Network Table				
No.	Loc Netwk	SIOU unit #	No.	End Netwk	PC ID	Relay Netwk	node
1	030	05	1	010		030	015
2			020	030		015	
3							

Routing Tables on PC 7

Local Network Table			Relay Network Table				
No.	Loc Netwk	SIOU unit #	No.	End Netwk	PC ID	Relay Netwk	node
1	030	06	1	010		030	015
2			020	030		015	
3							

Using Routing Tables

The following describes how the above routing tables are used for data transmission from PC 1 to PC 6 using the SEND(192), RECV(193), or CMND(194) instructions.

- 1, 2, 3...**
1. PC 1 checks the local routing table (relay network table), and to send the data to network 30, where PC 6 exists, and PC 1 transfers the data to node 5 (PC 3) on network 10.
 2. PC 3 receives the data from PC 6, checks the local routing table (local network table), and sends the data to node 5 (PC 6) via CPU Bus Unit (Unit 7), which is connected to network 30.
 3. PC 6 checks the local routing table (local network table) and confirms that the data transmitted to node 5, network 30, is for PC 6. Then PC 6 retrieves the data.

SECTION 7

Data Read/Write Services

This section describes the PC instructions and network commands that can be used to transfer data and control operation via a SYSMAC LINK System.

7-1	About Data Read/Write Services	65
7-2	PC Network Instructions	65
7-2-1	Communications Specifications	66
7-2-2	PC Memory Areas	66
7-2-3	Communications Ports	66
7-2-4	NETWORK SEND Instruction – SEND(192)	68
7-2-5	NETWORK RECEIVE Instruction – RECV(193)	70
7-2-6	DELIVER COMMAND Instruction – CMND(194)	72
7-2-7	Program Example	75
7-2-8	Delay Times	76
7-3	CV-mode Command/Response Format	79
7-4	CV-mode Command Lists	80
7-4-1	Commands for PCs (CV-mode Commands)	80
7-4-2	Commands for SYSMAC LINK Units (CV-mode Commands)	81
7-5	Response Codes	82
7-6	Memory Area Designations	82
7-7	Volume Labels and File Names	84
7-8	CV-mode Commands for PCs	84
7-8-1	MEMORY AREA READ	84
7-8-2	MEMORY AREA WRITE	85
7-8-3	MEMORY AREA FILL	86
7-8-4	MULTIPLE MEMORY AREA READ	87
7-8-5	MEMORY AREA TRANSFER	88
7-8-6	PARAMETER AREA READ	89
7-8-7	PARAMETER AREA WRITE	90
7-8-8	PARAMETER AREA CLEAR	93
7-8-9	PROGRAM AREA PROTECT	94
7-8-10	PROGRAM AREA PROTECT CLEAR	95
7-8-11	PROGRAM AREA READ	95
7-8-12	PROGRAM AREA WRITE	96
7-8-13	PROGRAM AREA CLEAR	97
7-8-14	RUN	97
7-8-15	STOP	98
7-8-16	CONTROLLER DATA READ	98
7-8-17	CONNECTION DATA READ	100
7-8-18	CONTROLLER STATUS READ	100
7-8-19	CYCLE TIME READ	102
7-8-20	CLOCK READ	102
7-8-21	CLOCK WRITE	103
7-8-22	MESSAGE READ	103
7-8-23	MESSAGE CLEAR	104
7-8-24	FAL/FALS READ	105
7-8-25	ACCESS RIGHT ACQUIRE	105
7-8-26	ACCESS RIGHT FORCED ACQUIRE	106
7-8-27	ACCESS RIGHT RELEASE	107
7-8-28	ERROR CLEAR	107

7-8-29	ERROR LOG READ	109
7-8-30	ERROR LOG CLEAR	109
7-8-31	FILE NAME READ	110
7-8-32	SINGLE FILE READ	111
7-8-33	SINGLE FILE WRITE	112
7-8-34	MEMORY CARD FORMAT	113
7-8-35	FILE DELETE	113
7-8-36	VOLUME LABEL CREATE/DELETE	114
7-8-37	FILE COPY	114
7-8-38	FILE NAME CHANGE	115
7-8-39	FILE DATA CHECK	115
7-8-40	MEMORY AREA FILE TRANSFER	116
7-8-41	PARAMETER AREA FILE TRANSFER	117
7-8-42	PROGRAM AREA FILE TRANSFER	119
7-8-43	FORCED SET/RESET	120
7-8-44	FORCED SET/RESET CANCEL	120
7-9	CV-mode Commands for SYSMAC LINK Units	121
7-9-1	DATA LINK START	121
7-9-2	DATA LINK HALT	121
7-9-3	RESET	122
7-9-4	CONTROLLER DATA READ	122
7-9-5	CONTROLLER STATUS READ	122
7-9-6	NETWORK STATUS READ	124
7-9-7	DATA LINK STATUS READ	126
7-9-8	INTERNODE ECHO TEST	127
7-9-9	BROADCAST TEST RESULTS READ	127
7-9-10	BROADCAST TEST DATA SEND	128
7-9-11	ERROR LOG READ	128
7-9-12	ERROR LOG CLEAR	129

7-1 About Data Read/Write Services

A SYSMAC LINK Unit provides read/write services that can be used to transfer data and control other nodes on the network or interconnected networks.

The data read/write services use a command/response format. Each time that data or a command from a host computer or CV-series PC is transmitted, the receiving node returns a response. If responses aren't needed, the Unit can be set so that responses are not returned. The same transmission can also be broadcast simultaneously to all nodes on the network.

Data Read/Write Service Transmissions

The data read/write services with the SYSMAC LINK Unit can be divided into four processed, as described below.

Computer-originating Commands

A program is prepared in the computer that transmits commands and receives responses. (When programming in the C code, commands can be transmitted with `slksend` and responses received with `slkrecv` or `slkrcvw`.)

PC-originating Commands

Data is transmitted using the SEND(192), RECV(193), and CMND(194) instructions. You may need to move data being transferred to/from the location in memory specified in the instruction, but the actual transmission and reception is handled automatically.

Computer Responses

A program that returns proper responses for received commands must be prepared and loaded in the computer prior to command reception.

PC Responses

The SYSMAC LINK Unit receives and processes commands and returns the proper responses automatically. Since all of the processing is handled automatically, it isn't necessary to prepare a routine for command reception in the PC program.

7-2 PC Network Instructions

The PC's network instructions (SEND(192),RECV(193), and CMND(194)) can be used to transfer data within SYSMAC LINK and SYSMAC NET Link Systems. These instructions can be used in programming to send data to or request data from other nodes (PCs, computers, etc.) in the same System. Communication is also possible with specific CPU Bus Link Units by designating unit addresses.

It is possible to transfer the same data to all nodes in a network simultaneously by designating the destination node as FF. This transmission is called broadcast transmission. No responses are returned in broadcast transmission.

7-2-1 Communications Specifications

The basic specifications of the network instructions are given in the following table.

Transmission format	1:1 (SEND(192), RECV(193), or CMND(194)) 1:N (SEND(192) or CMND(194); data broadcast, no response)
Packet length	SEND(192)/RECV(193): 256 words (512 bytes) max. CMND(194): 542 bytes max.
Data content	When SEND(192) is executed, command/response for a request to send data are transferred. When RECV(193) is executed, command/response for a request to receive data are transferred. When CMND(194) is executed, a wide range of command/response data can be sent.
Response time-out parameters	0000: 2 s 0001 to FFFF: user settings (in increments of 0.1 s, 0.1 to 6553.5 s)
Communications ports	Ports 0 to 7 (8 ports can be used at the same time for data exchange)
Number of retries	0 to 15

7-2-2 PC Memory Areas

The memory areas that can be used for data transfer depend on the model of PC, as shown in the following table. Be sure not to exceed the end of a memory area when sending or receiving data.

G000 to G007 and A256 to A511 are read-only and cannot be written. The Expansion Data Memory Area is available only if mounted as an option and then only for the number of banks provided by the optional Expansion Data Memory Unit.

Area	CV1000, CV2000, or CVM1-CPU11-E	CV500 or CVM1-CPU01-E
CIO Area	0000 to 2555	
Auxiliary Area	A000 to A511	
CPU Bus Link Area	G000 to G255	
DM Area	D00000 to D24575	D00000 to D08191
Expansion DM Area	E00000 to E32765 (8 banks) (CV1000 or CV2000 only)	Not supported.
Timer Area	T0000 to T1023	T000 to T0511
Counter Area	C0000 to C1023	C000 to C0511

Note When writing data to a C200H PC, the write life must be considered if an EEPROM Memory Unit is being used and data is being written to words between DM 1000 and DM 1999. Because these words are contained in the EEPROM, they can be written only a certain number of times. If frequent writing to these words is required using SEND(192), use a RAM Memory Unit instead of an EEPROM Memory Unit.

7-2-3 Communications Ports

When the SEND(192), RECV(193), or CMND(194) instructions have been executed, the status of the execution will be stored in the Auxiliary Area of the PC according to the communications port. Using this status information, the PC can adjust the timing of SEND(192), RECV(193), or CMND(194) execution from the user's program.

Timing Communications Ports

Eight communications ports can be used simultaneously to execute the SEND(192), RECV(193), or CMND(194) instructions, but only one instruction cannot be executed at the same time for each port. To execute more than one instructions in sequence at the same port, use the Port Enabled Flags to be sure that a port is not busy before executing a new instruction for it. Port Enabled Flags are contained in the status data provided in PC memory for network communications.

Configuration of Status Data

The following table shows the configuration of the status data in the Auxiliary Area.

Word	Bits 15 to 8	Bits 7 to 0
A502	Port Execute Error Flags	Port Enabled Flags
A503	Completion code for port 0	
A504	Completion code for port 1	
A505	Completion code for port 2	
A506	Completion code for port 3	
A507	Completion code for port 4	
A508	Completion code for port 5	
A509	Completion code for port 6	
A510	Completion code for port 7	

Port Enabled Flags (Bits 0 to 7 of A502)

Each bit in A502 corresponds to one of the ports. Be sure that the bit for the port of ON before executing an instruction for it.

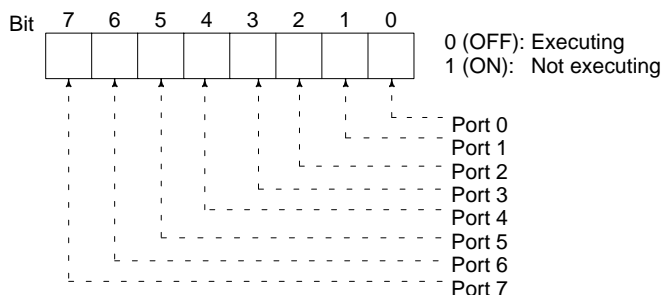

Port Execute Error Flags (Bits 0 to 8 of A502)

Each bit in A502 corresponds to the on of the ports. These flags can be checked upon completion of an instruction to be sure that it was executed normally. The status of these flags will be held until the next instruction is executed for that port.

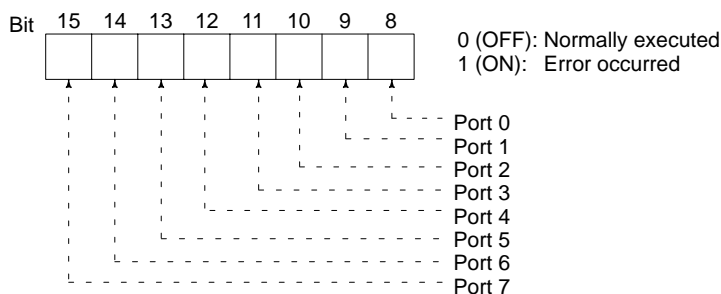

Completion Codes (Words A503 to A510)

The status after execution of an instruction will be shown by the completion code. The completion code will be held until the next instruction is executed for that port. The completion code will be 0000 while an instruction is being executed. The completion codes are identical to the response codes returned with the response to a command. Refer to Section 9 Error Processing for details.

Flag Timing

The following timing chart shows the timing of the Port Enabled Flag, Port Execute Error Flag, and completion codes. In this example two commands were executed for port 0 but there was an error for command 1.

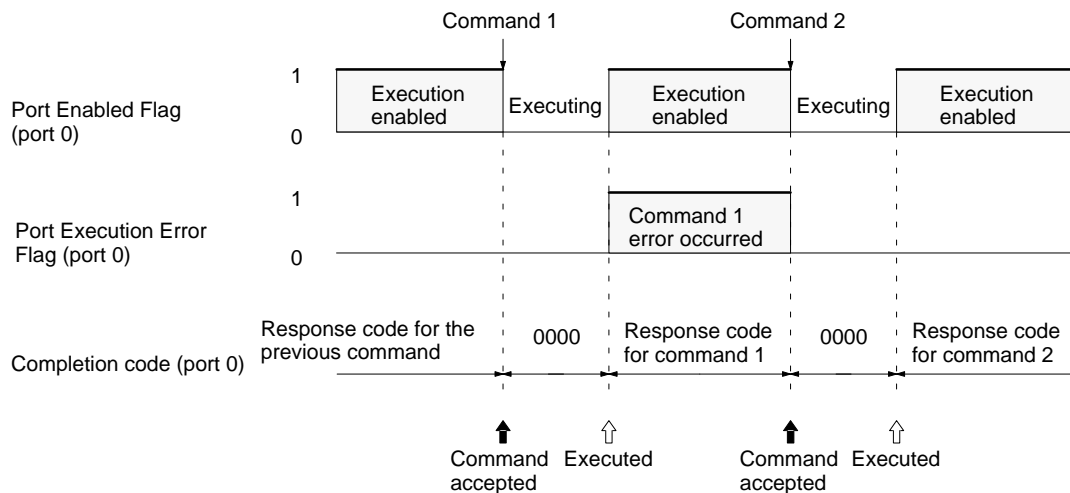

Note The new data will be sent if the data in the transmission area is changed while an command is being executed. Do not change data in the area being transmitted unless the Port Enabled Flag is ON (1).

CMND(194) Instructions

The following will affect the Port Execute Error Flag and completion code when you have executed the CMND(194) instruction.

- 1, 2, 3...**
1. A response time-out error.
 2. The number of transmission data bytes exceeding the maximum permissible range (more than 021E (542) bytes for SYSMAC LINK Units).
 3. The number of response data bytes exceeding the number of reception data bytes that was set (in this case, no response will be recorded).

Errors other than the above will be shown in the response code in the response block but will not be shown in the Port Execution Error Flag or completion codes.

7-2-4 NETWORK SEND Instruction – SEND(192)

The SEND(192) instruction allows a PC to write data to the memory of a device located at a node on a local or remote network.

Format

The format of the SEND(192) instruction is as follows:

Ladder Symbol	Operand Data Areas
<p>(192)</p> <p>— [SEND S D C]</p> <p>Variations</p> <p>↑ SEND(192)</p>	<p>S: 1st source word CIO, G, A, T, C, DM, DR*, IR*</p> <p>D: 1st destination word CIO, G, A, T, C, DM, DR*, IR*</p> <p>C: 1st control word CIO, G, A, T, C, DM, DR*, IR*</p> <p>*Indirect addressing only</p>

Control Data

Set the destination node address to \$FF to broadcast the data to all nodes in the designated network or to \$00 to send to a destination within the node of the PC executing the send.

Word	Bits 00 to 07	Bits 08 to 15
C	Number of words (1 to 256 in 4-digit hexadecimal, i.e., \$0001 to \$0100)	
C+1	Destination network address (0 to 127, i.e., \$00 to \$7F)	Bits 08 to 11: Interrupt number Bits 12 to 15: Set to 0.
C+2	Destination unit address	Destination node address
C+3	Bits 00 to 03: No. of retries (0 to 15 in hexadecimal, i.e., \$0 to \$F) Bits 04 to 07: Set to 0.	Bits 08 to 11: Port number (\$0 to \$7) Bit 12 to 14: Set to 0. Bit 15: ON: No response. OFF: Response returned.
C+4	Response monitoring time (\$0001 to \$FFFF = 0.1 to 6553.5 seconds)	

Note Transmissions cannot be sent to the PC executing the send.

1, 2, 3...

1. Number of Words
Set the total number of words to be transferred.
2. Interrupt Number
The BASIC Unit interrupt (subroutine) number is used when a BASIC Unit is designated. Set the interrupt number to 0 when sending to any destination other than a BASIC Unit.
3. Destination Network Address
Set the destination network address to 00 if the destination network address is a local network. If more than one SYSMAC LINK Unit or SYSMAC NET Link Unit is mounted to the PC, the network of the Unit with the smallest unit number will be considered to be the local network.
4. Destination Node Address
Set the destination node address to FF for broadcasting within the local network. Set to 00 (and set the network address to 00) for transmission to a device at the local node.
5. Destination Unit Address
Set the destination unit to 00 if the destination is a PC. If the destination is a user's application on a computer (NSB), set the destination unit number to 01 (user application 1). For a BASIC Unit, add 10 to the unit number (0 to F) so that the destination unit address is from 10 to 1F.

Destination	Address (hexadecimal)
PC (CPU)	00
NSB (computer)	01 (user application 1)
BASIC Unit	Unit no. + 10 (10 to 1F for Unit 0 to F (0 to 15))

6. Response Flag (Bit 15 of C+3)
Usually set this bit to OFF (0: required). If you do not need any response, set the bit to ON (1: not required).
7. Port No.
Set the communications port number that the SEND(192) instruction will be sent from.
8. Number of Retries
Set the number of retries for unsuccessful transmissions. You can set the number between 1 to 15. If 15 has been set, for example, the SEND(192) instructions will be re-transmitted up to 15 times when the PC does not receive a response from the destination node.

9. Response Monitor Time (Unit: 0.1 S)
Designates the length of time that the PC retries transmission when bit 15 of C+3 is OFF and no response is received. The default value is \$0000, which indicates 2 seconds. The response function is not used when the destination node address is set to \$FF, broadcasting to all nodes in the network.

Range of Control Data

The permissible ranges of control data to be set are as follows:

Item	Value
Number of words	0001 to 0100 (1 to 256 words)
Interrupt number	0: PC or computer 1 to F (1 to 15): BASIC Unit
Destination network address	00: Local network 01 to 7F: Destination network address
Destination node address	00: Transmission within local node 01 to 7E: Destination node address (1 to 126) (SYSMAC NET) 01 to 3E: Destination node address (1 to 62) (SYSMAC LINK) FF: Broadcasting
Destination unit address	00: PC 01: Computer (NSB) user application 1 10 to 1F: BASIC Unit (unit numbers 0 to F)
Response flag	0 (OFF): Required 1 (ON): Not required
Communications port number	0 to 7 (0 to 7)
Number of retries	0 to F (0 to 15)
Response monitor time	0000: 2 s (default) 0001 to FFFF: 0.1 to 6,553.5 s with 0.1-s increments (set by the user)

Note When broadcasting, there is no response from the nodes.

7-2-5 NETWORK RECEIVE Instruction – RECV(193)

The RECV(193) instruction enables the local node to write to its memory, data sent from a node either on a local or remote network.

Format

The format of the RECV(193) instruction is as follows:

Ladder Symbol	Operand Data Areas
(193) — [RECV S D C]	S: 1st source word CIO, G, A, T, C, DM, DR*, IR*
	D: 1st destination word CIO, G, A, T, C, DM, DR*, IR*
Variations ↑ RECV(193)	C: 1st control word CIO, G, A, T, C, DM, DR*, IR*
	*Indirect addressing only

Control Data

Set the source node address to \$00 to send data within the PC executing the instruction.

Word	Bits 00 to 07	Bits 08 to 15
C	Number of words (1 to 256 in 4-digit hexadecimal, i.e., \$0001 to \$0100)	
C+1	Source network address (0 to 127, i.e., \$00 to \$7F)	Bits 08 to 11: Interrupt number Bits 12 to 15: Set to 0.
C+2	Source unit address	Source node address
C+3	Bits 00 to 03: No. of retries (0 to 15 in hexadecimal, i.e., \$0 to \$F) Bits 04 to 07: Set to 0.	Bits 08 to 11: Port number (\$0 to \$7) Bit 12 to 14: Set to 0. Bit 15: ON: No response. OFF: Response returned.
C+4	Response monitoring time (\$0001 to \$FFFF = 0.1 to 6553.5 seconds)	

Note Transmissions cannot be received from the PC executing RECV(193).

- 1, 2, 3...**
1. Number of Words
Set the total number of words to be transferred.
 2. Interrupt Number
The BASIC Unit interrupt (subroutine) number can be set when a BASIC Unit is designated. Set the interrupt number to 0 when sending to any destination other than a BASIC Unit.
 3. Source Network Address
Set the Source network address to 00 if you send the data to within the local network. If more than one SYSMAC LINK Unit or SYSMAC NET Link Unit is mounted to the PC, the network of the Unit with the smallest unit number will be considered to the local network.
 4. Source Node Address
Set the source node address to 00 for devices at the local node.
 5. Source Unit Address
Set the source unit number to 00 if the destination is a PC. If it is a user application on a computer, set the destination unit to 01 (user application 01). For a BASIC Unit, add 10 to the unit number (0 to F) so that the destination unit address is from 10 to 1F.

Destination	Address (hexadecimal)
PC (CPU)	00
NSB (computer)	01 (user application 1)
BASIC Unit	Unit no. + 10 (10 to 1F for Unit 0 to F (0 to 15))

6. Port Number
Set the communications port number that the RECV(193) instruction will be sent to.
7. Number of Retries
Set the number of retries for unsuccessful transmissions. You can set the number between 1 to 15. If 15 has been set, for example, the RECV(193) instructions will be re-transmitted up to 15 times when the PC does not receive a response from the destination node.
8. Response Monitor Time
Designates the length of time that the PC retries transmission when bit 15 of C+3 is OFF and no response is received. The default value is \$0000, which indicates 2 seconds.

Range of Control Data

The permissible ranges of control data to be set are as follows:

Item	Value
Number of words	0001 to 0100 (1 to 256 words)
Interrupt number	0: Computer 1 to F (1 to 15): BASIC Unit
Source network address	0: Local network 01 to 7F: Source network address
Source node address	00: Transmission within local PC 01 to 7E: Source node address (1 to 126) (SYSMAC NET) 01 to 3E: Source node address (1 to 62) (SYSMAC LINK) FF: Broadcasting
Source unit address	00: PC 01: Computer (NSB), user application 1 10 to 1F: BASIC Unit (for unit numbers 0 to F)
Communications port number	0 to 7 (0 to 7)
Number of retries	0 to F (0 to 15)
Response monitor time	0000: 2 s (default) 0001 to FFFF: 0.1 to 6,553.5 s in 0.1-s increments (set by the user)

7-2-6 DELIVER COMMAND Instruction – CMND(194)

The CMND(194) instruction is used to send specific commands to transfer data or to control operation at the destination node. When a command is sent, a response is returned. Specifically, the CMND(194) instruction transmits a command beginning at word S to the designated Unit at the destination node address in the designated network and receives the response beginning at word D. Refer to 7-8 CV-mode Commands for PCs and 7-9 CV-mode Commands for SYSMAC LINK Units for the commands that can be sent and the responses received.

Format

The format of the CMND(194) instruction is as follows:

<p>Ladder Symbol</p> <p style="text-align: center;">(194)</p> <p>— [CMND S D C]</p> <p>Variations</p> <p>↑ CMND(194)</p>	<p>Operand Data Areas</p> <p>S: 1st command word CIO, G, A, T, C, DM, DR*, IR*</p> <p>D: 1st response word CIO, G, A, T, C, DM, DR*, IR*</p> <p>C: 1st control word CIO, G, A, T, C, DM, DR*, IR*</p> <p>*Indirect addressing only</p>
--	---

Control Data

The control words, beginning with C, specify the number of bytes of control data to be sent, the number of bytes of response data to be received, the destination node, and other parameters.

Word	Bits 00 to 07	Bits 08 to 15
C	Number of bytes to send (2 to 542, i.e., \$0002 to \$021E) ¹	
C+1	Number of bytes to receive (2 to 542, i.e., \$0002 to \$021E) ¹	
C+2	Destination network address (0 to 127, i.e., \$00 to \$7F) ²	Bits 08 to 11: Interrupt number ³ Bits 12 to 15: Set to 0.
C+3	Destination unit address ⁴	Destination node address ⁵
C+4	Bits 00 to 03: No. of retries (0 to 15 in hexadecimal, i.e., \$0 to \$F) Bits 04 to 07: Set to 0.	Bits 08 to 11: Port number (\$0 to \$7) Bit 12 to 14: Set to 0. Bit 15: ON: No response. OFF: Response returned.
C+5	Response monitoring time (\$0001 to \$FFFF = 0.1 to 6553.5 seconds) ⁶	

Note Transmissions cannot be sent to the PC executing CMND(194).

- 1, 2, 3...**
1. Number of Bytes to Send
Set the total number of bytes of command data (including command code) stored at the first command and following words of the command block.
 2. Number of Bytes to Receive
Set the total number of bytes of response data (including response code) to be stored at the first response and following words of the response block.
 3. Interrupt Number
The BASIC Unit interrupt (subroutine) number can be set when a BASIC Unit is designated. Set the interrupt number to 0 when sending to any destination other than a BASIC Unit.
 4. Destination Network Address
Set the destination network address to 00 if sending the command to a node in the local network. If more than one SYSMAC LINK Unit or SYSMAC NET Link Unit is mounted to the PC, the network of the Unit with the smallest unit number will be considered to be the local network.

5. Destination Node Address

Set the destination node address to FF for broadcasting within the local network. Set to 00 (and set the network address to 00) for transmission to a device at the local node. The destination node address can have the following values:

System/type of transmission	Possible values
SYSMAC NET Link System	\$01 to \$7E (nodes 1 to 126)
SYSMAC LINK System	\$01 to \$3E (nodes 1 to 62)
Broadcast to all nodes in network	\$FF
Transmit within the PC	\$00

6. Destination Unit Address

Set the network destination address as follows:

Destination	Designation (hexadecimal)
PC (CPU)	00
SYSMAC LINK or SYSMAC NET	FE
Computer (NSB)	00 (server demon)
Computer (NSB)	01 (user application 1)
CPU Bus Unit	Unit no. + 10 (10 to 1F for Unit 0 to F (0 to 15))
SYSMAC BUS/2 Group-2 Slave	Master number x 10 + Group-2 Slave's unit number + 90

7. Response Flag

Usually set this bit to OFF (0: required). If no response is required, set the bit to ON (1: Not required).

8. Communications Port Number

Set the communications port number that the CMND(194) instruction will be sent to.

9. Number of Retries

Set the number of retries for unsuccessful transmissions. You can set the number between 1 to 15. If 15 has been set, for example, the CMND(194) instructions will be re-transmitted up to 15 times when the PC does not receive a response from the destination node.

10. Response Monitor Time (Unit: 0.1 S)

Designates the length of time that the PC retries transmission when bit 15 of C+3 is OFF and no response is received. The default value is \$0000, which indicates 2 seconds.

Note If more than the *number of bytes to receive* is received, no response will be stored. If fewer bytes are received, the response data will be stored and the unused memory area of the PC will remain unchanged.

Range of Control Data

The permissible ranges of control data are as follows:

Item	Value
Number of bytes to send	0002 to 021E (2 to 542 bytes)
Number of bytes to receive	0002 to 021E (2 to 542 bytes)
Destination network address	00: Local network 01 to 7F: Destination network address
Destination node address	00: Transmission within local PC 01 to 7E: Destination node address (1 to 126) (SYSMAC NET) 01 to 3E: Destination node address (1 to 62) (SYSMAC LINK) FF: Broadcasting
Destination unit address	00: PC 00: Computer (NSB), server demon 01: Computer (NSB), user application 1 FE: SYSMAC NET Link Unit or SYSMAC LINK Unit 10 to 1F: BASIC Unit (unit number: 0 to F)
Response flag	0 (OFF): Required 1 (ON): Not required
Communications port number	0 to 7 (0 to 7)
Number of retries	0 to F (0 to 15)
Response monitor time	0000: 2 s (default) 0001 to FFFF: 0.1 to 6,553.5 s with 0.1-s increments (set by the user)

Note In the case of broadcasting, set the response flag bit to ON (1: not required).

7-2-7 Program Example

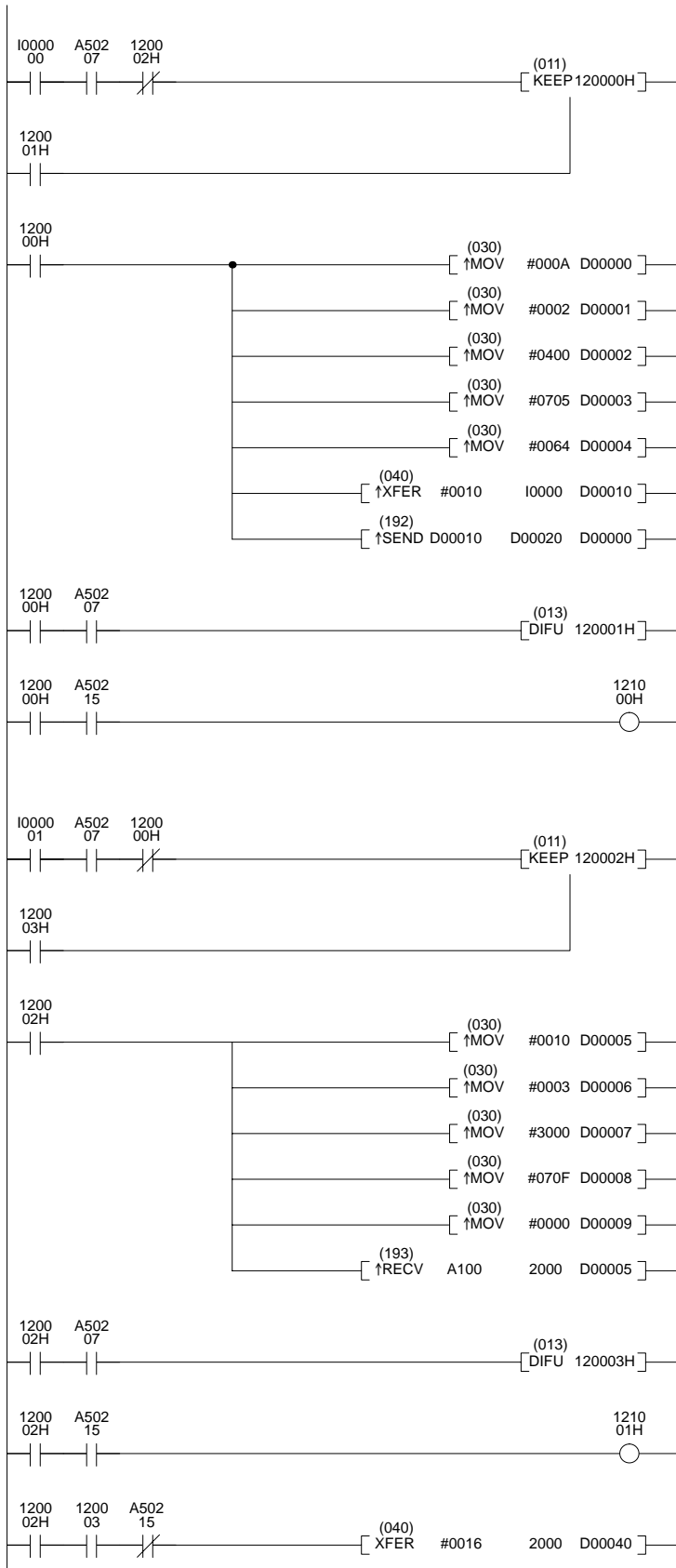

The SEND(192) program section will run when I000000 is ON, provided that the Enabled Flag for port 7 is ON and the RECV(193) instruction has not been executed.

120000H is ON while the SEND(192) instruction is being executed, and it goes OFF when the execution of the instruction has been completed.

The 10-word data starting from D00010 on the local PC is sent to D00020 and following words on the PC with a unit address of 0, node address of 4, and network address of 2.

Word	Content	Meaning
D00000	00 0A	Number of words: 10
D00001	00 02	Destination network address: 2
D00002	04 00	Destination node address: 4 Destination unit address: 0
D00003	07 05	Communications port no.: 7 Number of retries: 5
D00004	00 64	Response monitor time: 10 s

Storing the Send Data
The 10-word data starting from I0000 is stored in D00010 and following words.

Transmission error display

The RECV(193) program will run when I000001 is ON, provided that the Enabled Flag for port 7 is ON and the SEND(192) instruction has not been executed.

120002H is ON while the RECV(193) instruction is being executed, and it goes OFF when the execution of the instruction has been completed.

The 16-word data starting from A100 on the PC with a unit address of 0, node address of 48, network address of 3 is stored at 2000 and following words at the local PC.

Word	Content	Meaning
D00005	00 10	Number of words: 16
D00006	00 03	Destination network address: 3
D00007	30 00	Destination node address: 48 Destination Unit address: 0
D00008	07 0F	Communications port no.: 7 Number of retries: 15
D00009	00 00	Response monitor time: Default

Reception error display

Reception data processing
When the data is received without an error, the 16-word data received at 2000 and following words is stored in D00040 and following words on the same PC.

Note To execute more than one instruction in sequence at the same port, you must use the Port Enabled Flags to be sure that only one instruction is being executed at the same time for any one port.

7-2-8 Delay Times

The two charts which follow indicate the sequence of processing which will enable users to calculate the maximum delay time to be expected between the time SEND(192) or RECV(193) is executed and the time the data is stored in the remote or local node's memory area, ready for use by other instructions in the program.

SEND(192)

The following diagram indicates the data flow which will yield the maximum delay time from the time SEND(192) is executed by the user program to the time the SYSMAC LINK Unit stores the data in the destination Unit's memory.

Note Be sure to take into account the time required for data links and program execution, which are not included in the following example.

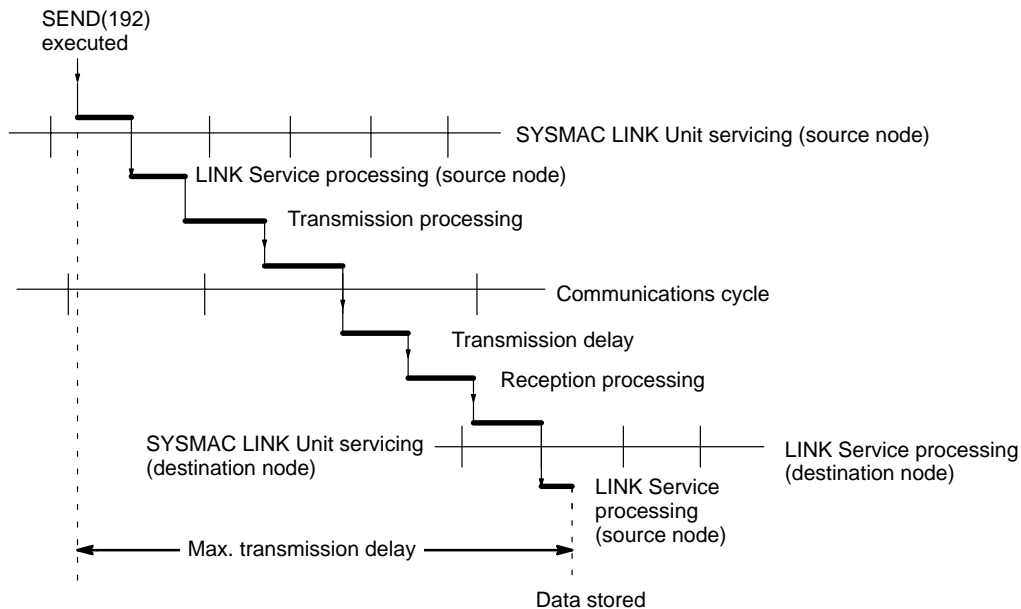

Max. transmission delay = LINK Unit servicing interval (source node) + Link service processing (source node) + Transmission processing + Communications cycle time + Transmission delay + Reception processing + LINK Unit servicing interval (destination node) + Link service processing (destination node)

Link Servicing Interval (Source and Destination Nodes)

Link servicing depends on the execution mode of the PC. The execution modes on the source and destination modes need not be the same.

For synchronous processing, links are serviced once per PC execution cycle. For non-synchronous processing, links are serviced according to the peripheral servicing interval. Refer to the *CV-series PC Operation Manual: Ladder Diagrams* for details.

Link Service Processing (Source and Destination Nodes)

Link service processing is the same as the PC's peripheral servicing and is approximately 1 ms for SYSMAC LINK Units.

Transmission and Reception Processing

Number of words transferred x 0.0045 ms + 4 ms

Communications Cycle Time

Coaxial: Max. node address × 0.01 ms + no. of nodes × 0.075 ms + no. of polled units × 0.75 ms + 1.322 ms

Optical: Max. node address × 0.01 ms + no. of nodes × 0.133 ms + no. of polled units × 0.75 ms + 1.322 ms

Transmission Delay

Number of words transferred × 0.008 ms + 0.204 ms

Note The I/O response time can increase due to noise or restrictions on the number of frames that can be transmitted while the data link is operating.

Example

In this example, the maximum transmission delay is calculated for an instruction sending 256 words of data in a system with 32 nodes. Network specifics are detailed below:

- Max. node address: 32
- Number of nodes: 32
- Number of polled units: 4
- Source node CPU execution processing: Synchronous
- Destination node CPU execution processing: Non-synchronous
- Number of words: 256
- Communications: coaxial cable
- Data link: halted

Delay cause	Maximum delay (ms)
Link servicing interval (source node)	PC cycle time
Link service processing (source node)	1 ms
Communications cycle time	$32 \times 0.01 + 32 \times 0.075 + 4 \times 0.75 + 1.322 = 7.042$ ms
Transmission processing	$256 \times 0.0045 + 4 = 5.152$ ms
Transmission delay	$256 \times 0.08 + 0.204 = 2.252$ ms
Reception processing	$256 \times 0.0045 + 4 = 5.152$ ms
Link servicing interval (destination node)	As required by peripheral device
Link service processing (destination node)	1 ms
Max. transmission delay	PC cycle time (source node) + Peripheral servicing interval (destination node) + 21.598 ms

**RECV(193) Instruction
Maximum Delay Time**

The data flow which will yield the maximum transfer interval from the time the RECV(193) instruction is executed by the user program to the time the SYSMAC LINK Unit stores the data in the local Unit's memory area is described below.

Note Be sure to take into account the time required for data links and program execution, which are not included in the following example.

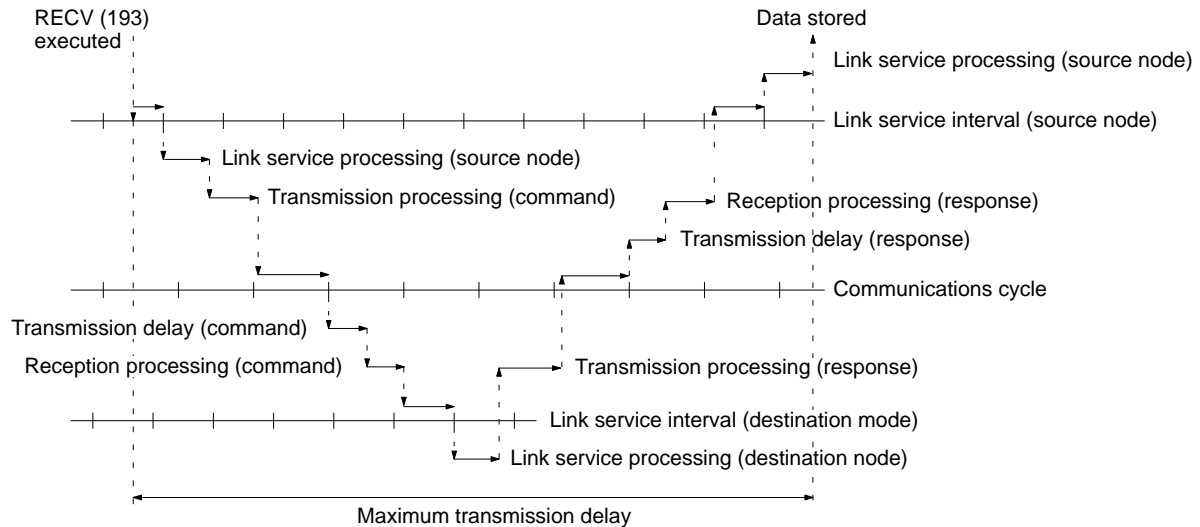

Max. transmission delay = Link servicing interval (source node) + Transmission processing (command) + Communications cycle + Transmission delay (command) + Reception processing (command) + Link servicing interval (destination node) + LINK service processing (destination node) + Transmission processing (response) + Communications cycle + (transmission delay (response) + Reception processing (response) + Link servicing interval (source node) + LINK service processing (source node)).

Link Servicing Interval (Source and Destination Nodes)

Link servicing depends on the execution mode of the PC. The execution modes on the source and destination modes need not be the same.

For synchronous processing, links are serviced once per PC execution cycle. For non-synchronous processing, links are serviced according to the peripheral servicing interval. Refer to the *CV-series PC Operation Manual: Ladder Diagrams* for details.

Link Service Processing (Source and Destination Nodes)

Link service processing is the same as the PC's peripheral servicing and is approximately 1 ms for SYSMAC LINK Units.

Transmission and Reception Processing

Commands: 2 ms

Responses: Number of words transferred x 0.0045 ms + 4 ms

Communications Cycle Time

Coaxial: Max. node address x 0.01 ms + no. of nodes x 0.075 ms + no. of polled units x 0.75 ms + 1.322 ms

Optical: Max. node address x 0.01 ms + no. of nodes x 0.133 ms + no. of polled units x 0.75 ms + 1.322 ms

Transmission Delay

Commands: 0.204 ms

Responses: Number of words transferred x 0.008 ms + 0.204 ms

Note The I/O response time can increase due to noise or restrictions on the number of frames that can be transmitted while the data link is operating.

Example

In this example, the maximum transmission delay is calculated for an instruction receiving 256 words of data in a system with 32 nodes. Network specifics are detailed below:

Max. node address: 32
 Number of nodes: 32
 Source node CPU execution processing: Synchronous
 Destination node CPU execution processing: Non-synchronous
 Number of polled units: 4
 Number of words: 256
 Communications: coaxial cable
 Data link: halted

Delay cause	Maximum delay (ms)
LINK Unit servicing (source node)	PC cycle time
LINK service processing (source node)	1 ms
Transmission processing (command)	2 ms
Communications cycle	$32 \times 0.01 + 32 \times 0.075 + 4 \times 0.75 + 1.322 = 7.042$ ms
Transmission delay (command)	0.204 ms
Reception processing (command)	2 ms
Link servicing interval (destination node)	As required by peripheral device
Link service processing (destination node)	1 ms
Transmission processing (response)	$256 \times 0.0045 + 4 = 5.152$ ms
Transmission delay (response)	$256 \times 0.008 + 0.204 = 2.252$ ms
Reception processing (response)	$256 \times 0.0045 + 4 = 5.152$ ms
Max. transmission delay	PC cycle time (source node) \times 2 + Peripheral servicing time (destination node) + 32.844 ms

7-3 CV-mode Command/Response Format

This section describes the format of the commands and responses used with the CMND(194) instruction via a CV-series SYSMAC LINK Unit. SYSMAC LINK Units support only CV-mode (FINS) commands.

Unless another format is specifically indicated, all commands and responses are in hexadecimal. Commands that are sent to a PC CPU differ from those that are sent to a SYSMAC LINK Unit.

Although SYSMAC CV-series PCs support both C-mode and CV-mode commands, CV-series SYSMAC LINK Units do not support C-mode commands, which are used for data exchanges with SYSMAC C-series PCs.

CV-mode (FINS) Commands

CV-mode commands are used for data exchange between SYSMAC CV-series PCs and other network nodes. Command processing sometimes varies for the same command code depending on the Unit to which the command is being sent, as specified in the unit address of CMND(194).

This manual describes only the commands sent to CV-series CPUs and to CV500-SLK11 and CV500-SLK21 SYSMAC LINK Units. Refer to the operation manuals of the specific Units when sending commands to any other type of Unit.

Command Format

Commands have the following format. This data must be stored beginning at first command word specified as an operand (S) of the CMND(194) instruction.

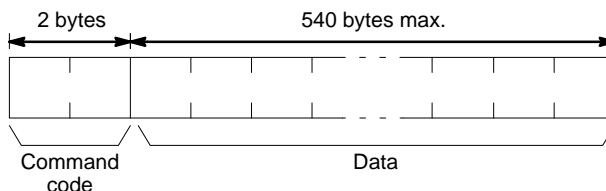
**Response Format**

Responses have the following format and are stored beginning at the first response word specified as an operand (D) of the CMND(194) instruction.

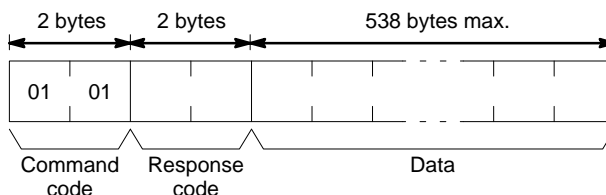

7-4 CV-mode Command Lists

7-4-1 Commands for PCs (CV-mode Commands)

Command code	Name	PC mode				Page
		RUN	MONITOR	DEBUG	PROGRAM	
01	01 MEMORY AREA READ	Valid	Valid	Valid	Valid	p. 84
	02 MEMORY AREA WRITE	Valid	Valid	Valid	Valid	p. 85
	03 MEMORY AREA FILL	Valid	Valid	Valid	Valid	p. 86
	04 MULTIPLE MEMORY AREA READ	Valid	Valid	Valid	Valid	p. 87
	05 MEMORY AREA TRANSFER	Valid	Valid	Valid	Valid	p. 88
02	01 PARAMETER AREA READ	Valid	Valid	Valid	Valid	p. 89
	02 PARAMETER AREA WRITE	Valid	Valid	Valid	Valid	p. 90
	03 PARAMETER AREA CLEAR	Valid	Valid	Valid	Valid	p. 93
03	04 PROGRAM AREA PROTECT	Valid	Valid	Valid	Valid	p. 94
	05 PROGRAM AREA PROTECT CLEAR	Valid	Valid	Valid	Valid	p. 95
	06 PROGRAM AREA READ	Valid	Valid	Valid	Valid	p. 95
	07 PROGRAM AREA WRITE	Not valid	Valid	Valid	Valid	p. 96
	08 PROGRAM AREA CLEAR	Not valid	Not valid	Not valid	Valid	p. 97
04	01 RUN	Valid	Valid	Valid	Valid	p. 97
	02 STOP	Valid	Valid	Valid	Valid	p. 98
05	01 CONTROLLER DATA READ	Valid	Valid	Valid	Valid	p. 98
	02 CONNECTION DATA READ	Valid	Valid	Valid	Valid	p. 100
06	01 CONTROLLER STATUS READ	Valid	Valid	Valid	Valid	p. 100
	20 CYCLE TIME READ	Valid	Valid	Not valid	Not valid	p. 102
07	01 CLOCK READ	Valid	Valid	Valid	Valid	p. 102
	02 CLOCK WRITE	Valid	Valid	Valid	Valid	p. 103
09	20 MESSAGE READ	Valid	Valid	Valid	Valid	p. 103
	MESSAGE CLEAR	Valid	Valid	Valid	Valid	p. 104
	FAL/FALS READ	Valid	Valid	Valid	Valid	p. 105
0C	01 ACCESS RIGHT ACQUIRE	Valid	Valid	Valid	Valid	p. 105
	02 ACCESS RIGHT FORCED ACQUIRE	Valid	Valid	Valid	Valid	p. 106
	03 ACCESS RIGHT RELEASE	Valid	Valid	Valid	Valid	p. 107

Command code		Name	PC mode				Page
			RUN	MONITOR	DEBUG	PROGRAM	
21	01	ERROR CLEAR	Valid	Valid	Valid	Valid	p. 107
	02	ERROR LOG READ	Valid	Valid	Valid	Valid	p. 109
	03	ERROR LOG CLEAR	Valid	Valid	Valid	Valid	p. 109
22	01	FILE NAME READ	Valid	Valid	Valid	Valid	p. 110
	02	SINGLE FILE READ	Valid	Valid	Valid	Valid	p. 111
	03	SINGLE FILE WRITE	Valid	Valid	Valid	Valid	p. 112
	04	MEMORY CARD FORMAT	Valid	Valid	Valid	Valid	p. 113
	05	FILE DELETE	Valid	Valid	Valid	Valid	p. 113
	06	VOLUME LABEL CREATE/DELETE	Valid	Valid	Valid	Valid	p. 114
	07	FILE COPY	Valid	Valid	Valid	Valid	p. 114
	08	FILE NAME CHANGE	Valid	Valid	Valid	Valid	p. 115
	09	FILE DATA CHECK	Valid	Valid	Valid	Valid	p. 115
	0A	MEMORY AREA FILE TRANSFER	Valid	Valid	Valid	Valid	p. 116
	0B	PARAMETER AREA FILE TRANSFER	Valid	Valid	Valid	Valid	p. 117
	0C	PROGRAM AREA FILE TRANSFER	(see note)	Valid	Valid	Valid	p. 119
23	01	FORCED SET/RESET	Not valid	Valid	Valid	Valid	p. 120
	02	FORCED SET/RESET CANCEL	Not valid	Valid	Valid	Valid	p. 120

Note When the PC is in RUN mode, data transfers from files to the program area are not possible, but transfers from the program area to files are possible.

7-4-2 Commands for SYSMAC LINK Units (CV-mode Commands)

Command code		Name	Page
04	01	RUN (see note)	p. 121
	02	STOP (see note)	p. 121
	03	RESET	p. 122
05	01	CONTROLLER DATA READ (see note)	p. 122
06	01	CONTROLLER STATUS READ (see note)	p. 122
	02	NETWORK STATUS READ	p. 124
	03	DATA LINK STATUS READ	p. 126
08	01	LOOP BACK TEST	p. 127
	02	BROADCAST TEST RESULTS READ	p. 127
	03	BROADCAST TEST DATA SEND	p. 128
21	02	ERROR LOG READ (see note)	p. 128
	03	ERROR LOG CLEAR (see note)	p. 129

Note These commands are also sent to the PC.

7-5 Response Codes

A response code consists of two bytes. If a command is completed normally, a response code of 00 00 will be returned. The first two digits of a response code are called the main response code (MRES) and the last two digits are called the sub-response code (SRES). If command execution results in an error, one of the response codes listed in the following table will be returned. Refer to *Section 9 Error Processing* for details.

MRES	Description
00	Normal completion
01	Local node error
02	Destination node error
03	Controller error
04	Not executable
05	Routing error
10	Command format error
11	Parameter error
20	Read not possible
21	Write not possible
22	Not executable in current PC mode
23	No Unit
24	No Unit
25	Unit error
26	Command error
30	Access right error

7-6 Memory Area Designations

The following table gives the addresses that can be used when reading or writing PC data. The *Data area address* column gives the normal addresses used in the PC program. The *Address used in communications* column are the addresses used in CV-mode commands and responses. These addresses are combined with the memory area codes to specify PC memory locations. These addresses are not the same as the actual memory addresses of the data.

The *No. of bytes* column specifies the number of bytes to read or write data for that area. The number of bytes varies for the same area depending on the memory area code.

Data specified as “with forced status” or in the “forced status area” will indicate whether bits have been force-set or force-reset from a Peripheral Device.

Memory area	Data	Data area address	Address used in communications	Memory area code	No. of bytes	
CIO, TR, CPU Bus Link, and Auxiliary Areas	Bit status	CIO TR G A	000000 to 255515 TR0 to TR7 G00000 to G25515 A00000 to A51115	000000 to 09FB0F 09FF00 to 09FF07 0A0000 to 0AFF0F 0B0000 to 0CFF0F	00	1
	Bit status (with forced status)	CIO G	000000 to 255515 G00000 to G25515	000000 to 09FB0F 0A0000 to 0AFF0F	40	1
	Word contents	CIO TR G A	0000 to 2555 G000 to G255 A000 to A511	000000 to 09FB00 09FF00 0A0000 to 0AFF00 0B0000 to 0CFF00	80	2
	Word contents (with forced status)	CIO G	0000 to 2555 G000 to G255	000000 to 09FB00 0A0000 to 0AFF00	C0	4

Memory area	Data		Data area address	Address used in communications	Memory area code	No. of bytes
Timer Area/ Counter Area	Completion Flag status	TIM CNT	T0000 to T1023 C0000 to C1023	000000 to 03FF00 080000 to 0BFF00	01	1
	Completion Flag status (with forced status)	TIM CNT	T0000 to T1023 C0000 to C1023	000000 to 03FF00 080000 to 0BFF00	41	1
	PV	TIM CNT	T0000 to T1023 C0000 to C1023	000000 to 03FF00 080000 to 0BFF00	81	2
DM Area	Word contents	DM	D00000 to D24575	000000 to 5FFF00	82	2
Transition Area	Flag status	TN	TN0000 to TN1023	000000 to 03FF00	03	1
Step Area	Flag status	ST	ST0000 to ST1023	000000 to 03FF00	04	1
	Status		NA	000000 to 0FFF00	44	1
	Step timer PV		NA	000000 to 0FFF00	84	2
Forced Status	Bit status	CIO G	000000 to 255515 G00000 to G25515	000000 to 09FB0F 0A0000 to 0AFF0F	05	1
	Word contents	CIO G	0000 to 2555 G000 to G255	000000 to 09FB00 0A0000 to 0AFF00	85	2
Expansion DM Area	Word contents	Banks 0 to 7	E00000 to E32765 to E00000 to E32765	000000 to 7FFD00 to 000000 to 7FFD00	90 to 97	2
		Current bank	E00000 to E32765	000000 to 7FFD00	98	2
Action Area	Flag status		NA	000000 to 1FFF00	1B	1
Register Area	Register contents	IR DR	IR0 to IR2 DR0 to DR2	000000 to 000200 000300 to 000500	9C	2
	Expansion DM current bank		NA	000600		2
Interrupt Area	Unit interrupt source		NA	000100	DD	4
	Scheduled interrupt interval		NA	000200		4

Word/Bit Addresses

Each word/bit address specifies a specific bit or word. The rightmost two digits of the address specify bit 00 to 15 (or 00 if not required), and leftmost four digits specify the word address.

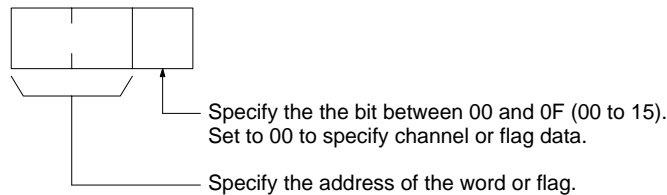

To obtain the corresponding address of the desired word or bit, add the data area word address (hexadecimal) to the first address of the range of addresses used for that data area in communications. For example, the address for word G134 is computed as follows:

First address for CPU Bus Link Area; 0A00
 0A00 + 86 (134 in BCD); 0A86

The word address for C134 would thus be 0A8600 (the memory area code would specify this as a word) and the address of bit 12 in C134 would be 0A860C.

Data Configuration

The configuration of the various types of data that can be read or written is shown below. The number of bytes required for each type of data is also given.

- Flag or Bit Status (One Byte)
 - 00: Bit is OFF (0)
 - 01: Bit is ON (1)

- Word Contents, PV (Two Bytes)

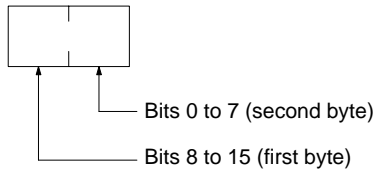

- Current Bank Number of Expansion DM (Two Bytes)

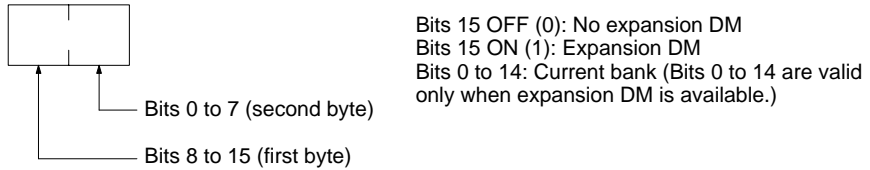

- Scheduled Interrupt Interval

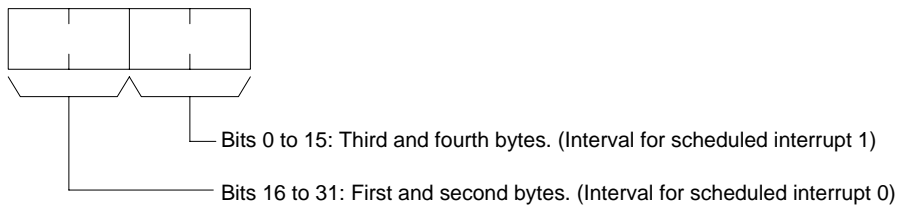

7-7 Volume Labels and File Names

Each volume label or file name consists of 12 bytes as follows:

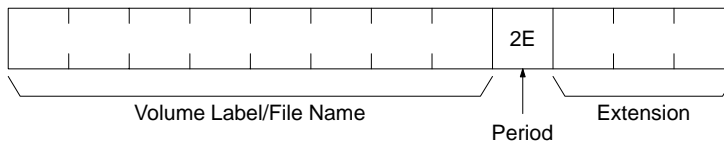

Volume Label/File Name

Each volume label or file name must have eight ASCII characters with or without spaces (ASCII 20). If less than eight letters are used, add spaces to the end of the label/name.

Period

Add a period (ASCII 2E) between the volume label/file name and extension.

Extension

An extension can be added to each volume label/file name so that the files can be classified. Each extension must have three ASCII characters with or without spaces. If less than three letters are used, add spaces to the end of the extension.

7-8 CV-mode Commands for PCs

7-8-1 MEMORY AREA READ

Reads the contents of the specified number of consecutive memory area words starting from the specified word. All words must be in the same memory area (here, all memory areas with the the same memory area code are considered as one area).

Command Block

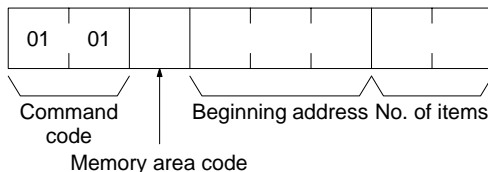

Response Block

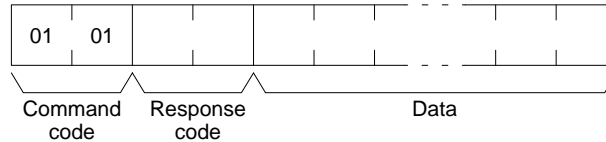

Parameters

Memory area code (command): The data area to read.

Beginning address (command): The address of the first word/bit/flag to read from memory.

No. of items (command): The number of items to be read.

Data (response): The data from the specified words is returned in sequence starting from the beginning address. The required number of bytes in total is calculated as follows:

$$\text{Number of bytes required by each item} \times \text{Number of items}$$

Memory Areas

The following data can be read (refer to 7-6 *Memory Area Designations* for PC word/bit address designations):

Memory area	Data	Memory area code	No. of bytes
CIO, TR, CPU Bus Link, and Auxiliary	Bit status	00	1
	Word contents	80	2
Timer/Counter	Completion Flag status	01	1
	PV	81	2
DM	Word contents	82	2
Transition	Flag status	03	1
Step	Flag status	04	1
Forced status	Bit status	05	1
	Word contents	85	2
Expansion DM	Word contents, specified bank	90 to 97 (banks 0 to 7)	2
	Word contents, current bank	98	2
Action	Flag status	1B	1

7-8-2 MEMORY AREA WRITE

Writes data to the specified number of consecutive words starting from the specified word. All words must be in the same memory area (here, all memory areas with the the same memory area code are considered as one area).

- Note**
1. The MEMORY AREA WRITE command can be executed regardless of the PC's operating mode. It is the user's responsibility to program steps to prohibit this command from being executed when the PC is in RUN mode if such protection is necessary. Execute the CONTROLLER STATUS READ command (refer to 7-8-18 *CONTROLLER STATUS READ*) to read the PC's mode.
 2. When data is written to the Timer/Counter PV Area, the Completion Flags will be turned OFF (0).

Command Block

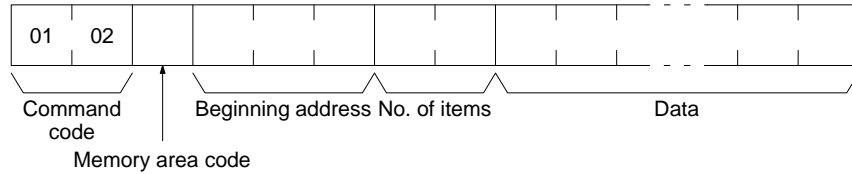

Response Block

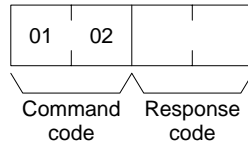

Parameters

Memory area code (command): The data area to write.

Beginning address (command): The first word/value to write.

No. of items (command): The number of items to be written. Set the number of items to 0001 when writing a step timer PV, register value, or interrupt status.

Data (command): The data to be written. The required number of bytes in total is calculated as follows:

$$\text{Number of bytes required by each item} \times \text{Number of items}$$

The following data can be written. For details, refer to 7-6 *Memory Area Designations* for the word/bit address designations.

Memory area	Data	Memory area code	No. of bytes
CIO, TR, CPU Bus Link, and Auxiliary	Word contents	80	2
Timer/Counter	PV	81	2
DM	Word contents	82	2
Step	Step timer PV	84	2
Expansion DM	Word contents, specified bank	90 to 97 (banks 0 to 7)	2
	Word contents, current bank	98	2
Register	Register contents	9C	2
	Current expansion DM bank		
Interrupt status	Scheduled interrupt interval	DD	4

7-8-3 MEMORY AREA FILL

Writes the same data to the specified number of consecutive memory area words. All words must be in the same memory area (here, all memory areas with the the same memory area code are considered as one area).

- Note**
1. The MEMORY AREA FILL command can be executed regardless of the PC's mode. It is the user's responsibility to program steps to prohibit this command from being executed when the PC is in the RUN mode if such protection is necessary. Execute the CONTROLLER STATUS READ command to read the PC's mode. For details, refer to 7-8-18 *CONTROLLER STATUS READ*.
 2. When data is written in the Timer/Counter PV Area, the Completion Flag will be turned OFF (0).

Command Block

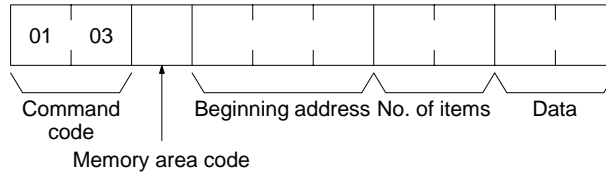

Response Block

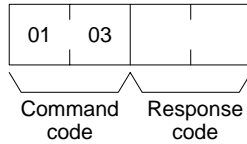

Parameters

Memory area code (command): The data area to write.

Beginning address (command): The first word/values to write.

No. of items (command): The number of items to write.

Data (command): The data to be written to the memory area starting from the Beginning address. The data to be written should consist of two bytes.

The following data can be written. For details, refer to 7-6 *Memory Area Designations* for memory area designations.

Memory area	Data	Memory area code	No. of bytes
CIO, TR, CPU Bus Link, and Auxiliary	Word contents	80	2
Timer/Counter	PV	81	2
DM	Word contents	82	2
Expansion DM	Word contents, specified bank	90 to 97 (banks 0 to 7)	2
	Word contents, current bank	98	2

7-8-4 MULTIPLE MEMORY AREA READ

Reads the contents of the specified number of non-consecutive memory area words, starting from the specified word.

Note If there is an error in the command code or a beginning address, no data will be read.

Command Block

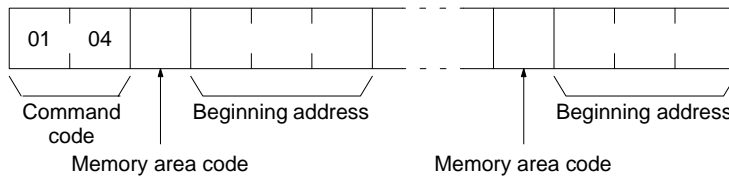

Response Block

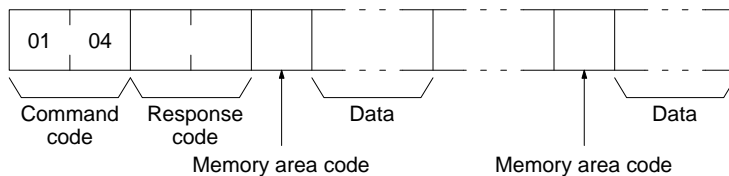

Parameters

Memory area code (command): The data area to read.

Beginning address (command): The first word/bit/flag to read.

Data (response): The data in the specified memory area(s) will be returned in sequence starting from the beginning address.

Memory Areas

The following data can be written. For details, refer to 7-6 *Memory Area Designations* for memory area designations.

Memory area	Data	Memory area code	No. of bytes
CIO, TR, CPU Bus Link, and Auxiliary	Bit status	00	1
	Bit status (with forced status)	40	1
	Word contents	80	2
	Word contents (with forced status)	C0	4
Timer/Counter	Completion Flag status	01	1
	Completion Flag status (with forced status)	41	1
	PV	81	2
DM	Word contents	82	2
Transition	Flag status	03	1
	Flag status (with forced status)	43	1
Step	Flag status	04	1
	Status	44	1
	Step Timer PV	84	2
Forced Status	Bit status	05	1
	Word contents	85	2
Expansion DM	Word contents, specified bank	90 to 97 (banks 0 to 7)	2
	Word contents, current bank	98	2
Action	Flag status	1B	1
Register	Register contents	9C	2
	Current EM bank number		
Interrupt status	Scheduled interrupt interval	DD	4

7-8-5 MEMORY AREA TRANSFER

Copies and transfers the contents of the specified number of consecutive memory area words to the specified memory area. All source words must be in the same area and all designation words must be written to the same area (here, all memory areas with the the same memory area code are considered as one area).

- Note**
1. The MEMORY AREA TRANSFER command can be executed regardless of the PC's mode. It is the user's responsibility to program steps to prohibit this command from being executed when the PC is in the RUN mode if such protection is necessary. Execute the CONTROLLER STATUS READ command to read the PC's mode. For details, refer to 7-8-18 *CONTROLLER STATUS READ*.
 2. When data is written to the Timer/Counter PV Area, the Completion Flags will be turned OFF (0).

Command Block

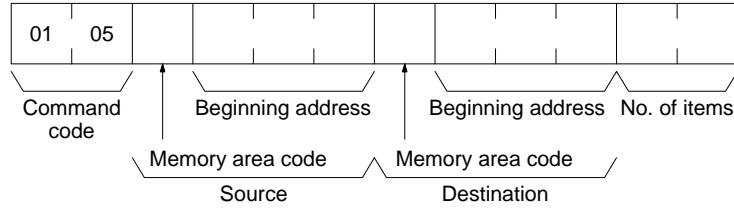

Response Block

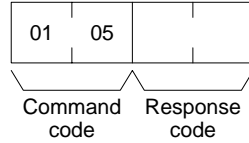

Parameters

Memory area code (command): The data area to transfer from and the data area to transfer to.

Beginning address (command): The first word/value to transfer from and the first word to transfer to.

No. of items (command): The number of items to transfer (each item consists of two bytes).

The following data can be transferred. For details, refer to 7-6 *Memory Area Designations* for memory area designations.

Memory area	Data	Memory area code	No. of bytes
CIO, TR, CPU Bus Link, and Auxiliary	Word contents	80	2
Timer/Counter	PV	81	2
DM	Word contents	82	2
Expansion DM	Word contents, specified bank	90 to 97 (banks 0 to 7)	2
	Word contents, current bank	98	2

7-8-6 PARAMETER AREA READ

Reads the contents of the specified number of consecutive parameter area words starting from the specified word. All words in the specified parameter area must be read at the same time to ensure complete data. A maximum of 266 words can be read with each command. To read larger parameter areas, use multiple commands and specify the beginning word and number of words for each.

Command Block

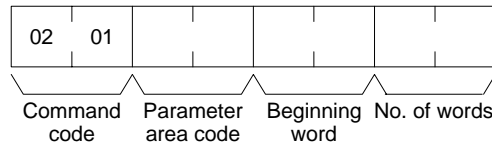

Response Block

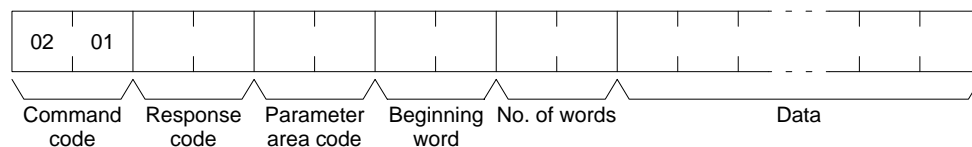

Parameters

Parameter area code (command and response): The parameter area to read.

Beginning word (command and response): The first word to read.

No. of words (command and response): Bits 0 to 14 are used to specify the number of words to be read (each word consists of two bytes). Bit 15 must be OFF (0) in the command block. When the contents in the response block contains the last word of data in the specified parameter area, bit 15 will be ON (1).

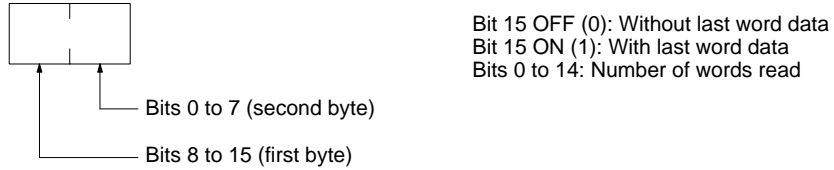

Data (response): The data in the specified parameter area will be returned in sequence starting from the beginning word. The leftmost bits (bits 8 to 15) of each word are read first, followed by the rightmost bits (bits 0 to 7). The required number of bytes in total for each read is calculated as follows:

$$\text{Number of words} \times 2 \text{ (each word consists of two bytes)}$$

Parameter Areas

There are five parameter areas, each of which has consecutive word addresses beginning from 0000. The following data can be read. The word ranges in parentheses show the possible values for the beginning word.

PC Setup		80 10 (0000 to 00FF)	80 01 (0000 to 06BF)	80 00 (0000 to 0FFF)
Peripheral Device settings		80 11 (0000 to 00BF)		
I/O table		80 12 (0000 to 03FF)		
Routing tables*		80 13 (0000 to 01FF)		
CPU Bus Unit settings	Unit No. 0	80 02 (0000 to 083F)		
	.			
	Unit No. 15			

Note *Although the routing tables have a 512-word area (0000 to 01FF0), only a 48-word area (0000 to 003F) of it can read.

7-8-7 PARAMETER AREA WRITE

Writes data to the specified number of consecutive parameter area words starting from the specified word. All words in the specified parameter area must be written at the same time to ensure complete data. A maximum of 266 words can be written with each command. To write larger parameter areas, use multiple commands and specify the beginning word for each.

Data can be written to the I/O table only when the PC is in PROGRAM mode.

Note 1. The PARAMETER AREA WRITE command can be executed regardless of the PC's mode. It is the user's responsibility to program steps to prohibit this command from being executed when the PC is in the RUN mode if such protection is necessary. Execute the CONTROLLER STATUS READ command. to read the PC's mode. For details, refer to 7-8-18 CONTROLLER STATUS READ.

2. If any other device has the access right, nothing will be written to the specified parameter area.
3. If memory is write-protected via the key switch on the front panel of the PC, nothing will be written to the specified parameter area.

Command Block

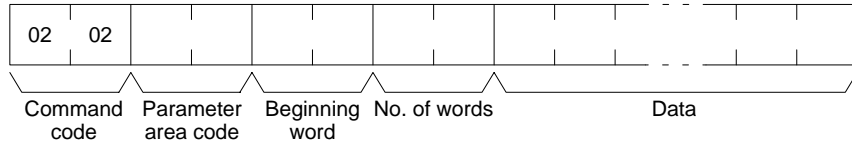

Response Block

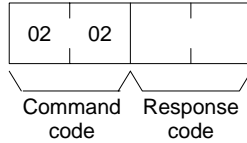

Parameters

Parameter area code (command): The parameter area to write.

Beginning word (command): The first word to write.

No. of words (command): Bits 0 to 14 are used to specify the number of words to be written (each word consists of two bytes). Bit 15 must be ON (1) when data is written to the last word in the specified parameter area or no data will be written. If the number of write words is set to 0000, no words will be written and a normal response code will be returned.

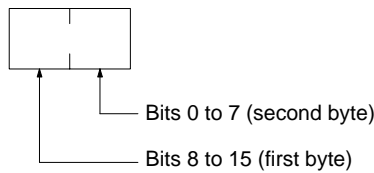

Bit 15 OFF (0): Without last word data to be written.
 Bit 15 ON (1): With last word data to be written.
 Bits 0 to 14: Number of words to be written

Data (command): The data to be written. The leftmost bits (bits 15 to 8) of each word must be specified first, followed by the rightmost bits (bits 7 to 0). The required number of bytes in total for each write can be calculated as follows:

$$\text{No. of words} \times 2 \text{ (each word consists of two bytes)}$$

Parameter Areas

There are five parameter areas, each of which has consecutive word addresses beginning from 0000. The following data can be read. The word ranges in parentheses show the possible values for the beginning word.

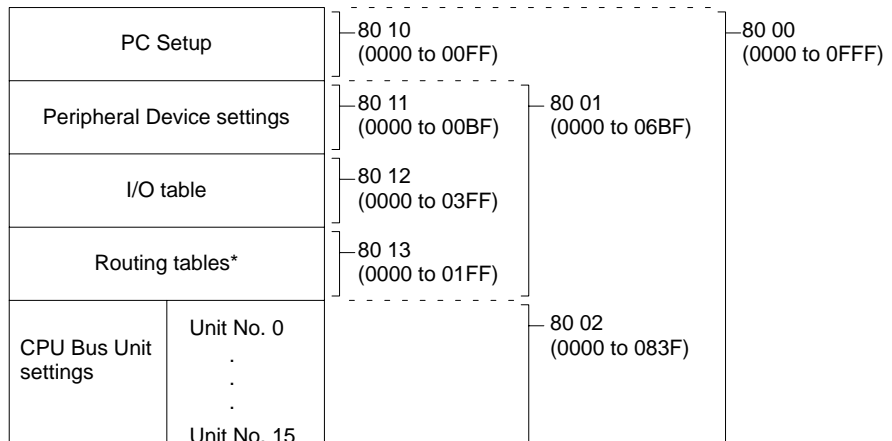

Note *Only a 48-word area (0000 to 003F) of the routing tables is available. The data must be written to the 48-word area in sequence beginning from 0000 or an error will result as the PC automatically does a format check in order to prevent routing errors.

Writing Routing Tables

You can write a routing table directly to the PC's Parameter Area from an IBM PC/AT or compatible computer. After you write the routing table, you must restart the PC so that the routing table that you set will be effective. For details, refer to 6-2 *Routing Tables*.

The configuration of a routing table is as follows:

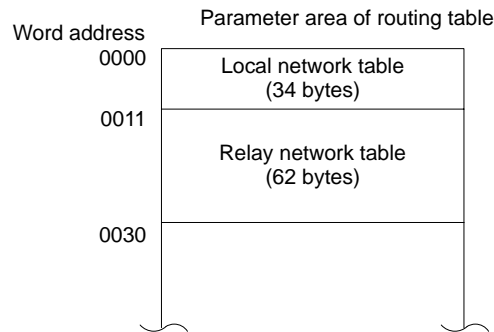

Local Network Table

The following is the configuration of a local network table. A local network table must consist of 34 bytes. If the local network table that you created contains less than 34 bytes, you need to add dummy data to create 34-byte data before you designate the data for the relay network table.

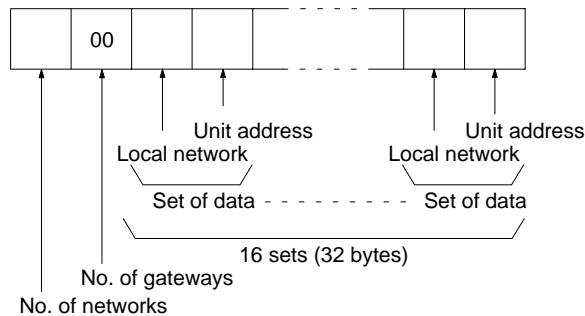

- **Number of Networks**
Designate the number of local networks from 00 to 10 (0 to 16).
- **Number of Gateways**
Set to 00.
- **Local Network**
Designate the address of the local network from 01 to 7F (1 to 127).
- **Unit Address**
Designate the Unit address for SYSMAC NET Link Unit or SYSMAC LINK Unit from 10 to 1F (16 to 31). A Unit address consists of the 10 (hexadecimal) added to the Unit number.

Relay Network Table

The configuration of a relay network table is as follows:

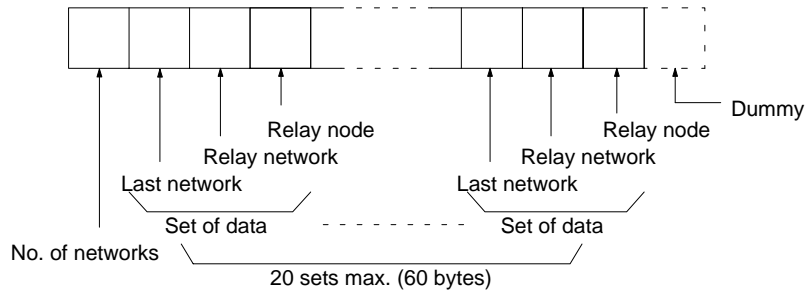

- **Number of Networks**
Designate the number of relay networks from 00 to 14 (0 to 20).
- **Destination Network**
Designate the destination network from 01 to 7D (1 to 127).
- **Relay Network**
Designate the relay network address from 01 to 7F (1 to 127).
- **Relay Node**
Designate the relay node address from 01 to 7E (1 to 126).
- **Dummy**
The number of written data words must always be an even number. If it is an odd number, add a byte of data (any data will do) to make it an even number.

7-8-8 PARAMETER AREA CLEAR

Writes all zeros to the specified number of consecutive parameter area words to clear the previous data. The I/O table can be cleared only when the PC is in PROGRAM mode.

Always clear the entire range of the specified parameter area.

- Note**
1. The PARAMETER AREA CLEAR command can be executed regardless of the PC's mode. It is the user's responsibility to program steps to prohibit this command from being executed when the PC is in the RUN mode if such protection is necessary. Execute the CONTROLLER STATUS READ command to read the PC's mode. For details, refer to 7-8-18 CONTROLLER STATUS READ.
 2. If any other device holds the access right, nothing can be written to the specified parameter area.
 3. If memory is write-protected via the key switch on the front panel of the PC, nothing can be written to the specified parameter area.

Command Block

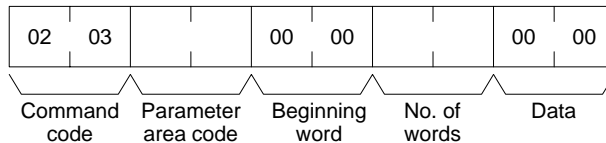

Response Block

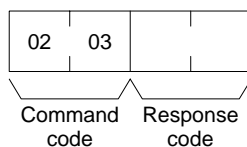

Parameters

Parameter area code (command): The parameter area to clear.

Beginning word (command): Set to 0000.

No. of words (command): The number of words to clear (see diagram below).

Data (command): Set to 0000. The number of word addresses where the data (0000) should be written is specified by the number of words in the command block.

Parameters Areas

The available parameter areas and the number of words in each are as shown below. The number of words in the parentheses is specified as the number of words to clear.

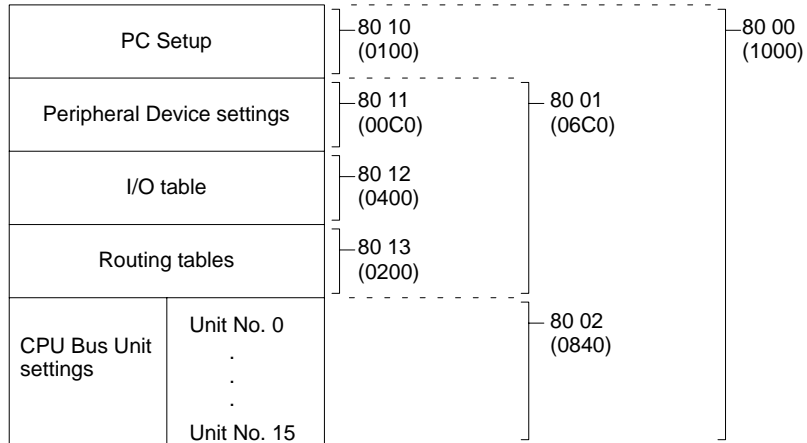

7-8-9 PROGRAM AREA PROTECT

Protects the program by removing all read/write access rights.

- Note**
1. The program cannot be protected if any other device holds the access right.
 2. If memory is write-protected via the key switch on the front panel of the PC, the PROGRAM AREA PROTECT command will not be effective.

Command Block

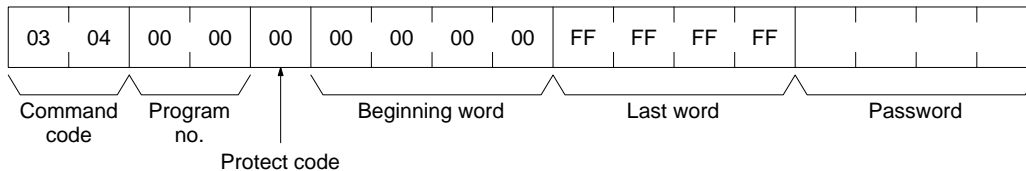

Response Block

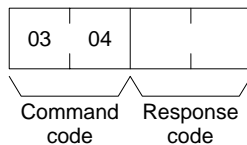

Parameters

The command will be executed normally even if the beginning word and last word are set to values other than those shown above.

Program no. (command): Set to 0000.

Protect code (command): Set to 00.

Beginning word (command): Set to 00000000

Last word (command): Set to FFFFFFFF

Password (command): Set any four ASCII characters. The password is used with the PROGRAM AREA PROTECT CLEAR command (refer to 7-8-10 PROGRAM AREA PROTECT CLEAR).

7-8-10 PROGRAM AREA PROTECT CLEAR

Restores write and read access rights so that data can be written to and read from the program area.

- Note**
1. Protection cannot be cleared if any other device holds the access right.
 2. If memory is write-protected via the key switch on the front panel of the PC, the PROGRAM AREA PROTECT CLEAR command is not effective.

Command Block

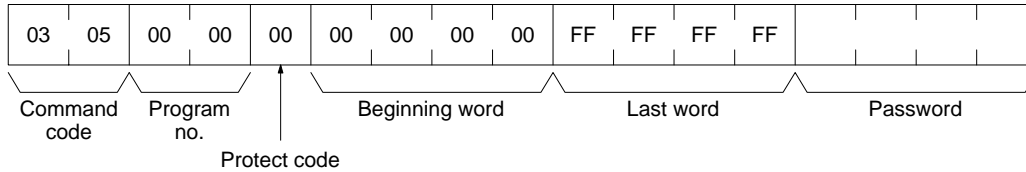

Response Block

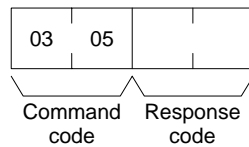

Parameters

The command will be executed normally even if the beginning word and last word are set to values other than those shown above.

Program no. (command): Set to 0000.

Protect code (command): Set to 00.

Beginning word (command): Set to 00000000

Last word (command): Set to FFFFFFFF

Password (command): The password that was set in the PROGRAM AREA PROTECT command.

7-8-11 PROGRAM AREA READ

Reads the contents of the specified number of consecutive program area words starting from the specified word. A maximum of 530 bytes can be read with each command. To read larger amounts of data, use multiple commands and specify the beginning word and number of words for each.

Command Block

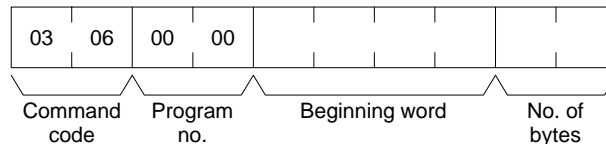

Response Block

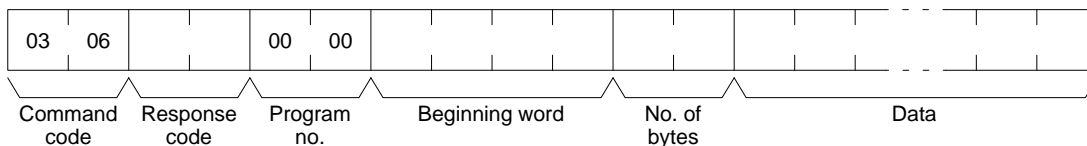

Parameters

Program no. (command and response): Set to 0000.

Beginning word (command and response): Set between 00000E00 and 0000FFFE for the CV500 or CVM1 and between 00000E00 and 0001FFFE for the CV1000 or CV2000. The beginning word must be an even number.

No. of bytes (command and response): The number of bytes in an even number (530 or smaller). Bit 15 must be OFF (0) in the command block. Bit 15 will be ON (1) in the response block when the last word data of the program area is returned.

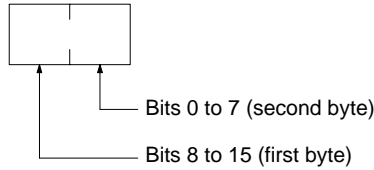

Bit 15 OFF (0): Without last word data
 Bit 15 ON (1): With last word data
 Bits 0 to 14: Number of bytes read

Data (response): The data in the specified program area will be returned in sequence starting from the beginning word.

7-8-12 PROGRAM AREA WRITE

Writes data to the specified number of consecutive program area words starting from the specified word. A maximum of 530 bytes can be written with each command. To write larger amounts of data, use multiple commands and specify the beginning word and number of words for each.

- Note**
1. If memory is write-protected via the key switch on the PC's front panel or by the PROGRAM AREA PROTECT command nothing will be written to the program area. For details, refer to 7-8-9 PROGRAM AREA PROTECT.
 2. The PROGRAM AREA WRITE command can be executed as long as the PC is not in RUN mode. It is the user's responsibility to program steps to prohibit this command from being executed when the PC is in MONITOR or DEBUG mode if such protection is necessary. Execute the CONTROLLER STATUS READ command For details, refer to 7-8-18 CONTROLLER STATUS READ to read the PC's mode.

Command Block

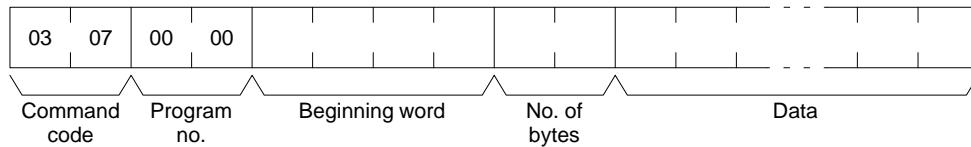

Response Block

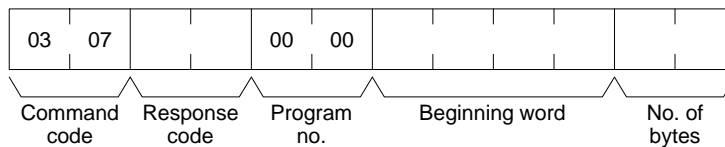

Parameters

Program no. (command and response): Set to 0000.

Beginning word (command and response): Set between 00000E00 and 0000FFFE for the CV500 or CVM1 and between 00000E00 and 0001FFFE for the CV1000 or CV2000. The beginning word must be an even number.

No. of bytes (command and response): The number of bytes in an even number (530 or smaller). Bit 15 must be ON (1) when data is written to the last word in the specified parameter area or no data will be written.

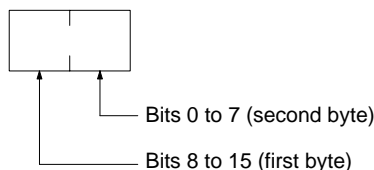

Bit 15 OFF (0): Without last word data
 Bit 15 ON (1): With last word data
 Bits 0 to 14: Number of bytes written

Data (command): The data to be written.

7-8-13 PROGRAM AREA CLEAR

Clears the contents of the program area.

- Note**
1. If memory is write-protected via the key switch on the front panel of the PC, the PROGRAM AREA CLEAR command is not effective.
 2. The PROGRAM AREA CLEAR command will clear the program area even if memory is write-protected by the PROGRAM AREA PROTECT command. For details, refer to 7-8-9 PROGRAM AREA PROTECT.
 3. If any other device holds the access right, the PROGRAM AREA CLEAR command is not effective.

Command Block

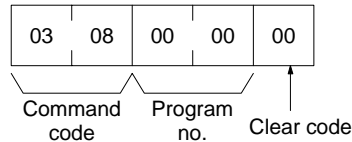

Response Block

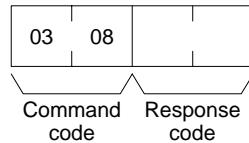

Parameters

Program no. (command): Set to 0000.

Clear code (command): Set to 00.

7-8-14 RUN

Changes the PC to DEBUG, MONITOR, or RUN mode, enabling the PC to execute its program.

- Note** If any other device holds the access right, the PC mode will not be changed.

Command Block

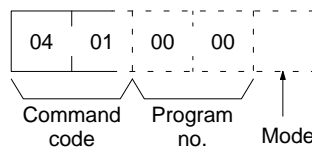

Response Block

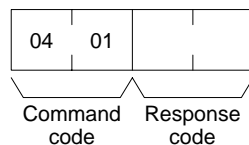

Parameters

Program no. (command): Set to 0000.

Mode (command): As follows:

- 01: DEBUG mode
- 02: MONITOR mode
- 04: RUN mode

- Note** If the mode is not specified, the PC will go to MONITOR mode.

7-8-15 STOP

Changes the PC to PROGRAM mode, stopping program execution.

Note If any other device holds the access right, nothing will be executed.

Command Block

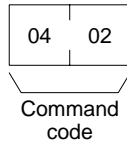

Response Block

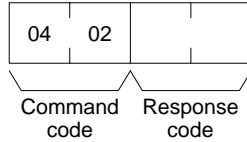

7-8-16 CONTROLLER DATA READ

Reads the following data:

- Controller model and version
- Area data
- Remote I/O data
- CPU Bus Unit configuration
- PC status

Command Block

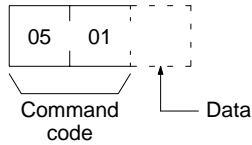

Response Block

The format is as follows if 00 is specified as the data to be read:

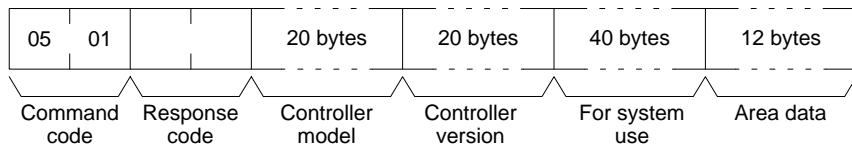

The format is as follows if 01 is specified as the data to be read:

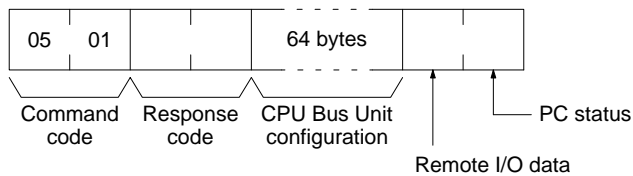

Parameters

Data (command): Specify as follows to read the desired data:

Value	00	01
Data to be read	Controller model Controller version Area data	CPU Bus Unit configuration Remote I/O data PC status

Note If no data is specified, all data will be read consecutively

Controller model and Controller version (response): Both are read in ASCII codes (20 bytes (i.e. 20 ASCII characters) max. each)

For system use (response): Reserved for system use.

Area data (response): As follows:

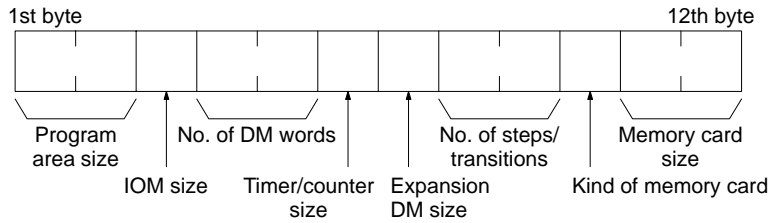

The box below contain additional information to be checked

Item	Meaning	Unit
Program area size	The size of PC Setup and program area	K words (1K words = 1,024 words)
IOM size	The size of the area in which bit/word commands can be used.	K bytes (1K bytes = 1,024 bytes)
No. of DM words	Total words in the DM area	K words
Timer/counter size	Maximum number of timers/counters available	Timers/Counters
Expansion DM size	Banks in the expansion DM area	Banks (1 bank = 32,766 words)
No. of steps/transitions	Maximum number of steps/transitions available	Steps/transitions
Kind of memory card	00: No memory card 01: SPRAM 02: EPROM 03: EEPROM	---
Memory card size	Size of the memory card	K byte (1 word = 2 bytes)

CPU Bus Unit configuration (response): Each CPU Bus Unit has a code assigned to it consisting of two ASCII characters (two bytes). These codes are given in the numerical order according to the unit number of the CPU Bus Units (unit 0 to 15).

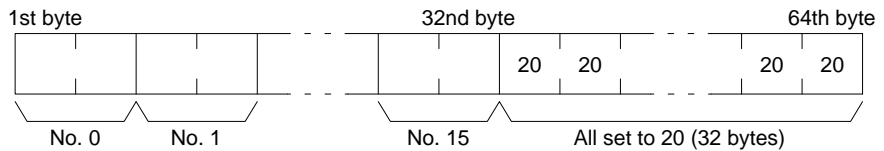

Remote I/O data (response): The number of remote I/O systems (SYSMAC BUS and SYSMAC BUS/2) is returned in two bytes as follows:

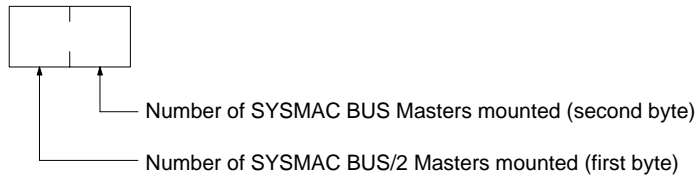

PC status (response): The following single byte (8 bits) is returned:

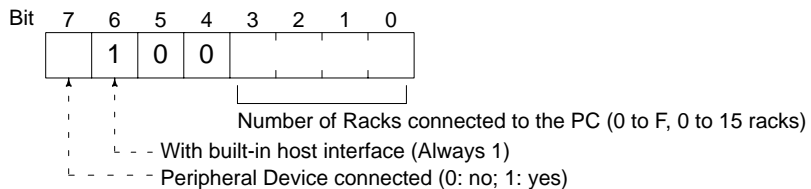

7-8-17 CONNECTION DATA READ

Reads the model number of the specified Units.

Command Block

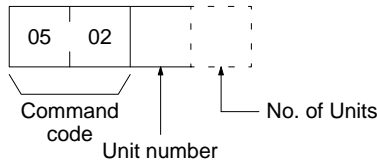

Response Block

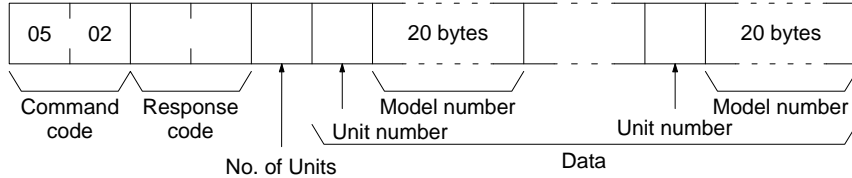

Parameters

Unit number (command and response): The unit number of the first Unit whose model number is to be read. If the specified Unit does not exist, the CONTROLLER DATA READ command is executed from the next Unit.

No. of Units (command): The number of Units for which the model number is to be read. A number between 01 and 19 (hexadecimal) can be specified. If the number of Units is not specified, 19 (25 units) will be used.

No. of Units (response): The number of Units for which a model number is being returned. If bit 7 is ON (1), the model number of the last Unit is returned.

Unit number and model number (response): The Unit number and model number. The model number is provided in up to 20 ASCII characters.

7-8-18 CONTROLLER STATUS READ

Reads the status of the Controller.

Note To read the error log, read the appropriate Auxiliary Area words or execute the ERROR LOG READ command. For details, refer to 7-8-29 ERROR LOG READ.

Command Block

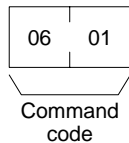

Response Block

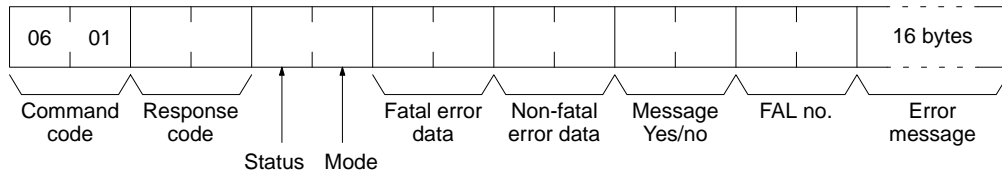

Parameters

Status (response): The operating status of the PC as follows:
00: Stop (program not being executed)
01: Run (program being executed)
80: CPU on standby (the start switch is OFF or the CPU is waiting for a signal from a device such as a SYSMAC BUS/2 Remote I/O Slave Unit).

Mode (response): One of the following PC modes:

- 00:** PROGRAM
- 01:** DEBUG
- 02:** MONITOR
- 04:** RUN

Fatal error data (response): The contents of A401 (for details refer to the CV-series PC Operation Manual: Ladder Diagrams):

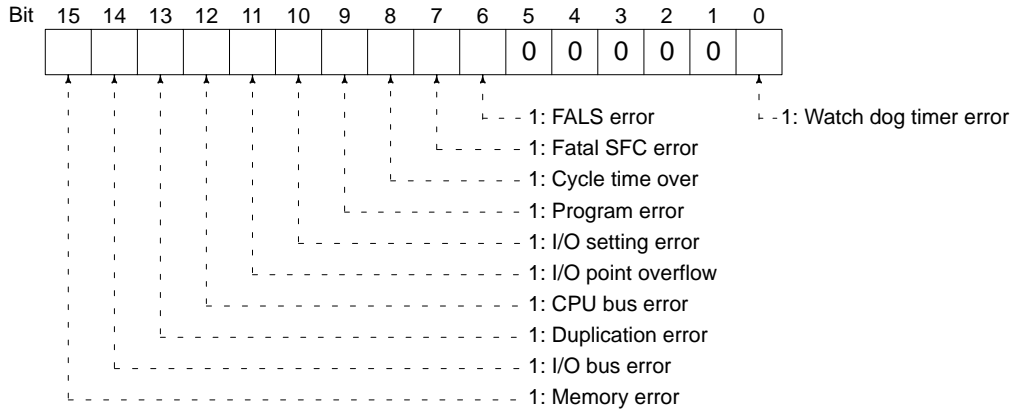

Non-fatal error data (response): The contents of A402 (for details refer to the CV-series PC Operation Manual: Ladder Diagrams):

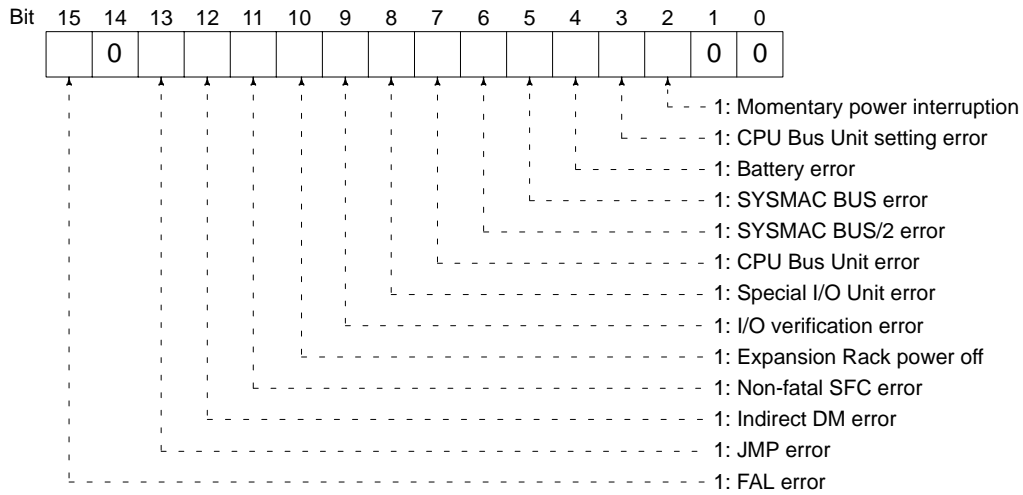

Message yes/no (response): If MSG(195) has been executed, the bit corresponding to the message number will be ON (1) as shown below. To read the messages generated by MSG(195), execute the MESSAGE READ command. For details, refer to 7-8-22 MESSAGE READ.

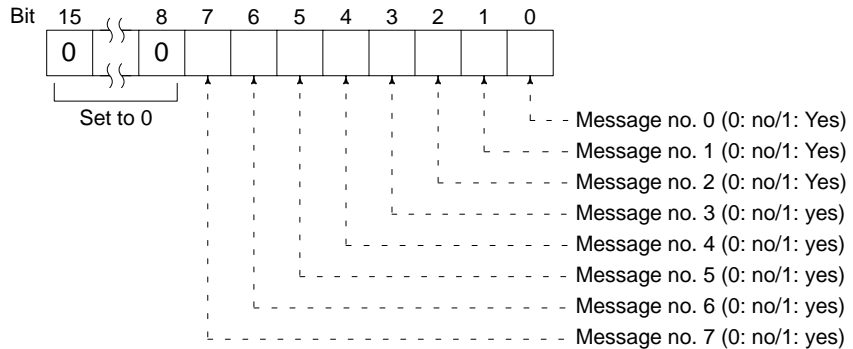

FAL no. (response): The contents of A400 (the highest priority error; for details refer to the *CV-series PC Operation Manual: Ladder Diagrams*).

Error message (response): The error message of the present FAL number. If there is no error, 16 spaces (ASCII 20) will be returned.

7-8-19 CYCLE TIME READ

Initializes the PC's cycle time history or reads the average, max., and min. cycle time.

Command Block

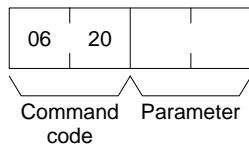

Response Block

The response format is as follows when the parameter is 00 (when initializing):

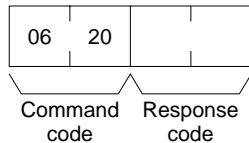

The response format is as follows when the parameter is 01 (when reading):

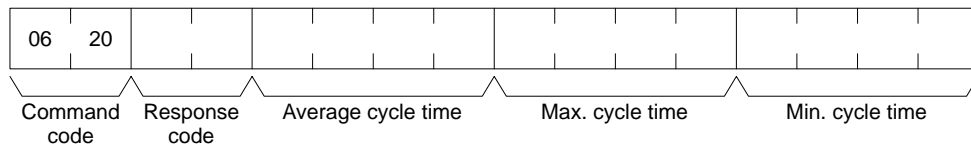

Parameters

Parameter code (command): As follows:

00: Initializes the cycle time.

01: Reads the average, maximum, and minimum cycle time.

Average cycle time, max. cycle time, min. cycle time (response): Each value is expressed in 8-digit BCD in 0.1-ms increments. For example, if 00 00 06 50 is returned, the cycle time is 65 ms.

The average cycle time is obtained as follows:

$$\text{Average cycle time} = (\text{max. cycle time} + \text{min. cycle time})/2$$

7-8-20 CLOCK READ

Reads the clock.

Command Block

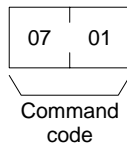

Response Block

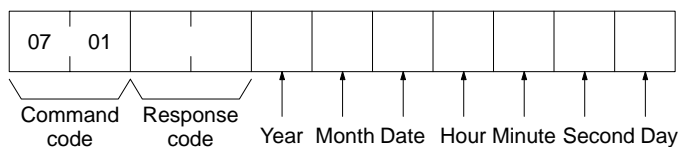

Parameters

Year, month, date, hour, minute, second, day (response): Each value is expressed in BCD.

Year: The rightmost two digits of the year.

Hour: 00 to 23.

Day: As follows:

Value	00	01	02	03	04	05	06
Day	Sun	Mon	Tues	Wed	Thu	Fri	Sat

7-8-21 CLOCK WRITE

Sets the clock.

- Note**
1. The PC automatically checks the range of the specified data. If any portion of the data is incorrect, the clock will not be set.
 2. If any other device holds the access right, the clock will not be set.

Command Block

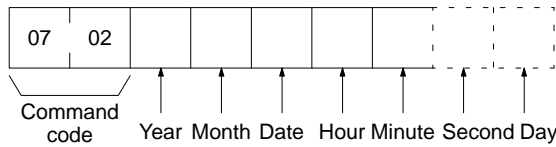

Response Block

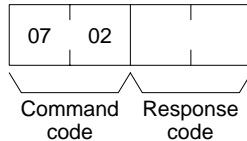

Parameters

Year, month, date, hour, minute, second, day (command): Each specified value is expressed in BCD.

Year: The rightmost two digits of the year.

Hour: Specify 00 to 23.

Day: As follows:

Value	00	01	02	03	04	05	06
Day	Sun	Mon	Tues	Wed	Thu	Fri	Sat

- Note**
1. If the second or day are not specified, 00 will be set as the second and the previous value will be kept for the day.
 2. The PC does not check the day from the date. This means that no error will occur even if the date and day do not agree.

7-8-22 MESSAGE READ

Reads messages generated by MSG(195).

- Note** The MESSAGE READ, MESSAGE CLEAR and FAL/FALS READ commands share the same command code. They are distinguished by bits 14 and 15 of the two-byte parameter following the command code. To read MSG(195) messages, bits 14 and 15 must be OFF (0). For details, refer to 7-8-23 MESSAGE CLEAR and 7-8-24 FAL/FALS READ.

Command Block

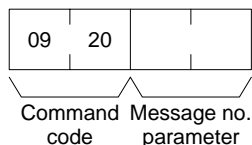

Response Block

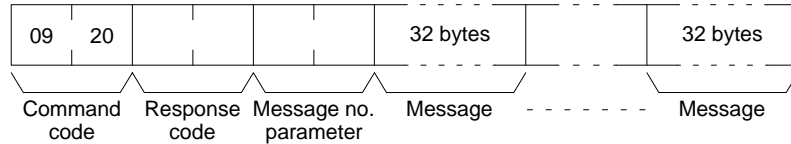

Parameters

Message no. parameter (command and response): In the command block, turn ON (1) the bits of the messages to be read. In the response block, the bits of the messages being returned will be ON (1). If no bits are turned ON in the command block, all bits will be OFF (0) in the response block and no further data will be returned.

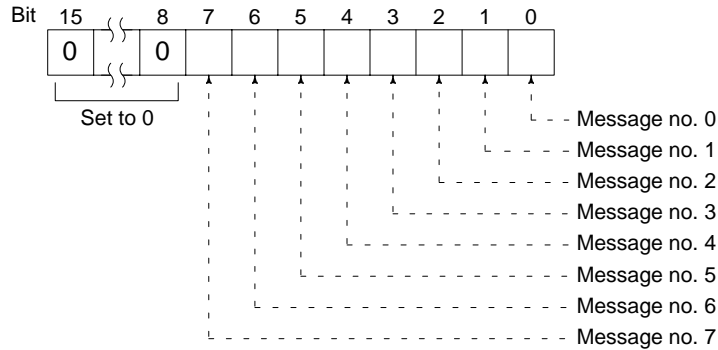

Message (response): Each message is read in the numerical order according to the message number. Each message consists of 32 ASCII characters (32 bytes). The total number of bytes of the messages is calculated as follows:

$$\text{The number of messages} \times 32 \text{ bytes}$$

If no message has been registered for a message number that has been requested, 32 spaces (ASCII 20) will be returned.

7-8-23 MESSAGE CLEAR

Clears messages generated with MSG(195).

- Note**
1. The MESSAGE READ, MESSAGE CLEAR and FAL/FALS READ commands share the same command code. They are distinguished by bits 14 and 15 of the two-byte parameter following the command code. To clear messages, bit 14 must be ON (0) and bit 15 must be OFF (0). For details, refer to 7-8-23 MESSAGE CLEAR and to 7-8-24 FAL/FALS READ.
 2. If any other device holds the access right, messages will not be cleared.

Command Block

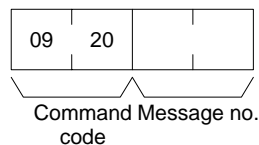

Response Block

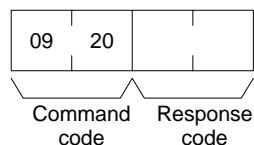

Parameters

Message no. (command): Turn ON the bits of the messages to be cleared.

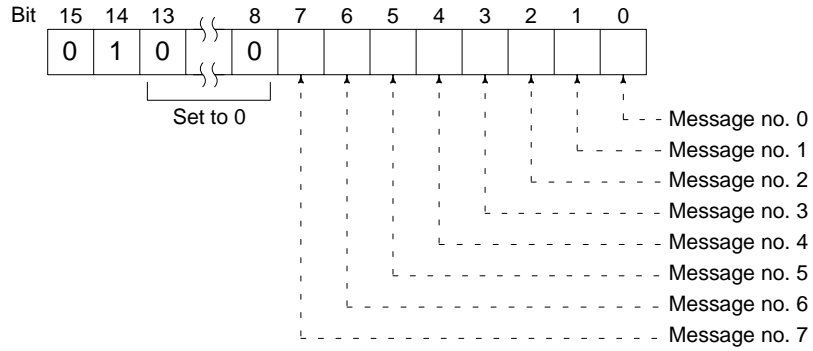

7-8-24 FAL/FALS READ

Reads FAL/FALS messages.

Note The MESSAGE READ, MESSAGE CLEAR, and FAL/FALS READ commands share the same command code. They are distinguished by bits 14 and 15 of the two-byte parameter after the command code. To read FAL/FALS messages, bit 14 must be OFF (0) and bit 15 must be ON (1). For details, refer to 7-8-23 MESSAGE CLEAR, to 7-8-22 MESSAGE READ, and to 7-8-24 FAL/FALS READ.

Command Block

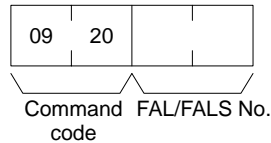

Response Block

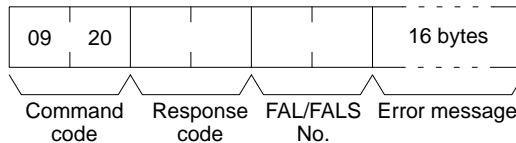

Parameters

FAL/FALS no. (command and response): In the command block, specify in hexadecimal in bits 0 to 13 the FAL or FALS number to be read as shown below. In the response block, the FAL or FALS number is returned.

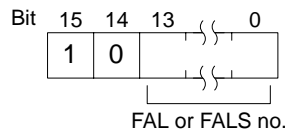

Error message (response): The error message specified in the FAL(006) or FALS(007) instruction. If there is no error, 16 spaces (ASCII 20) will be returned.

7-8-25 ACCESS RIGHT ACQUIRE

Acquires the access right as long as no other device holds it. Execute the ACCESS RIGHT ACQUIRE command when you need to execute commands continuously without being interrupted by other devices. As soon as the execution of the commands has been completed, execute the ACCESS RIGHT RELEASE command to release the access right. If another devices holds the access right, the device will be identified in the response. For details, refer to 7-8-27 Access Right Release).

- Note**
1. If any other device has the access right, the access right cannot be acquired with this command; use the ACCESS RIGHT FORCED ACQUIRE command. For details, refer to 7-8-26 ACCESS RIGHT FORCED ACQUIRE.
 2. The following commands cannot be executed by other devices if the host computer holds the access right. Do not restrict the access right unless necessary.

PARAMETER AREA WRITE	PARAMETER AREA CLEAR
PROGRAM AREA PROTECT	PROGRAM AREA CLEAR
PROGRAM AREA PROTECT CLEAR	
PROGRAM AREA WRITE	RUN
STOP	CLOCK WRITE
MESSAGE CLEAR	ACCESS RIGHT ACQUIRE
ERROR CLEAR	ERROR LOG CLEAR
PARAMETER AREA FILE TRANSFER	
PROGRAM AREA FILE TRANSFER	
FORCED SET/RESET	FORCED SET/RESET CANCEL

Command Block

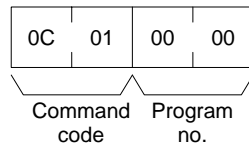

Response Block

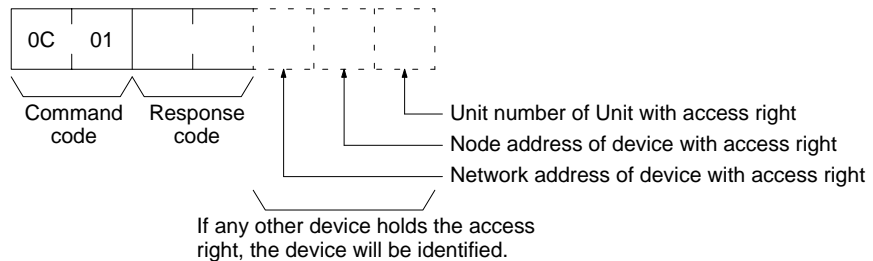

7-8-26 ACCESS RIGHT FORCED ACQUIRE

Acquires the access right even if another device already holds it.

- Note**
1. Even if any other device has the access right, the access right can be acquired with this command and a normal response code will be returned.
 2. The following commands cannot be executed by other devices if the host computer holds the access right. Do not restrict the access right unless necessary.

PARAMETER AREA WRITE	PARAMETER AREA CLEAR
PROGRAM AREA PROTECT	PROGRAM AREA CLEAR
PROGRAM AREA PROTECT CLEAR	
PROGRAM AREA WRITE	RUN
STOP	CLOCK WRITE
MESSAGE CLEAR	ACCESS RIGHT ACQUIRE
ERROR CLEAR	ERROR LOG CLEAR
PARAMETER AREA FILE TRANSFER	
PROGRAM AREA FILE TRANSFER	
FORCED SET/RESET	FORCED SET/RESET CANCEL

3. When the ACCESS RIGHT FORCED ACQUIRE command is executed while any other device has the access right, the access right of the other device will be canceled. If possible, wait until the other device completes the present operation, and then execute the ACCESS RIGHT ACQUIRE command. For details, refer to 7-8-25 ACCESS RIGHT ACQUIRE.
4. The device that has lost the access right is not notified.

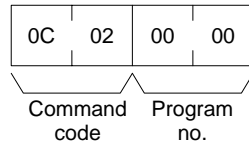
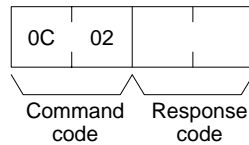
Command Block**Response Block****Parameters**

Program no. (command): Set to 0000.

7-8-27 ACCESS RIGHT RELEASE

Releases the access right regardless of what device holds it. A normal response code will returned even when another device held the access right or when no device held the access right.

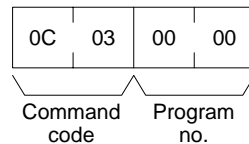
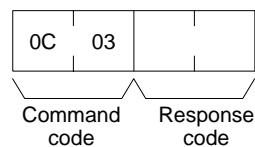
Command Block**Response Block****Parameters**

Program no. (command): Set to 0000.

7-8-28 ERROR CLEAR

Clears errors or error messages from the PC. A normal response will be returned even if the error has not occurred.

Note The cause of the error must be removed before executing the ERROR CLEAR command or the same error will occur again after the ERROR CLEAR command is executed.

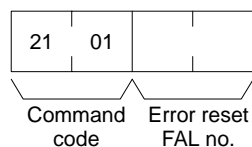
Command Block

Response Block

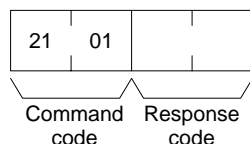

Parameters

Error reset FAL no. (command): The code of the error to be reset.

The following codes can be used regardless of the PC's mode:

Code	Meaning
FFFE	Present error cleared. Resets the highest priority error.
0001	Expansion rack power off
0002	Power interruption error. This error occurs when the CPU power has been interrupted.
00A0 to 00A7	SYSMAC BUS error
00B0 to 00B3	SYSMAC BUS/2 error
00E7	I/O verification error. This error occurs if the I/O table differs from the actual I/O points in the System.
00F4	Non-fatal SFC error. This error occurs when there is an error while the PC is executing an SFC program.
00F6	No EM Area: Specified EM Area does not exist (generated at execution)
00F7	Battery error
00F8	Indirect DM error. This error occurs when a mistake has occurred in indirectly addressing the DM Area.
00F9	JMP error. This error occurs when a jump has been specified without a destination.
0200 to 0215	CPU Bus Unit error (the rightmost two digits are the unit number in BCD of the Unit that has the error). This error occurs if there is a parity error at the time of data transfer between the CPU Bus Unit and CPU or if the CPU Bus Unit has a watchdog timer error.
0400 to 0415	CPU Bus Unit setting error (the rightmost two digits are the unit number in BCD of the Unit that has the error).
4100 to 42FF	FAL(006) executed in the user program.

The following codes can be used only when the PC is in PROGRAM mode:

Code	Meaning
FFFF	All errors cleared.
809F	Cycle time too long
80C0 to 80C7	I/O bus error. This error occurs when there is an error in an I/O bus check or a Unit has been removed or added when power is turned on to the PC.
80E0	I/O setting error. This error occurs if the I/O table differs from actual I/O points in the System.
80E1	I/O points overflow
80E9	Duplication error. This error occurs if the same unit number is assigned more than one Unit or the same word is allocated more than once.
80F0	Program error. This error occurs if a program that exceeds memory capacity is executed.
80F1	Memory error. This error occurs if an error is found in the PC's memory, memory card, or PC Setup during an memory error check.
80F3	SFC definition error. This error occurs if an SFC syntax error has been discovered and the program will not execute.
80FF	System error. This error occurs if the CPU has a watchdog timer error.
8100 to 8115	CPU bus error. The rightmost two digits are the unit number in BCD of the CPU Bus Unit that has the error. This error occurs if an error is discovered during a CPU bus check.
C100 to C2FF	FALS(007) executed.

7-8-29 ERROR LOG READ

Reads the PC's error log.

- Note**
1. When the PC does not have the specified number of records, all the records that have been stored in the PC will be read and an address range overflow error will result.
 2. If the data is too large and exceeds the permissible length of the response block, the part in excess will not be read and a response length overflow error will result.

Command Block

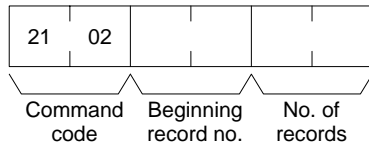

Response Block

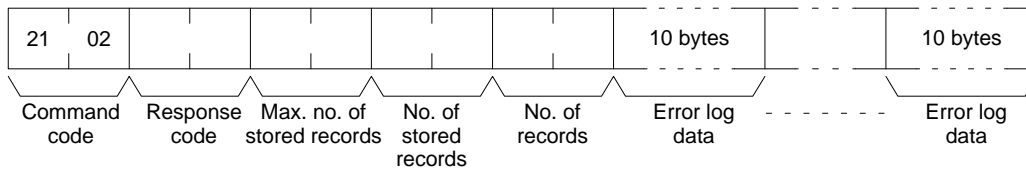

Parameters

Beginning record no. (command): The first record to be read (the first record number is 0000).

Max. no. of stored records (response): The maximum number of records that can be recorded.

No. of stored records (response): The number of records that have been recorded.

No. of records (command and response): The number of records read.

Error log data (response): The specified error log records will be returned in sequence starting from the beginning record number. The total number of bytes required is calculated as follows:

$$\text{Number of records} \times 10 \text{ bytes}$$

The configuration of each error record is as follows:

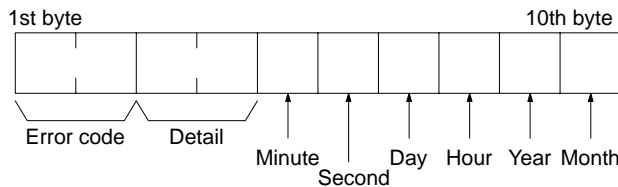

Each data includes the second, minute, hour (0 to 23), date, month, and year (the rightmost two digits) in BCD specifying the time that the error occurred.

7-8-30 ERROR LOG CLEAR

Clears all error log records.

- Note** This command cannot be executed if any other device has the access right.

Command Block

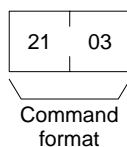

Response Block

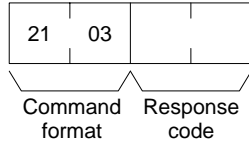

7-8-31 FILE NAME READ

Reads out data on the specified number of files stored in the file device connected to the PC.

Command Block

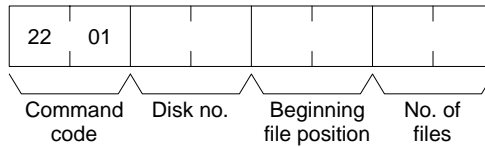

Response Block

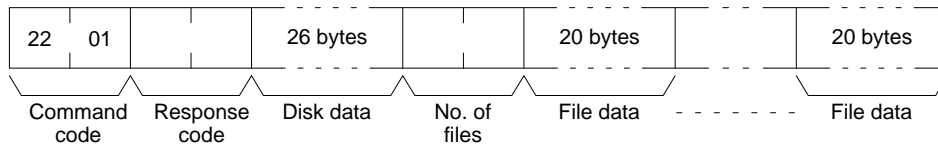

Parameters

Disk no. (command): Set to 0000 for the file device (memory card).

Beginning file position (command): The first file to be read (the first file number is 0000).

No. of files (command): The number of files to be read.

Disk data (response): The data from the file device, the configuration of which is as follows:

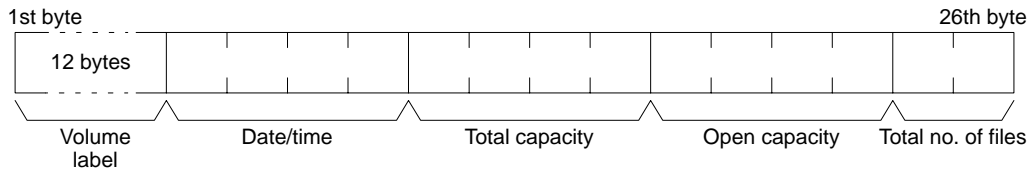

Volume Label

The volume label registered with the file device. For details, refer to 7-7 *Volume Labels and File Names* for the configuration of the volume label. If no volume label has been registered, 20 spaces (ASCII 20) will be returned.

Date/Time

The date and time that the volume label was created (see page 111).

Total Capacity and Open Capacity

The total capacity of the file device and the number of bytes still available (hexadecimal).

Total No. of Files

The number of files recorded in the file device.

No. of files (response): The number of files that have been read. Bit 15 is ON (1) if the last file is included.

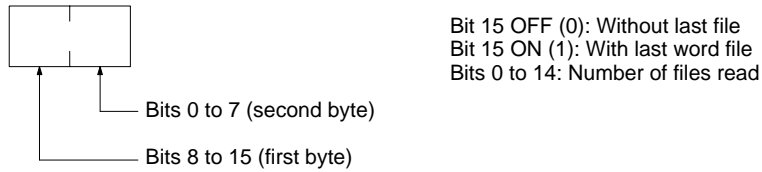

File data (response): Each file data consists of 20 bytes. The specified files will be transmitted in sequence starting from the first file. The total number of bytes required is calculated as follows:

$$\text{Number of read files} \times 20 \text{ bytes}$$

The data for each file data is as follows:

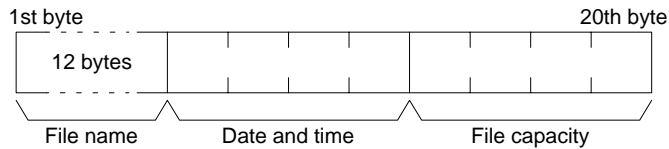

File Name

The name of the file. For details, refer to 7-7 Volume Labels and File Names for the configuration of the file name.

Date/Time

The date and time that the file was created (see below).

File Capacity

The capacity (bytes) of the file.

Date/Time

The configuration of the clock data (four bytes or 32 bits) is as follows:

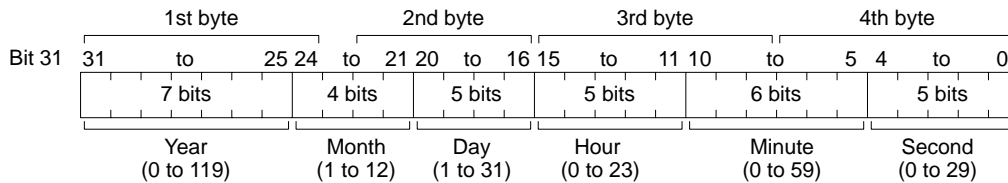

All data values are in BCD.

Year: Add 1980.

Second: Multiply by two.

7-8-32 SINGLE FILE READ

Reads the contents of a file stored in the file device connected to the PC.

Command Block

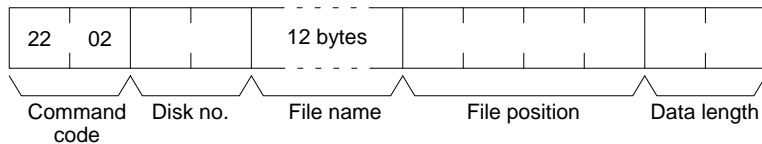

Response Block

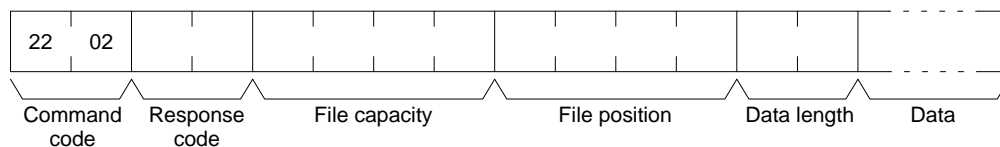

Parameters

Disk no. (command): Set to 0000 for the file device (memory card).

Beginning file name (command): The name of the file to be read. For details, refer to 7-7 *Volume Labels and File Names* for the configuration of the file name.

File position (command and response): The number of bytes from the start of the file from which to start reading (files start at 00000000).

Data length (command and response): The number of bytes of data to read.

File capacity (response): The capacity (bytes) of the file that was read.

Note If the SINGLE FILE READ command is executed for a file with a file capacity of 0 bytes, the data length will be returned as 0000 and no data will be read.

Data (response): The specified data in sequence starting from the specified byte.

7-8-33 SINGLE FILE WRITE

Writes a new file to the file device connected to the PC or appends/overwrites an existing file stored in the file device. Designation can be made to protect existing files if an attempt is made to create a new file of the same name as an existing file. When a new file is written or an existing file is modified, the file will record the clock data of the PC as the date of the file.

Note Writing a new file or modifying an existing file must be done within the capacity of the file device or the SINGLE FILE WRITE command cannot be executed.

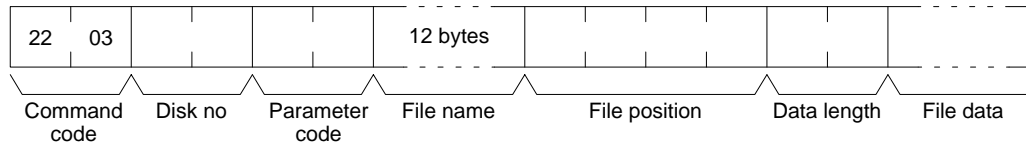
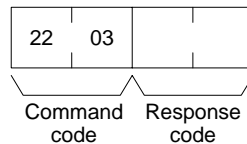
Command Block**Response Block****Parameters**

Disk no. (command): Set to 0000 for the file device (memory card).

Parameter code (command): As follows:

0000: Writes a new file. If a file with the same name already exists, the new file will not be created.

0001: Writes a new file. If a file with the same name already exists, it will be overwritten.

0002: Add data to an existing file.

0003: Overwrite an existing file.

File name (command): The name of the file to be written. For details, refer to 7-8-36 *VOLUME LABEL CREATE/DELETE* for the configuration of the file name.

File position (command): The number of bytes from the start of the file from which to start writing (files start at 00000000). To create a new file or add data to an existing file, specify 00000000 as the file position.

Data length (command and response): The number of bytes to be written.

Note A new file with a file capacity of 0 (no data) will be created if SINGLE FILE WRITE is executed with 0000 as the data length.

File data (response): The data to be written to the file.

7-8-34 MEMORY CARD FORMAT

Formats a memory card. Always execute the MEMORY CARD FORMAT before using a new memory card as a file device.

Note If the MEMORY CARD FORMAT command is executed, all data will be cleared from the memory card.

Command Block

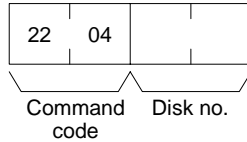

Response Block

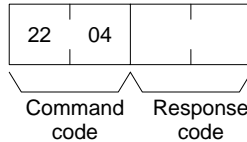

Parameters

Disk no. (command): Set to 0000 for the file device (memory card).

7-8-35 FILE DELETE

Deletes files stored by the file device connected to the PC.

- Note**
1. The specified files will be deleted in sequence. If non-existing file names have been specified, the PC will ignore them and the operation will continue.
 2. If the specified number of files and the number of file names do not coincide, no files will be deleted.

Command Block

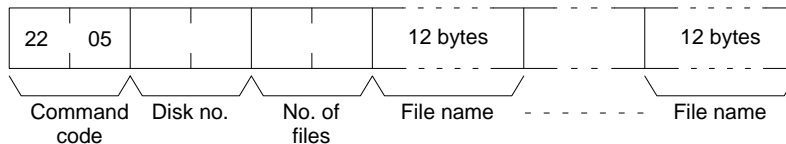

Response Block

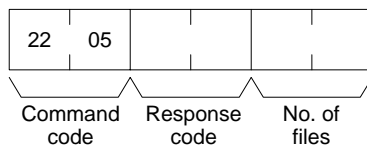

Parameters

Disk no. (command): Set to 0000 for the file device (memory card).

No. of files (command): The number of files to be deleted.

File name (command): The names of the files to be deleted. For details, refer to 7-8-36 VOLUME LABEL CREATE/DELETE for the configuration of the file name.

No. of files (response): The number of files that have been deleted.

7-8-36 VOLUME LABEL CREATE/DELETE

Creates a volume label on the file device connected to the PC or deletes an existing volume label from the file device.

Only one volume label can be created for a single memory card or for all the expansion DM memory banks.

When a volume label is generated, the clock data of the PC will be recorded as the date of the volume label.

Command Block

The command format for creating a volume label is as follows:

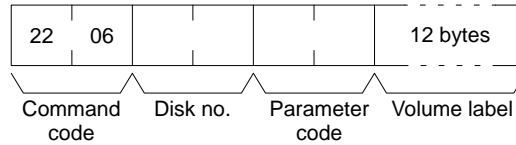

The command format for deleting a volume label is as follows:

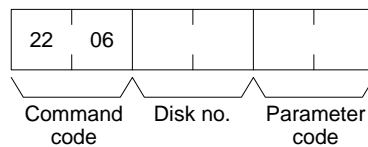

Response Block

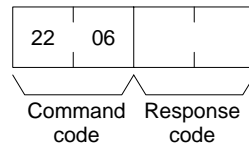

Parameters

Disk no. (command): Set to 0000 for the file device (memory card).

Parameter code (command and response): As follows:

0000: Creates a new volume label. If a label already exists, nothing will be executed.

0001: Creates a volume label. If a label already exists, it will be deleted.

0002: Deletes an existing volume label.

Volume label (command): The volume label to be written. For details, refer to *7-7 Volume Labels and File Names* for the configuration of the volume label.

7-8-37 FILE COPY

Copies a file from one file device to another file device connected to the same PC.

Command Block

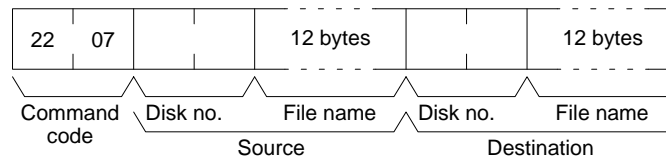

Response Block

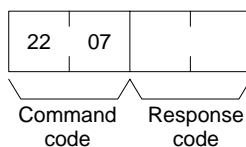

Parameters

Disk no. (command): Set to 0000 for the file devices (memory cards).

File name (command): The file to be copied and a new name for the copied file. For details, refer to *7-7 Volume Labels and File Names* for the configuration of the file name.

- Note**
- a) The file will not be copied if an existing file name is given.
 - b) The copied file is given the same date as the original file.

7-8-38 FILE NAME CHANGE

Changes a file name.

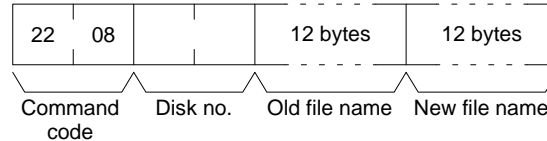
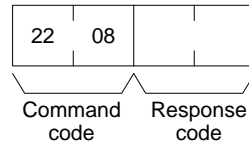
Command Block**Response Block****Parameters**

Disk no. (command): Set to 0000 for the file device (memory cards).

Old and new file names (command): The original file name and a new name for the file. For details, refer to *7-7 Volume Labels and File Names* for the configuration of the file name.

- Note**
- a) The file name will not be changed if an existing file name is given for the new file.
 - b) The new file is given the same date as the original file.

7-8-39 FILE DATA CHECK

Does a data check on a file stored in the file device connected to the PC by confirming the checksum at the beginning of the file.

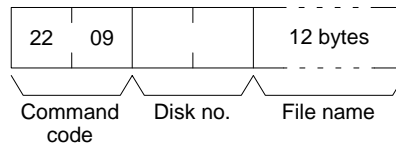
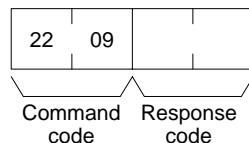
Command Block**Response Block****Parameters**

Disk no. (command): Set to 0000 for the file device (memory cards).

File name (command): The file to be checked. For details, refer to *7-7 Volume Labels and File Names* for the configuration of the file name.

File Data Check

The configuration of a file stored in the file device is as follows:

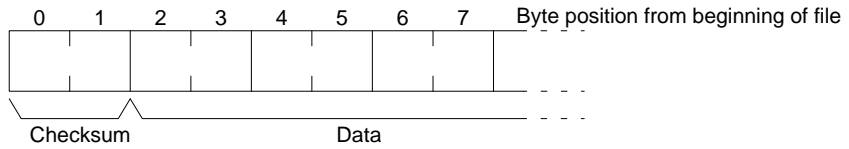

Checksum

The first two bytes of a file are called the checksum, which is the rightmost two bytes resulting from adding all data words (two bytes each). If the number of all bytes is odd, a byte of 00 is added to it so that the number of the number of bytes is even.

Example

- **Data:** 13 3A E4 F3 CC 0B 3C 5F A2
- **Words:** 133A E4F3 CC0B 3C5F A200
- **Total:** 133A + E4F3 + CC0B + 3C5F + A200 = 2A297
- **Checksum:** A2 97

Data

“File data” refers to the data in a file that a file device stores. A file data check is done with the checksum. To complete a file data check, the data words starting from the third byte are added and the result is compared with the checksum. If these values are the same, the file is assumed to contain no errors; if the values differ, a parity/sum check error will result. A file with a capacity of two bytes has a checksum of 0000.

7-8-40 MEMORY AREA FILE TRANSFER

Transfers or compares data between the PC memory areas and the file device connected to the PC. The clock data of the PC upon completion of the MEMORY AREA FILE TRANSFER command will be recorded as the date of the file that has been transferred.

- Note**
1. The checksum is stored at the front (bytes 0 and 1) of the file. Thus file transfer or comparison is effective from the next byte after the checksum.
 2. The MEMORY AREA FILE TRANSFER command can be executed regardless of the PC’s mode. It is the user’s responsibility to program steps to prohibit this command from being executed when the PC is in RUN mode if such protection is necessary. Execute the CONTROLLER STATUS READ command to read the PC’s mode. For details, refer to 7-8-18 CONTROLLER STATUS READ.
 3. If data is written to the Timer/Counter PV Area, the Completion Flags will be turned OFF (0).

Command Block

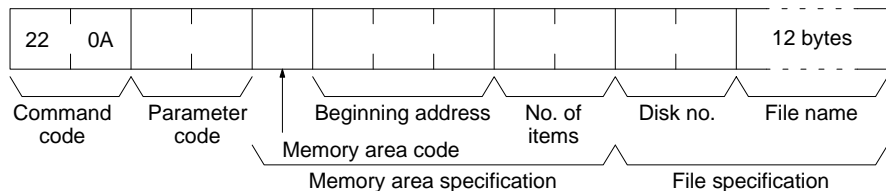

Response Block

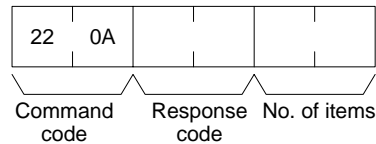

Parameters

Parameter code (command): As follows:

0000: Data transfer from the PC memory area to the file device.

0001: Data transfer from the file device to the PC memory area.

0002: Data compared.

Memory area code (command): The memory area to be used for data transfer or comparison.

Beginning address (command): The first word/value in the memory area to be transferred or compared.

No. of items (command and response): In the command block, the number of items to be transferred or compared. In the response block, the number of items transferred or compared

Disk no. (command): Set to 0000 for the file device (memory cards).

File name (command): The file to be transferred or compared. For details, refer to 7-7 Volume Labels and File Names for the configuration of the file name.

Memory Areas

The following data can be used for transfer or comparison. For details, refer to 7-6 Memory Area Designations for memory area designations.

Memory area	Data	Memory area code	No. of bytes
CIO, TR, CPU Bus Link, and Auxiliary	Word contents	80	2
Timer/Counter	Completion Flag status	01	1
	PV	81	2
DM	Word contents	82	2
Expansion DM	Word contents, specified bank	90 to 97 (banks 0 to 7)	2
	Word contents, current bank	98	2

7-8-41 PARAMETER AREA FILE TRANSFER

Compares or transfers data between the PC's parameter area and the file device connected to the PC. The clock data of the PC upon completion of the PARAMETER AREA FILE TRANSFER command will be recorded as the date of the file that has been transferred.

A file can be transferred to the I/O table only when the PC is in PROGRAM mode.

- Note**
1. The checksum is stored at the front (bytes 0 and 1) of the file. Thus file transfer or comparison is effective from the next byte after the checksum.
 2. The PARAMETER AREA FILE TRANSFER command can be executed regardless of the PC's mode. It is the user's responsibility to program steps to prohibit this command from being executed when the PC is in RUN mode if such protection is necessary. Execute the CONTROLLER STATUS READ command to read the PC's mode. For details, refer to 7-8-18 CONTROLLER STATUS READ.
 3. This command cannot be executed if any other device holds the access right or when memory is write-protected via the key switch on the front panel of the PC.

Command Block

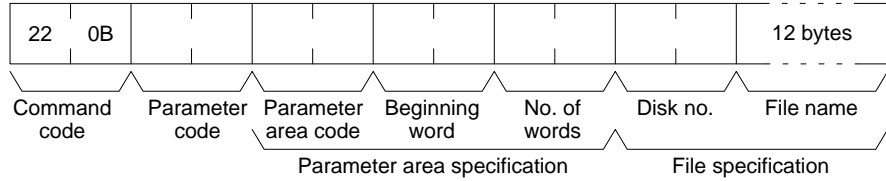

Response Block

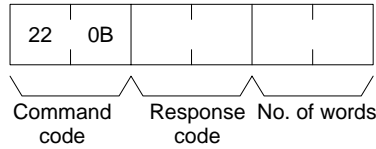

Parameters

Parameter code (command): As follows:

0000: Data transfer from the PC's parameter area to the file device.

0001: Data transfer from the file device to the PC's parameter area.

0002: Data compared.

Parameter area code (command): The parameter area to be used for data transfer or comparison.

Beginning word (command): The first word in the parameter area to be transferred or compared. Each parameter area has consecutive word addresses beginning at 0000 (see below).

No. of words (command and response): In the command block, the number of data words to be transferred or compared. In the response block, the number of words transferred or compared

Note If 0000 is specified as the number of items, no data will be transferred or compared and a normal response code will be returned.

Disk no. (command): Set to 0000 for the file device (memory cards).

File name (command): The file to be transferred or compared. For details, refer to 7-7 *Volume Labels and File Names* for the configuration of the file name.

Parameter Areas

The following shows the parameter areas and the words that can be specified. The word ranges in parentheses show the possible values for the beginning word.

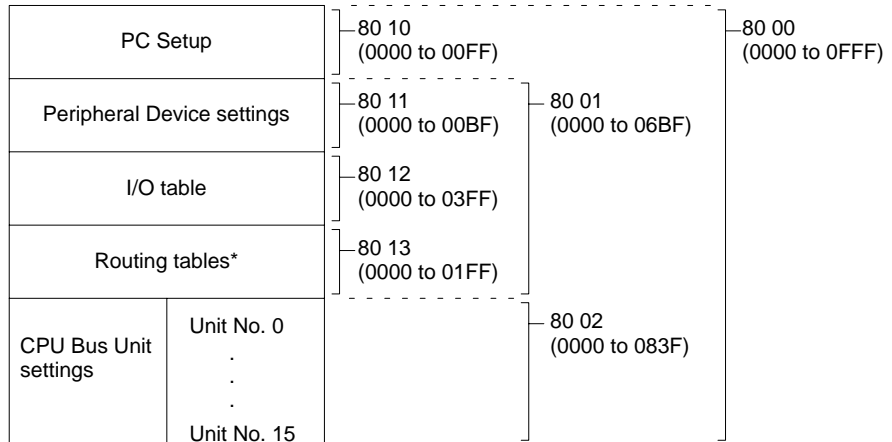

Note *Although the routing tables have a 512-word area (0000 to 01FF0), only a 48-word area (0000 to 003F) of it can read/written.

7-8-42 PROGRAM AREA FILE TRANSFER

Compares or transfers data between the PC's program area and the file device connected to the PC. The clock data of the PC upon completion of the PROGRAM AREA FILE TRANSFER command will be recorded as the date of the file that has been transferred.

- Note**
1. The checksum is stored at the front (bytes 0 and 1) of the file. Thus file transfer or comparison is effective from the next byte after the checksum.
 2. This command cannot be executed when the access right is held by any other device or when the PC is write-protected by the key switch on the front panel.
 3. The PROGRAM AREA FILE TRANSFER command cannot be executed when the PC is in the RUN mode.

Command Block

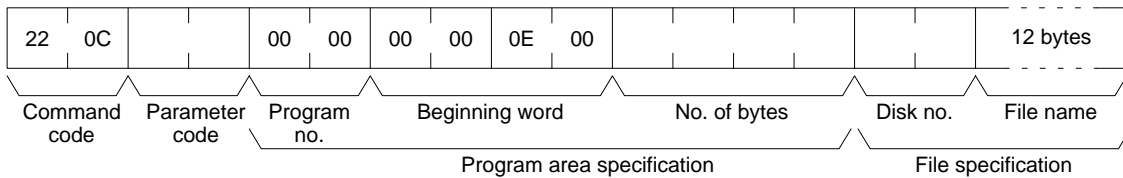

Response Block

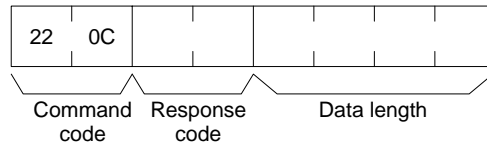

Parameters

Parameter code (command): As follows:

0000: Data transferred from the program area to the file device.

0001: Data transferred from the file device to the program area.

0002: Data compared.

Program no. and beginning word (command): As follows:

0000: Program number

0000E00: Beginning word

No. of bytes (command): The number of data bytes to be transferred or compared as follows:

0000F1FE: CV500 or CVM1

0001F1FE: CV1000 or CV2000

Note If 00000000 is specified as the number of transfer data bytes, no file transfer or comparison will be performed and a normal response code will be read.

Disk no. (command): Set to 0000 for the file device (memory card).

File name (command): The file to be transferred or compared. For details, refer to 7-7 Volume Labels and File Names for the configuration of the file name.

Data length (response): The number of bytes that have been transferred or compared.

7-8-43 FORCED SET/RESET

Force-sets (ON) or force-resets (OFF) bits/flags or releases force-set status. Bits/flags that are forced ON or OFF will remain ON or OFF and cannot be written to until the forced status is released.

Note This command cannot be used to release the status of Completion Flags for timers or counters. Use the FORCE SET/RESET CANCEL command. For details, refer to 7-8-44 FORCED SET/RESET CANCEL.

Command Block

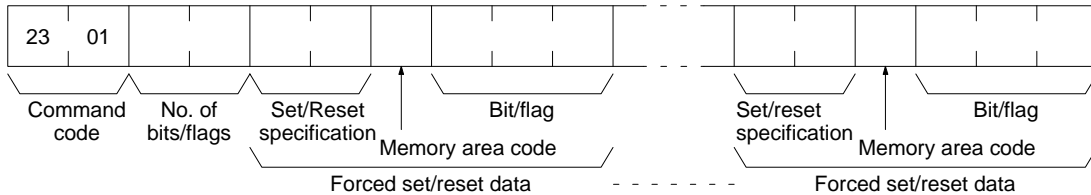

Response Block

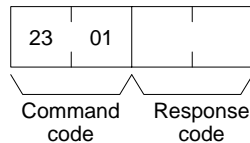

Parameters

No. of bits/flags (command): The number of bits/flags to be controlled.

Set/Reset specification (command): The action to be taken for each bit/flag

Value	Name
0000	Force-reset (OFF)
0001	Force-set (ON)
8000	Forced status released and bit turned OFF (0)
8001	Forced status released and bit turned ON (1)
FFFF	Forced status released

Memory area code (command): The memory area of the bit or flag to be controlled.

Bit/Flag (command): The bit or flag to be controlled.

Memory Areas

The bits (flags) in the following memory areas can be forced set/reset or released. Refer to 7-6 Memory Area Designations for memory area designations.

Memory area	Data	Memory area code
CIO, TR, and CPU Bus Link (see note)	Bits status	00
Timer/Counter	Completion Flag status	01
Transition	Flag status	03

Note FORCED SET/RESET cannot be used for the Auxiliary Area.

7-8-44 FORCED SET/RESET CANCEL

Cancels all bits (flags) that have been forced ON or forced OFF.

Command Block

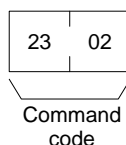

Response Block

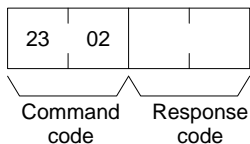

Note The bits (flags) in the following memory areas can be forced set or forced reset.

Memory area	Data	Memory code
CIO, TR, CPU Bus Link, and Auxiliary	Bits status	00
Timer/Counter	Completion Flag status	01
Transition	Flag status	03

7-9 CV-mode Commands for SYSMAC LINK Units

7-9-1 DATA LINK START

Activates data links in the SYSMAC LINK Network.

This command will be completed normally when link words are allocated automatically or via data link tables only.

Command Block

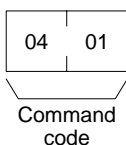

Response Block

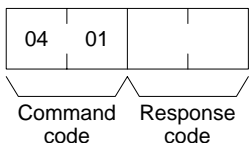

7-9-2 DATA LINK HALT

Stops data links in the SYSMAC LINK Network.

This command will be completed normally when the data link is in operation. If the data link is not in operation, an error will occur.

Command Block

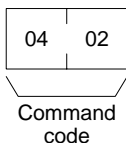

Response Block

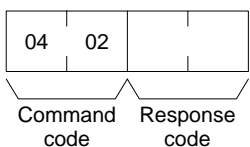

7-9-3 RESET

Resets the SYSMAC LINK Unit.

No response is returned when this command is executed.

Command Block

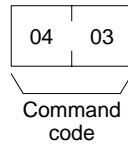

7-9-4 CONTROLLER DATA READ

Reads the following data:

- PC model and version
- Cable type
- Node address
- Common RAM size

Command Block

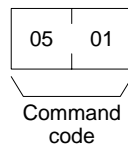

Response Block

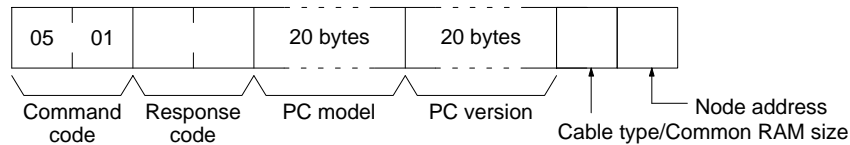

Parameters

PC model and version (response):

Both are read in ASCII codes (20 bytes (i.e. 20 ASCII characters) max. each). If the model or version requires less than 20 characters, the remaining bytes will be filled with spaces (ASCII code 20).

Cable type and Common RAM Size:

Bit 7 will be ON if the SYSMAC LINK Network is using optical fiber cable; OFF if it is using coaxial cable. Bit 00 to 02 will be 011 indicating that the common RAM is 8 Kbytes. The common RAM is the buffer for the communications controller.

Node Address:

The node address of the SYSMAC LINK Unit from 01 to 3E (1 to 62).

7-9-5 CONTROLLER STATUS READ

Reads the status of the PC.

Command Block

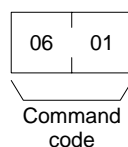

Response Block

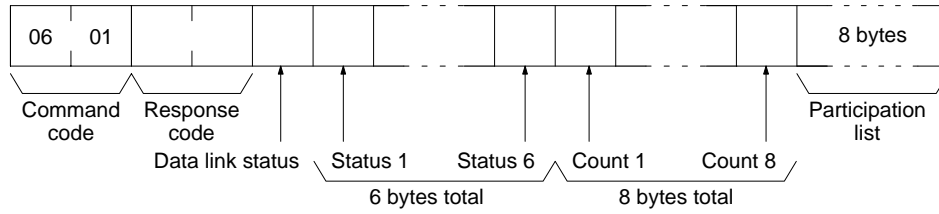

Parameters

Status (response): The operating status of the data links as follows:

00: Stopped

01: Active

Status 1 (response): Communications test status as follows:

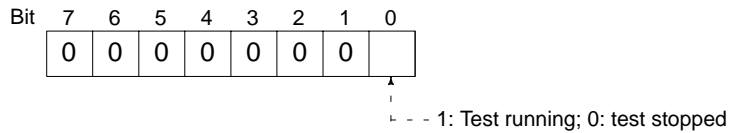

Status 2 (response): Line status as follows:

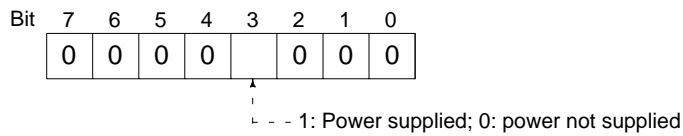

Status 3 (response): Error status as follows:

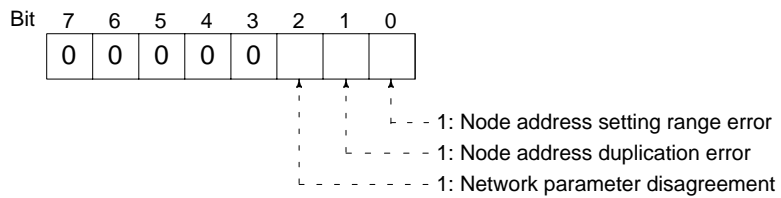

Note The registered network parameters are compared to the actually network parameters upon power application the first time a Unit joins the network. If the parameters do not agree, bit 2, above, will be turned ON, but the system will not stop (the actual network parameters will automatically be registered).

Status 4 (response): The cause of communications controller errors as follows:

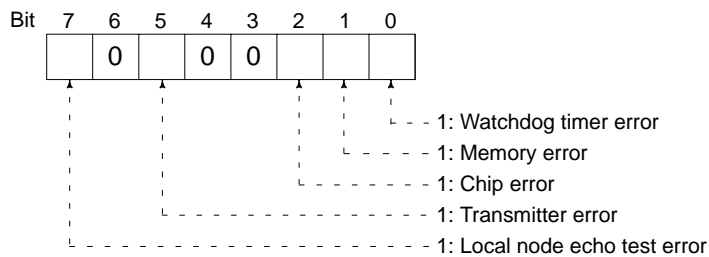

Status 5 (response): Backup status as follows:

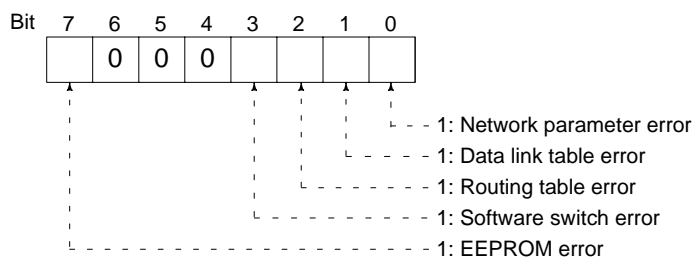

Status 6 (response): Error log status as follows:

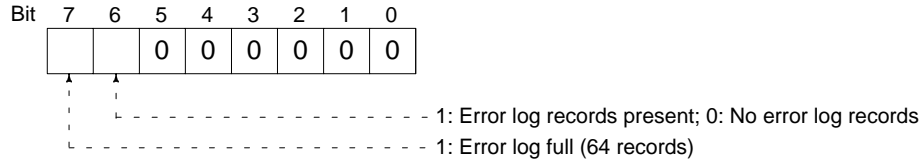

Counts 1 through 8 (response):

Each of the following bytes provides two hexadecimal digits giving the total number of occurrences of the following items since power was turned on. These counters will count to 255 and then remain there until power is turned off again.

- Count : Number of CRC errors
- Count : Number of times token has been resent
- Count : Number of times token has been passed
- Count : Number of token time-outs
- Count : Number of polling time-outs
- Count : Number of time polling unit has changed
- Count : Number of time participating Units have changed
- Count : Number of times communications controller transmit/receive operation has stopped.

Participation List (response):

Bits in the last eight bytes of the response are turned ON to indicate when a node is participating in the SYSMAC LINK network. The bit turned ON for each node address is shown in the following illustration. Bits given as “-” are always zero.

Bit	7	6	5	4	3	2	1	0
Byte 1	8	7	6	5	4	3	2	1
Byte 2	16	15	14	13	12	11	10	9
Byte 3	24	23	22	21	20	19	18	17
Byte 4	32	31	30	29	28	27	26	25
Byte 5	40	39	38	37	36	35	34	33
Byte 6	48	47	46	45	44	43	42	41
Byte 7	56	55	54	53	52	51	50	49
Byte 8	-	-	62	61	60	59	58	57

7-9-6 NETWORK STATUS READ

Reads the status of the SYSMAC LINK Network.

Command Block

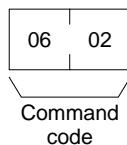

Response Block

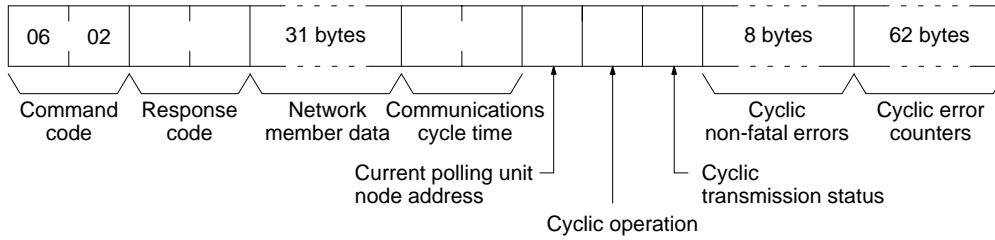

Parameters

Network member data (response): Four bits are allocated to each node address to provide information on the status of nodes in the network as shown below. The function of each of the 4 bits is shown in the diagram following the table.

Byte	Bits 4 to 7	Bits 0 to 3
Byte 1	Node address 2	Node address 1
Byte 2	Node address 4	Node address 3
Byte 3	Node address 6	Node address 5
⋮	⋮	⋮
Byte 31	Node address 62	Node address 61

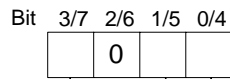

- 1: In network (0: Not in network)
- 1: Exited because of an error.* (0: Normal exit)
- 1: Unit does not respond to polling.

Note *Bit 1/5 is used to indicate why the node is not in the network when bit 0/4 is OFF.

Communications cycle time (response): The actual communications cycle time is provided here in 4-digit hexadecimal in increments of 100 μs.

Current polling unit node address (response): The node address of the unit that currently is the polling unit.

Cyclic operation (response): Indicates the current status of cyclic operation, as follows:

- 00:** Stopped
- 01:** Active

Cyclic transmission status (response): Indicates the current status of cyclic transmission, as follows:

- 00:** No transmission
- 01:** Transmission

Cyclic non-fatal errors (response): These eight bytes indicate nodes in which non-fatal errors occurred in cyclic transmission. When a bit in the following matrix is ON, a non-fatal error occurred in the corresponding node. Bit 0 of the first byte and bit 7 of the eighth byte are always OFF.

Bit	7	6	5	4	3	2	1	0
First byte	7	6	5	4	3	2	1	–
Second byte	15	14	13	12	11	10	9	8
Third byte	23	22	21	20	19	18	17	16
Fourth byte	31	30	29	28	27	26	25	24
Fifth byte	39	38	37	36	35	34	33	32
Sixth byte	47	46	45	44	43	42	41	40
Seventh byte	55	54	53	52	51	50	49	48
Eighth byte	–	62	61	60	59	58	57	56

Cyclic error counters (response): One of these 62 bytes is allocated to each node to indicate how many cyclic errors occurred since start-up. The first byte is allocated to node address 1, the second to node address 2, etc. Each number is 2-digit hexadecimal, so 00 to FF (0 to 255 decimal) errors can be recorded for each node. If more than 255 errors occur, the number will remain at 255.

7-9-7 DATA LINK STATUS READ

Reads the status of the data link.

The various data link status information described here will not be updated while the data link is halted.

Command Block

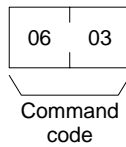

Response Block

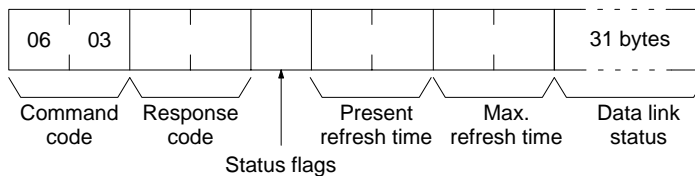

Parameters

Status flags (response): This byte contains flags providing information on overall data link status, as follows:

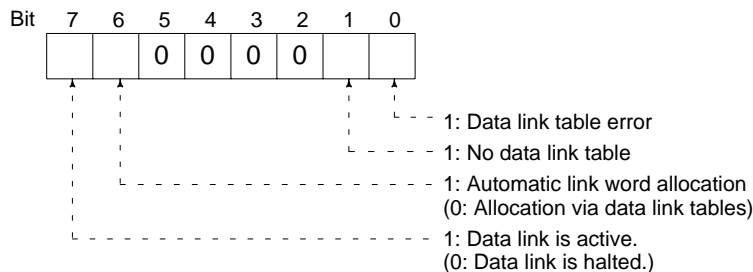

Present and Max. refresh time (response): The present and maximum data link refresh times in 4-digit hexadecimal in increments of 1 ms. The range is 0005 to 00FF (5 to 255 ms, in decimal).

Data link status (response): Four bits are allocated to each node address to provide information on the status of the data links, as shown below. The function of each of the 4 bits is shown in the diagram following the table.

Byte	Bits 4 to 7	Bits 0 to 3
Byte 1	Node address 2	Node address 1
Byte 2	Node address 4	Node address 3
Byte 3	Node address 6	Node address 5
⋮	⋮	⋮
Byte 31	Node address 62	Node address 61

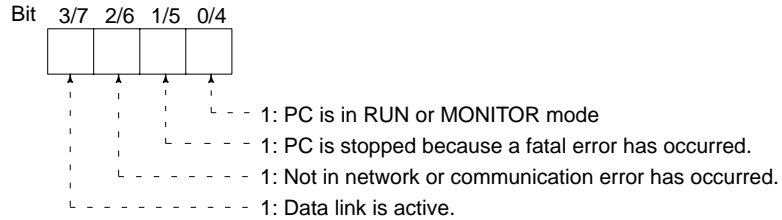

7-9-8 INTERNODE ECHO TEST

Performs an internode echo test with the indicated node.

Command Block

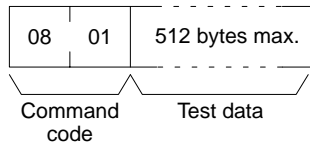

Response Block

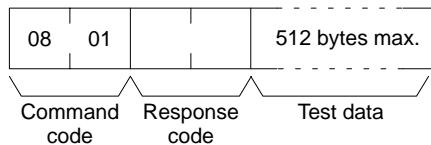

Parameters

Test data (command and response): Up to 512 byte of test data can be included in the command. This data is transmitted to the indicated node and returned unchanged if communications are normal. If the data returned in the response differs from that transmitted in the command, an error occurred in the internode echo test.

7-9-9 BROADCAST TEST RESULTS READ

Reads the results (number of receptions for each node) of the broadcast tests carried out using the BROADCAST TEST DATA SEND command. Refer to 7-9-10 BROADCAST TEST DATA SEND for details on that command.

Command Block

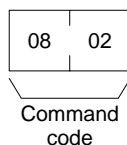

Response Block

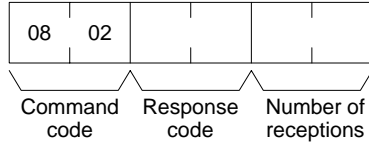

Parameters

Number of receptions (response): The number of times that the BROADCAST TEST DATA SEND command has been executed since the last BROADCAST TEST RESULTS READ command was executed.

When this command is executed, the number of receptions data stored in the destination nodes is cleared. If the number of receptions does not equal the number of times that the BROADCAST TEST DATA SEND command has been executed since the last BROADCAST TEST RESULTS READ command was executed, an error has occurred.

7-9-10 BROADCAST TEST DATA SEND

Sends the test data in the command to all nodes in the specified network. No response will be returned when this command is executed, but reception of the test data can be verified by executing the BROADCAST TEST RESULTS READ command. Refer to 7-9-9 BROADCAST TEST RESULTS READ for details.

Command Block

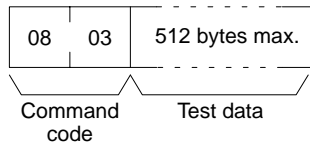

Note Make the following control data settings when executing this command:

- a) Destination node address: FF (broadcast transmission)
- b) Destination node unit number: FE (to SYSMAC LINK Units)
- c) Response Flag (bit 13 of C+1): ON (response not returned)

7-9-11 ERROR LOG READ

Reads the PC's error log.

- Note**
1. When the PC does not have the specified number of records, all the records that have been stored in the PC will be read and an address range overflow error will result.
 2. If the data is too large and exceeds the permissible length of the response block, the part in excess will not be read and a response length overflow error will result.

Command Block

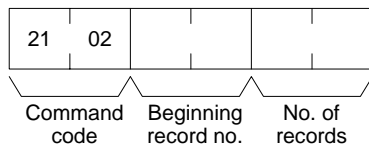

Response Block

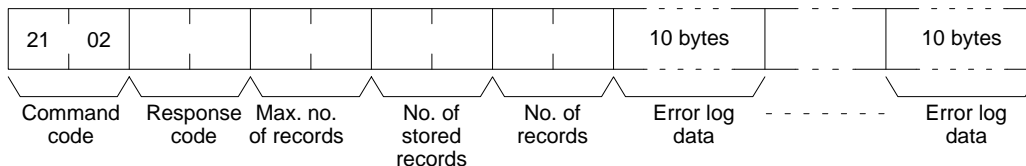

Parameters

Beginning record no. (command): The first record to be read (the first record number is 0000).

Max. no. of records (response): The maximum number of records that can be recorded.

No. of stored records (response): The number of records that have been recorded.

No. of records (command and response): The number of records read. Specify between 0000 and 0035 (0 and 53 records). If the number of records is not specified, all records to present will be read and a normal response code will be returned. If the number of records causes the response to exceed 540 bytes, records through 540 bytes will be returned and an error response will be returned saying that the response was too long.

Error log data (response): The specified error log records will be returned in sequence starting from the beginning record number. The total number of bytes required is calculated as follows:

$$\text{Number of records} \times 10 \text{ bytes}$$

The configuration of each error record is as follows:

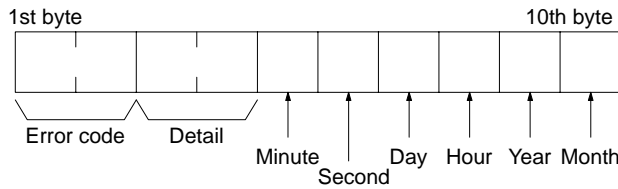

Each data includes the second, minute, hour (0 to 23), date, month, and year (the rightmost two digits) in BCD specifying the time that the error occurred.

7-9-12 ERROR LOG CLEAR

Clears all error log records.

Note This command cannot be executed if any other device has the access right.

Command Block

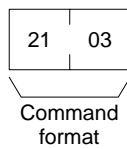

Response Block

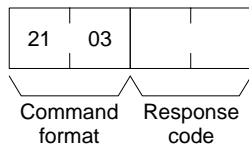

SECTION 8

Special Services

Information on remote programming and monitoring and RAS (Reliability, Assurance, and Safety) functions is provided in this section.

8-1	Remote Programming and Monitoring	132
8-2	Internode Echo Test	132
8-2-1	Test Parameters	132
8-2-2	Test Execution	133
8-2-3	Indicators and Flags	133
8-2-4	Results	134
8-3	Broadcast Test	136
8-4	Error Log	137
8-4-1	Features	137
8-4-2	Error Codes	137
8-4-3	Time Data	139
8-5	Polling Unit Backup	139
8-6	Node Bypasses	140

8-1 Remote Programming and Monitoring

Network PCs can be remotely programmed and monitored using the CVSS running on a IBM AT PC or compatible connected to any other PC on the network. Remote programming and monitoring is also possible for remote networks as long as the remote network is not separated from the CVSS network by more than one other network. More limited programming and monitoring is also possible with the CV-series GPC (Graphics Programming Console) under the same conditions.

Remote Communications Limits

The CVSS or GPC can provide remote programming and monitoring capability for all PCs in the local network, in any network directly connected to the local network, or in any network separated from the local network by no more than one other network. This range is the same as applies for data transfers and commands.

8-2 Internode Echo Test

The internode echo test involves transmitting data to a specific node and requesting the node to send back the data that was sent. The results of the test are stored in memory. Refer to 7-9-8 *INTERNODE ECHO TEST* for details.

Tests between nodes can also be executed using CVSS or network computers. Refer to CVSS or NSB operation manuals for details.

Internode Test Execution

The test is initiated by moving the required data to specified words in the DM area. There are separate words for each unit number.

The overall procedure for the test is as follows:

- 1, 2, 3...
 1. Place the require data in the specified words in the DM area.
 2. Turn ON the software switch in the memory of the PC to start the test.
 - a) Test data is transmitted to the specified node.
 - b) The specified node returns the test data unaltered.
 - c) The original test data is compared to the data which was echoed back. If there is any discrepancy, an error code is generated.
 3. Turn OFF the software switch in the memory of the PC to stop the test.
 4. Check the test results to see if an error has occurred.

8-2-1 Test Parameters

The following parameters must be stored in PC memory before executing a test. The memory area for the test will be in the DM area, with the specific words determined by the unit number as follows:

$D02000 + (100 \times \text{unit number})$.

Unit no.	Words	Unit no.	Words
0	D02000 to D02002	8	D02800 to D02802
1	D02100 to D02102	9	D02900 to D02902
2	D02200 to D02202	10	D03000 to D03002
3	D02300 to D02302	11	D03100 to D03102
4	D02400 to D02402	12	D03200 to D03202
5	D02500 to D02502	13	D03300 to D03302
6	D02600 to D02602	14	D03400 to D03402
7	D02700 to D02702	15	D03500 to D03502

Word	Bit	Item	Value
+0	0 to 15	Kind of test	Always 0000
+1	0 to 7	Destination node address	01 to 3E (hexadecimal)
	8 to 15	Destination network address	00 to 7F (hexadecimal)
+2	0 to 7	No. of transmission bytes	00 to FF (hexadecimal) 00: 512 bytes
	8 to 15	Response monitor time	00 to FF (hexadecimal) with 100-ms increments 00: Default value (2 s) FF: No response monitor

8-2-2 Test Execution

Start Tests between two nodes will start and continue when bit 01 on the first word of the first word allocated to the SYSMAC LINK Unit in the CPU Bus Unit Area is turned ON (refer to 4-6 Memory Areas). The first word is 1500 + (25 x unit no.).

Stop To stop the test, turn OFF the bit (set to 0) that has been turned ON.

Unit no.	Test Control Bit	Unit no.	Test Control Bit
0	150001	8	170001
1	152501	9	172501
2	155001	10	175001
3	157501	11	177501
4	160001	12	180001
5	162501	13	182501
6	165001	14	185001
7	167501	15	187501

8-2-3 Indicators and Flags

Indicators The status of the test is shown by the TS indicator.

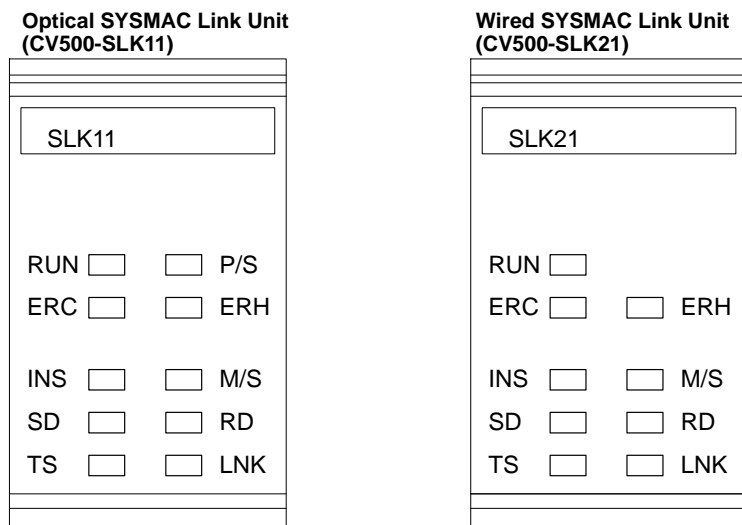

Indicator			Meaning
Name	Color	Condition	
TS (test)	Orange	Lit	Test is being executed.
		Flashing	Test setting error has occurred.
		Not lit	Test is not being executed.

Test Execution Flag

Whether or not the test is or is not currently being executed is shown in bit 00 of the 24th word allocated to the SYSMAC LINK Unit in the CPU Bus Unit Area, i.e., bit 00 of word $1500 + (25 \times \text{unit number}) + 24$. If this bit is ON, the test is currently being executed. If it is OFF, the test is not currently being executed.

Unit no.	Test Control Bit	Unit no.	Test Control Bit
0	152400	8	172400
1	154900	9	174900
2	157400	10	177400
3	159900	11	179900
4	162400	12	182400
5	164900	13	184900
6	167400	14	187400
7	169900	15	189900

8-2-4 Results

The results of a test between nodes are stored in the DM Area (CPU bus unit area) of the PC.

Storage Position of Results

The following tables show where and how test results are stored. The relative position of the words are according to the first word allocated to each SYSMAC LINK Unit in the DM Area. The words allocated in the DM Area can be calculated from the unit number: $D02000 + (100 \times \text{unit no.}) + 10$ to 22.

Unit no.	First word	Data storage word	Unit no.	First word	Data storage word
0	D02000	D02010 to D02022	8	D02800	D02810 to D02822
1	D02100	D02110 to D02122	9	D02900	D02910 to D02922
2	D02200	D02210 to D02222	10	D03000	D03010 to D03022
3	D02300	D02310 to D02322	11	D03100	D03110 to D03122
4	D02400	D02410 to D02422	12	D03200	D03210 to D03222
5	D02500	D02510 to D02522	13	D03300	D03310 to D03322
6	D02600	D02610 to D02622	14	D03400	D03410 to D03422
7	D02700	D02710 to D02722	15	D03500	D03510 to D03522

Word	Bit	Item
+10	0 to 15	Kind of test (fixed to 0000)
+11	0 to 7	Destination node address
	8 to 15	Destination network address
+12	0 to 7	No. of transmission bytes
	8 to 15	Response monitor time
+13	0 to 15	No. of tests
+14	0 to 15	No. of errors
+15	0 to 15	Test status
+16	0 to 7	No. of times of token timed out
	8 to 15	No. of times that destination node did not participate in network
+17	0 to 7	No. of times that local node did not participate in network
	8 to 15	No. of times of data disagreement
+18	0 to 7	No. of times that destination node was busy
	8 to 15	No. of retry errors

Word	Bit	Item
+19	0 to 7	No. of times that no response was returned
	8 to 15	No. of times of maximum number of frames was exceeded
+20	0 to 7	No. of times that relay node routing failed
	8 to 15	No. of times that local node routing failed
+21	0 to 7	Main response code (MRES) when routing failed
	8 to 15	Sub-response code (SRES) when routing failed
+22	0 to 7	Network address where routing failed
	8 to 15	Node address where routing failed
+23 to 99	0 to 15	Not used

Meanings of Test Items

The meanings of test items are briefly explained as follows:

No. of tests

Means how many times the test was repeated.

No. of errors

Means the total of all errors.

Test status

Bits 00 to 10 will show the following.

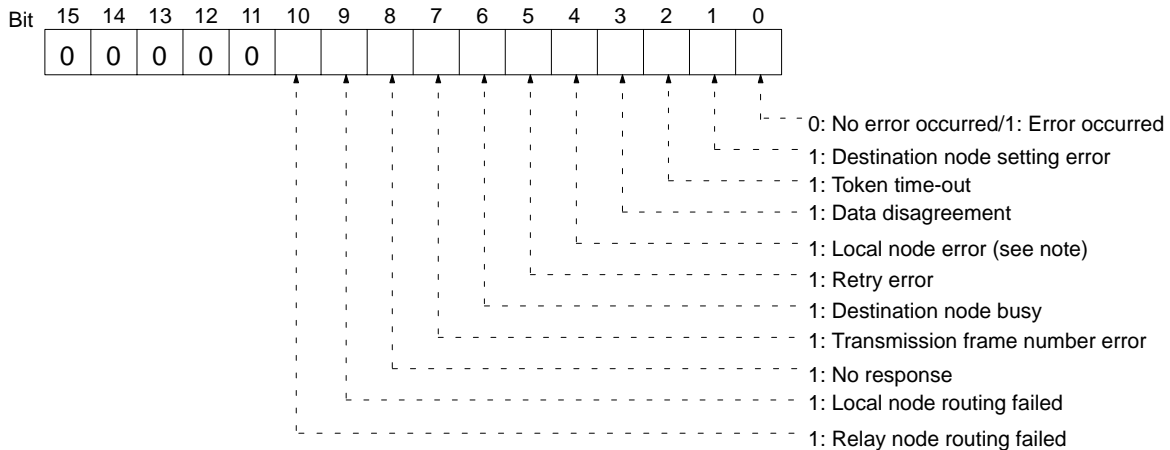

Note: This bit is also ON in the case of communications chip errors, node address setting errors, or node address duplication errors.

No. of times of token timed out

The number of times that the transmission node could not send the data because no token was received.

No. of times that destination node did not participate in network

The number of times that the destination node did not participate in the network.

No. of times that local node did not participate in network

The number of times that the local node did not participate in the network and transmission failed (including communications chip errors, node address setting errors, and node address duplication errors).

No. of times of data disagreement

The number of times that the transmission data and reception data did not match.

No. of times that destination node was busy

The number of times that the destination node was busy and no transmission to the destination node was possible.

No. of retry errors

The number of times that the destination node did not receive the re-transmitted data.

No. of times that no response was returned

The number of times that the destination node did not respond.

No. of times the maximum number of frames was exceeded

The number of times that the maximum number of frames per communications cycle was exceeded and the transmission failed.

No. of times that relay node routing failed

The number of times that the relay node routing failed (this may have happened because there was no routing table or designated network address or there was a routing table error).

No. of times that local node routing failed

The number of times that the local node was not routed to another network (this may have happened because there was a routing table error or there was no routing table or designated network address).

Main response code (MRES) at the time routing failed

A main response code will be provided when routing by the relay node failed.

Sub-response code (SRES) at the time routing failed

Returns with a main response code.

Network address where routing failed

The network incorporating the relay node that could not route to another network.

Node address where routing failed

The relay node address that could not route to another network.

- Note**
1. If the destination node is changed during a series of tests, all records will be reset.
 2. To carry out tests with remote networks, refer to *Section 6 Network Data Exchange*.
 3. Tests between nodes can be also executed using the echo-back test command.

8-3 Broadcast Test

The broadcast test transmits data to all nodes in the network simultaneously and then reads the results (number of receptions for each node) of the test. The broadcast test can also be executed with CV-mode commands. Refer to 7-9-10 *BROADCAST TEST DATA SEND* for details.

Broadcast Test Execution

The test can be executed with the CVSS or a computer. Refer to the CVSS or NSB manuals for details.

The test proceeds as follows:

- 1, 2, 3... 1. The test data is transmitted to all nodes the specified number of times.
2. The number of responses from each node is read.
3. The test results (the number of transmissions and successful receptions) are recorded.

8-4 Error Log

Errors which occur in data link operation or communications test are recorded in an error log in the SYSMAC LINK Unit. Error logs can be read or cleared from Peripheral Devices or other nodes.

8-4-1 Features

Items Recorded

Errors are recorded in the error log only during the normal operation of the SYSMAC LINK Unit. Any error occurring when turning the power on or when Unit operation is started will not be recorded because such errors should be discovered by the user immediately. The following errors are recorded:

- Errors in network communications
- Data exchange errors
- PC errors

Error Log Table

Error are recorded as individual records. The specifications of the error log record are as follows (2 bytes equals 1 word):

Item	Specification
Length of record	10 bytes
No. of records	64 max.
Data code	Binary
Configuration of record	Error code: 2 bytes Detail code: 2 bytes Time: 6 bytes

Error Log Overflows

When a new record is added to the error log that already has 64 records, the oldest record will be lost and the second oldest record will be regarded as the 1st (oldest) record. Consequently the new record will be the 25th record.

Note When you reset the SYSMAC LINK Unit, all records will be cleared.

8-4-2 Error Codes

The following table lists the error codes and the contents of the errors.

Error code	Contents	Detail code		Correction
		1st byte	2nd byte	
0001	PC watchdog timer error	00	00	Replace PC's CPU.
0002	PC service monitor error	Monitor time (unit: ms)		Check operating environment.
0003	PC common RAM error	01: Cyclic 02: Event 04: CPU bus link	00	Check operating environment.
0004	CPU Bus Unit ID number error	00	00	Check I/O Connecting Cables.

Error code	Contents	Detail code		Correction
		1st byte	2nd byte	
0101	Transmission failed; local node not in network	Command block Bits 0 to 7: Source node address Bits 8 to 14: Source network address Bit 15: 0 Response block Bits 0 to 7: Destination node address Bits 8 to 14: Destination network address Bit 15: 0 (1st byte: bits 0 to 7; 2nd byte, bits 8 to 15)		Place node into network.
0102	Transmission failed; token timed out			Set local node to node address lower than maximum node address.
0103	Transmission failed; retry count exceeded			Run internode test and check operating environment if errors occur.
0104	Transmission failed; maximum number of frames exceeded.			Reduce number of events per communications cycle or increase maximum number of frames.
0105	Transmission failed; node address incorrect			Check node address settings to be sure they are within range and unique.
0106	Transmission failed; redundant node address			Correct node addresses so that they are unique.
0107	Transmission failed; destination node not in network			Place destination node into network.
0108	Transmission failed; specified Unit does not exist			Check unit address of destination.
0109	Transmission failed; destination busy			Increase number of retries or reconfigure system to distribute load.
010A	Transmission failed; communications controller error			Refer to <i>Section 9 Error Processing</i> .
010B	Transmission failed; PC error			Refer to PC operating manuals.
010C	Transmission failed; unit number incorrect			Check unit number settings to be sure they are within range and unique.
010D	Transmission failed; destination address incorrect			Check routing tables.
010E	Transmission failed; routing tables not registered			Check routing tables
010F	Transmission failed; routing table error			Check routing tables.
0110	Transmission failed; too many relay points			Check routing tables and system configuration. Do not try to access networks separated by more than one other network.
0111	Transmission failed; command packet too long			Correct command format.
0113	Transmission failed; I/O setting error			Check I/O table accuracy.
0114	Transmission failed; CPU bus error	Check Unit and cable connections and clear error (21 01).		
0115	Transmission failed; redundant I/O allocations	Check unit numbers for redundancy.		
0116	Transmission failed; CPU Bus Unit error	Check Unit and cable connections and clear error (21 01).		
0117	Internal buffer full	Increase number of retries or reconfigure system to distribute load.		
0118	Illegal packet discarded	Check for nodes sending illegal packets.		

Error code	Contents	Detail code		Correction
		1st byte	2nd byte	
0206	Number of participating nodes decreased (local node still participating)	Maximum node address	Number of non-participating nodes	Check network parameters, node participation, cables, and Terminator.
0207	Number of participating nodes decreased (local node not participating)			
0208	Polling unit changed	Address of previous polling unit	Address of new polling unit	Check previous polling unit.
0209	Network parameter disagreement	00	Address of polling unit	Check network parameters.
0212	Communications controller unable to send/receive	00	---	Check cables, connectors, and Terminator.
0216	Power supply error	00	01: OFF to ON 02: ON to OFF	Check Power Supply Units.

8-4-3 Time Data

Time data is recorded in numerical order according to the word address as follows:

Word	Bit	Data	Setting range
+0	0 to 7	Seconds	BCD: 00 to 59
	8 to 15	Minutes	BCD: 00 to 59
+1	0 to 7	Hour	BCD: 00 to 23 (24-hour system)
	8 to 15	Day	BCD: 01 to 31
+2	0 to 7	Month	BCD: 01 to 12
	8 to 15	Year	BCD: 00 to 99 (rightmost two digits of the year)

Note All time data is in binary coded decimal, i.e., each digit must be between 0 and 9.

8-5 Polling Unit Backup

If the polling unit on the SYSMAC LINK Network has an error, the polling unit backup function of the SYSMAC LINK Unit will reconstruct the network so that another Unit takes its place as the polling unit. Refer to the following diagram. The initial polling unit is the Unit assigned node address 1. If the Unit with node address 1 has an error, the node that has the next smallest node address will automatically become the new Polling Unit.

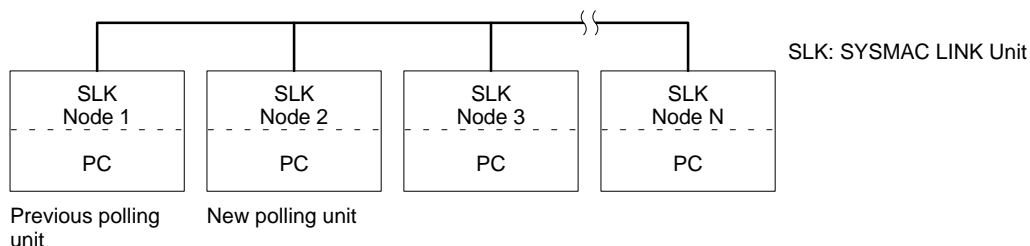

Note While the network is being reconstructed, no communications are possible. If the data link function was active, all data will remain at it's present values. When the network has been reconstructed, the data links will be reactivated. The approximate time required for the reconstruction of the network can be computed as follows:

$$(\text{Address of new polling unit} + 1) \times 20 \text{ ms} + \text{maximum node address} \times 1 \text{ ms}$$

8-6 Node Bypasses

Optical SYSMAC LINK networks can include a backup power supply connected to C1000H-APS01 Auxiliary Power Supply Units. If a backup power supply is provided, the node bypass function of the SYSMAC LINK Units will operate whenever a node or node power supply fails. The failing node will be bypassed in the network, the overall network will continue operating, preventing total network shutdown.

In this example if the Unit assigned node address 3 has an error, the node bypass function will eliminate this node from the network and the remainder of the network will continue functioning.

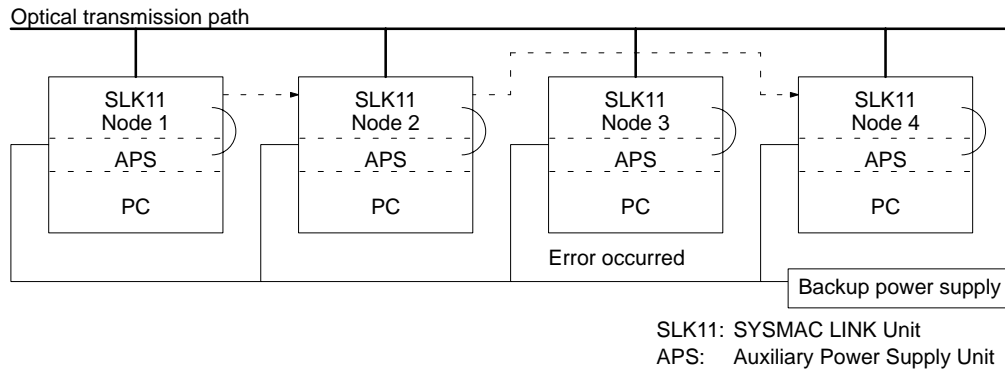

SECTION 9

Error Processing

Information to help identify and correct errors that might occur is provided in this section.

9-1	Troubleshooting	142
9-2	Network Troubleshooting	149

9-1 Troubleshooting

Error Indications

The table below lists error conditions, their probable cause, and possible remedies.

Error indicator	Probable cause	Remedy
RUN indicator not lit	SYSMAC LINK Unit faulty	Replace Unit.
	PC not connected to power supply	Connect to power supply (check connectors).
	PC's power supply voltage too low	Adjust voltage to within recommended range.
	SYSMAC LINK Unit mounting screws are loose.	Tighten screws.
	SYSMAC LINK Unit mounted in wrong slot.	Move Unit to correct slot.
ERC indicator lit	PC faulty.	Replace PC.
	Communications controller faulty	Replace Unit.
ERH indicator lit	Error in setting node address	Reset node address and restart the Unit.
	Unit mounted to faulty PC.	Replace PC.
	Unit mounted to incompatible PC.	Replace PC.
	PC's EEPROM error	Check routing tables, network parameters, and data link tables or replace the PC's CPU.
	Unit number is redundant or out of range.	Correct unit number and restart Unit.
	I/O table incorrect.	Regenerate the I/O table.
INS indicator not lit	Watchdog timer error in PC.	Replace PC.
	Terminator connection faulty	Connect Terminator correctly.
	Cable connection faulty	Connect cables correctly
	Local node's node address greater than the maximum node address set in the polling unit's network parameters	Increase the maximum node address or decrease the local node address
LNK indicator flashing	Data link table error on local node	Re-create data link table
	Error when reading EEPROM	Re-create data link table or replace PC
	Data link table of currently operating node and data link table of the local node don't match	Stop data link and modify the data link table of either the currently operating node or the local node so they match.
	Local node has no data link table	Create a data link table.

 **Caution** Node addresses cannot be modified with the power on. To change node addresses, first turn off the power, then change the settings, making sure not to duplicate any node addresses.

CV-mode Command Errors The table below lists response codes (main and sub-codes) returned after execution of the CV-mode commands, the probable cause of errors, and recommended remedies.

The 6th, 7th, and 15th bits of the response codes have specific functions. The 6th bit will be ON when a non-fatal error has occurred in the PC at the destination; the 7th bit will be ON when a fatal error has occurred in the PC at the destination; and the 15th bit will be ON when a network relay error has occurred (see information after following table).

Upon receipt of some commands, the destination node will issue a request to another node; the other node is referred to as the third node.

Main code	Sub-code	Probable cause	Remedy
00: Normal completion	00	---	---
	01	Service was interrupted	Check the contents of the destination transmission area of third node.
01: Local node error	01	Local node not part of Network	Add to Network.
	02	Token time-out, node address too high	Set the local node's node address below the maximum node address
	03	Number of transmit retries exceeded	Check communications with internode echo test. If the test fails, check network.
	04	Maximum number of frames exceeded	Either check the execution of events in the network and reduce the number of events occurring in one cycle, or increase the maximum number of frames.
	05	Node address setting error (range)	Make sure the node address is within specified range and that there are no duplicate node addresses.
	06	Node address duplication error	Make sure that there are no duplicate node addresses.
02: Destination node error	01	Destination node not part of Network	Add to Network.
	02	No node with the specified node address	Check the destination node's node address.
	03	Third node not part of Network	Check the third node's node address.
	04	Busy error, destination node busy	Increase the number of transmit retry attempts or re-evaluate the system so that the destination node is not so busy receiving data.
		Response time-out, message packet was corrupted by noise	Increase the number of transmit retry attempts. Perform an internode echo test to check noise level.
	Response time-out, response watchdog timer interval too short	Increase the value for the response watchdog timer interval.	
03: Communications controller error	01	Error occurred in the communications controller, ERC indicator is lit	Take corrective action, referring to communications controller errors and remedies table at end of this section
	02	CPU error occurred in the PC at the destination node	Clear the error in the CPU (refer to the PC's operation manuals)
	04	Node address setting error	Make sure the node address is within specified range and that there are no duplicate node addresses.
04: Not executable	01	An undefined command has been used.	Check the command code.
	02	Cannot process command because the specified unit model or version is wrong.	Check the unit model and version.

Main code	Sub-code	Probable cause	Remedy
05: Routing error	01	Destination node address is not set in the routing table.	Set the destination node address in the routing table.
	02	Routing table isn't registered.	Set the source nodes, destination nodes, and relay nodes in the routing table.
	03	Routing table error	Set the routing table correctly.
	04	The maximum number of relay nodes (2) was exceeded in the command.	Redesign the network or reconsider the routing table to reduce the number of relay nodes in the command.
10: Command format error	01	The command is longer than the max. permissible length.	Check the command format of the command and set it correctly.
	02	The command is shorter than min. permissible length.	Check the command format of the command and set it correctly.
	03	The designated number of data items differs from the actual number.	Check the number of items and the data, and make sure that they agree.
	04	An incorrect command format has been used.	Check the command format of the command and set it correctly.
	05	An incorrect header has been used. (The local node's relay table or relay node's local network table is wrong.)	Set the routing table correctly.
11: Parameter error	01	A correct memory area code has not been used or Expansion Data Memory is not available.	Check the command's memory area code and set the appropriate code.
	02	The access size specified in the command is wrong, or the first address is an odd number.	Set the correct access size for the command.
	03	The first address is in an inaccessible area.	Set a first address that is in an accessible area.
	04	The end of specified word range exceeds the acceptable range.	Check the acceptable limits of the data area and set the word range within the limits.
	06	A non-existent program no. has been specified.	Check the program number and be sure that it is set correctly.
	09	The sizes of data items in the command block are wrong.	Check the command data and be sure that the sizes of the data items are correct.
	0A	The IOM break function cannot be executed because it is already being executed.	Either abort the current IOM break function processing, or wait until it is completed and execute the command.
	0B	The response block is longer than the max. permissible length.	Check the command format and set the number of items correctly.
	0C	An incorrect parameter code has been specified.	Check the command data and reenter it correctly.
	20: Read not possible	02	The program area is protected.
03		The registered table does not exist or is incorrect.	Set or reset the registered table.
04		The corresponding data does not exist.	---
05		A non-existing program no. has been specified.	Check the program number and be sure that it is set correctly.
06		A non-existing file has been specified.	Check whether the correct file name was used.
07		A verification error has occurred.	Check whether the memory contents are correct and replace if incorrect.

Main code	Sub-code	Probable cause	Remedy
21: Write not possible	01	The specified area is read-only or is write-protected.	If the specified area is read-only, the write cannot be performed. If it is write-protected, turn off the write-protect switch and execute the instruction again.
	02	The program area is protected.	Execute the instruction again after issuing the PROGRAM AREA PROTECT CLEAR command.
	03	The number of files exceeds the maximum permissible.	Write the file(s) again after erasing unneeded files, or use different disk or Memory Card that has free space.
	05	A non-existing program no. has been specified.	Check the program number and be sure that it is set correctly.
	06	A non-existent file has been specified.	---
	07	The specified file already exists.	Change the name of the file and execute the instruction again.
22: Not executable in current mode	01	The mode is wrong (executing).	Check the operating mode.
	02	The mode is wrong (stopped).	Check the operating mode.
	03	The PC is in the PROGRAM mode.	Check the PC's mode.
	04	The PC is in the DEBUG mode.	Check the PC's mode.
	05	The PC is in the MONITOR mode.	Check the PC's mode.
	06	The PC is in the RUN mode.	Check the PC's mode.
	07	The specified node is not the control node.	Check which node is the control node.
	08	The mode is wrong and the step cannot be executed.	Check whether the step has active status or not.
23: No Unit	01	A file device does not exist where specified.	The Memory Card or disk is not installed.
	02	The specified memory does not exist.	Check the specifications of the installed file memory.
	03	No clock exists.	Check the model number.
24: Start/stop not possible	01	The data link table either hasn't been created or is incorrect.	Set the data link table correctly.

Main code	Sub-code	Probable cause	Remedy
25: Unit error	02	Parity/checksum error occurred because of incorrect data.	Transfer correct data into memory.
	03	I/O setting error (The registered I/O configuration differs from the actual.)	Either change the actual configuration to match the registered one, or generate the I/O table again.
	04	Too many I/O points	Redesign the system to remain within permissible limits.
	05	CPU bus error (An error occurred during data transfer between the CPU and a CPU Bus Unit.)	Check the unit and cable connections and issue the ERROR CLEAR command.
	06	I/O duplication error (A rack number, unit number, or I/O word allocation has been duplicated.)	Check the system's settings and eliminate any duplication.
	07	I/O bus error (An error occurred during data transfer between the CPU and an I/O Unit.)	Check the unit and cable connections and issue the ERROR CLEAR command.
	09	SYSMAC BUS/2 error (An error occurred during SYSMAC BUS/2 data transfer.)	Check the unit and cable connections and issue the ERROR CLEAR command.
	0A	Special I/O Unit error (An error occurred during CPU Bus Unit data transfer.)	Check the unit and cable connections and issue the ERROR CLEAR command.
	0D	Duplication in SYSMAC BUS word allocation.	Check and regenerate the I/O table.
	0F	A memory error has occurred in internal memory, in the Memory Card, or in Expansion DM during the error check.	<p>If the error occurred in internal memory or the EM Unit, correct the data in the command and execute it again.</p> <p>If the error occurred in a Memory Card or EM used for file memory, the file data has been corrupted. Execute the MEMORY CARD FORMAT command.</p> <p>If the above remedies do not eliminate the error, replace the faulty memory.</p>
10	Terminator not connected in SYSMAC BUS System.	Connect the terminator correctly.	

Main code	Sub-code	Probable cause	Remedy
26: Command error	01	The specified area is not protected. This response code will be returned if an attempt is made to clear protection on an area that is not protected.	The program area is not protected, so it isn't necessary to clear protection.
	02	An incorrect password has been specified.	Specify a password that is registered.
	04	The specified area is protected.	Execute the command again after the PROGRAM AREA PROTECT CLEAR command.
	05	The service is being executed.	Execute the command again after the service has been completed or aborted.
	06	The service is not being executed.	Execute the service if necessary.
	07	Service cannot be executed from local node because the local node is not part of the data link.	Execute the service from a node that is part of the data link.
	08	Service cannot be executed because necessary settings haven't been made.	Make the necessary settings.
	09	Service cannot be executed because necessary settings haven't been made in the command data.	Check the command format of and make the necessary settings.
	0A	The specified action or transition number has already been registered.	Execute the command again using an action or transition number that hasn't been registered.
	0B	Cannot clear error because the cause of the error still exists.	Eliminate the cause of the error and execute the ERROR CLEAR command.
30: Access right error	01	The access right is held by another device.	Execute the command again after the access right has been released. (The command can be executed after the ACCESS RIGHT FORCED ACQUIRE or ACCESS RIGHT RELEASE command is completed. Releasing the access right might affect processes in progress at the node that held the access right.)

Network Relay Errors

For network relay errors using SEND(192) or RECV(193), check the path of the command using the routing tables and the nature of the error using the response code to eliminate the cause of the error.

For network relay errors using CMND(194), the location of the relay error is recorded in the second and third words of the response, as shown below.

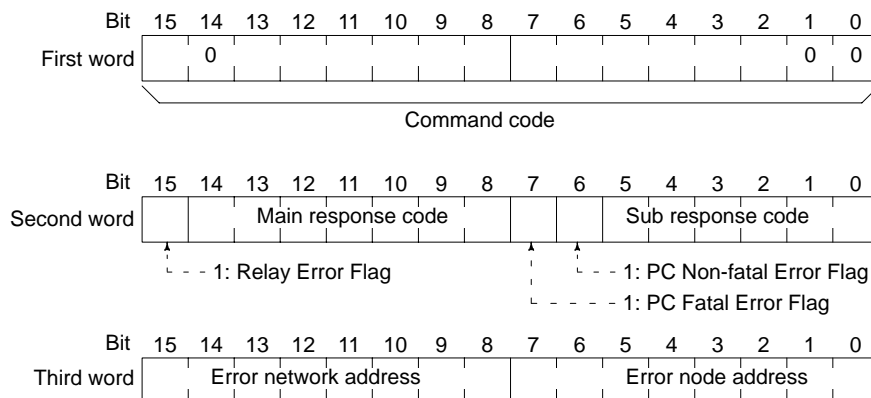

Data Link Status Errors

The following table lists data link status errors, their probable cause, and possible remedies. Check all nodes in question. The items in the *Data link status* column refer to the Data Link Status words allocated in the CPU Bus Link Area.

Data link status	Probable cause	Remedy
PC Error Flag ON	A fatal error has caused the CPU to halt (FALS instruction generated, etc.) CPU error	Clear the error in the CPU, referring to the Unit's Operating Manual and Installation Guide.
	Connected to an incompatible PC	Connect only to compatible PCs.
Communications Error Flag ON	Error resulting from noise	Run an internode echo test; if the results are not OK, re-check the operating environment.
	Unit in question is not part of the Network	Add the Unit to the Network.
	Communications cycle time too short	Increase communications cycle time.
Node not in data link	Node in question is not part of the data link	Add the node in question to the data link.

Other Errors

The table below lists other errors not covered above. Probable causes and remedies are also provided.

Error	Probable cause	Remedy	
Communications Controller error	Noise or environmental influences	Run an internode echo test; if an error occurs, recheck the operating environment.	
	Consider replacing communications-related hardware if one of the following errors occurs: · Communications Controller watchdog timer error · Communications Controller memory error · Communications Controller chip bad · Transmitter portion of Communications Controller bad · Local node internode echo test error	Reinitialize the SYSMAC LINK Unit. If the problem recurs, replace the Unit.	
Routing table error	EEPROM error	Routing table error	Remake the routing table.
	EEPROM is normal	Logic error	
Data link table error	EEPROM error	Data link table error	Remake the data link table.
	EEPROM is normal	Logic error	
Network parameter error	EEPROM error	Network parameter error	Reset the network parameter.
	EEPROM is normal	Logic error	
System setting switch error	EEPROM error	System setting switch error	Reset the data link table and network parameter.
	EEPROM is normal	Protection ON	Set the PC's protect switch to OFF.
Network Parameters disagree	Network parameters being used in the currently operating Network do not match the network parameters set in the Unit in question.	Use the FIT or host computer to check the network parameters and reset them if necessary.	

9-2 Network Troubleshooting

Use the headings in this section to troubleshoot problems that occur in the Network and find a list of the probable causes of the problem.

Unable to operate Network

Check indicators on the entire Network.

RUN indicator not lit

- Check whether power is being supplied to the PC at adequate voltage.
- Check whether mounting screws on Unit are tight.
- Check whether the Unit is mounted in a permissible slot on the Rack.
- Check whether the Unit operates normally when mounted on another PC.
- If none of the actions above solve the problem, replace suspect SYSMAC LINK Units.

INS indicator not lit

- Check whether local node address is greater than the maximum node address setting. If it is, lower local node address or increase maximum node address.
- Check whether the same node address has been assigned twice.
- In coaxial cable systems, check whether the Terminators are connected properly.
- Check whether all cables are connected properly.
- Check whether the cables transmit properly.
- Check to see if more than one node is set to be the polling unit.

Unable to add local node to Network

A local node cannot be added to the Network. (Check indicators on the node which cannot be added.)

RUN indicator not lit

- Check whether power is being supplied to the PC at adequate voltage.
- Check whether mounting screws on Unit are tight.
- Check whether the Unit is mounted in a permissible slot on the Rack.
- Check whether the Unit operates normally when mounted on another PC.
- If none of the actions above solve the problem, replace suspect SYSMAC LINK Units.

ERC indicator lit

- Check the PC's Communications Controller Error Flags. If ON, replace the SYSMAC LINK Unit.
- Check whether node address is within the range of 1 to 62. If not, reset to a unique node address from 1 to 62 (duplicate node addresses not permitted).
- Check for duplicate node addresses. Make sure each node address is assigned to only one unit.

ERH indicator lit

- Check whether the Unit is mounted to an incompatible model or version or PC. Replace PC if necessary.
- Check for CPU error in the PC. Switch power off and turn on again. If problem occurs again, replace PC.
- Check for EEPROM error.

INS indicator not lit

- Check whether local node address is greater than the maximum node address setting. If it is, lower local node address or increase maximum node address.

- Check whether the same node address has been assigned twice.
- In coaxial cable systems, check whether the Terminators are connected properly.
- Check whether all cables are connected properly.
- Check whether the cables transmit properly.

Data link cannot be started

Data link does not operate properly. Check indicators on the data link nodes.

LNK indicator is not lit and

RUN indicator not lit

- Check whether power is being supplied to the PC at adequate voltage.
- Check whether mounting screws on Unit are tight.
- Check whether the Unit is mounted in a permissible slot on the Rack.
- Check whether the Unit operates normally when mounted on another PC.
- If none of the actions above solve the problem, replace SYSMAC LINK Units.

ERC indicator lit

- Check the PC's Communications Controller Error Flags. If ON, replace the SYSMAC LINK Unit.
- Check whether node address is within the range of 1 to 62. If not, reset to a unique node address from 1 to 62 (duplicate node addresses not permitted).
- Check for duplicate node addresses. Make sure each node address is assigned to only one unit.

ERH indicator lit

- Check whether the Unit is mounted to an incompatible model or version or PC. Replace PC if necessary.
- Check for CPU error in the PC. Switch power off and turn on again. If problem occurs again, replace PC.
- Check for EEPROM error.

INS indicator not lit

- Check whether local node address is greater than the maximum node address setting. If it is, lower local node address or increase maximum node address.
- Check whether the same node address has been assigned twice.
- In coaxial cable systems, check whether the Terminators are connected properly.
- Check whether all cables are connected properly.
- Check whether the cables transmit properly.

LNK indicator flashing

- Check whether a data link table has been created. If not, generate one.
- Check whether an EEPROM error has occurred. If so, investigate EEPROM error causes and remedies as outlined on page 148.
- If a data link is already operating on the same Network, bring that data link to a halt, and start the data link that has the problem.
- If the LNK indicator flashing on other nodes, stop the data links in those nodes.

Data link cannot be stopped

Data link does not operate properly. Check indicator indicators on the data link nodes.

LNK indicator is not lit and

RUN indicator not lit

- Check whether power is being supplied to the PC at adequate voltage.

- Check whether mounting screws on Unit are tight.
- Check whether the Unit is mounted in a permissible slot on the Rack.
- Check whether the Unit operates normally when mounted on another PC.
- If none of the actions above solve the problem, replace suspect SYSMAC LINK Units.

ERC indicator lit

- Check the PC's Communications Controller Error Flags. If ON, replace the SYSMAC LINK Unit.
- Check whether node address is within the range of 1 to 62. If not, reset to a unique node address from 1 to 62 (duplicate node addresses not permitted).
- Check for duplicate node addresses. Make sure each node address is assigned to only one unit.

ERH indicator lit

- Check whether the Unit is mounted to an incompatible model or version or PC. Replace PC if necessary.
- Check for CPU error in the PC. Switch power off and turn on again. If problem occurs again, replace PC.
- Check for EEPROM error.

INS indicator not lit

- Check whether local node address is greater than the maximum node address setting. If it is, lower local node address or increase maximum node address.
- Check whether the same node address has been assigned twice.
- In coaxial cable systems, check whether the Terminators are connected properly.
- Check whether all cables are connected properly.
- Check whether the cables transmit properly.

Node cannot join data link

Node cannot be entered into the data link. Check indicators on the node which you want to add to data link.

LNK indicator is not lit and**RUN indicator not lit**

- Check whether power is being supplied to the PC at adequate voltage.
- Check whether mounting screws on Unit are tight.
- Check whether the Unit is mounted in a permissible slot on the Rack.
- Check whether the Unit operates normally when mounted on another PC.
- If none of the actions above solve the problem, replace suspect SYSMAC LINK Units.

ERC indicator lit

- Check the PC's Communications Controller Error Flags. If ON, replace the SYSMAC LINK Unit.
- Check whether node address is within the range of 1 to 62. If not, reset to a unique node address from 1 to 62 (duplicate node addresses not permitted).
- Check for duplicate node addresses. Make sure each node address is assigned to only one unit.

ERH indicator lit

- Check whether the Unit is mounted to an incompatible model or version or PC. Replace PC if necessary.
- Check for CPU error in the PC. Switch power off and turn on again. If problem occurs again, replace PC.

- Check for EEPROM error.

INS indicator not lit

- Check whether local node address is greater than the maximum node address setting. If it is, lower local node address or increase maximum node address.
- Check whether the same node address has been assigned twice.
- In coaxial cable systems, check whether the Terminators are connected properly.
- Check whether all cables are connected properly.
- Check whether the cables transmit properly.

LNK indicator flashing

- Confirm that a data link table has been created. If not, do so.
- Check whether the data link tables of nodes which are currently in the data link match that of the local node. If not, stop data link operations and modify the data link table either in the local node or the nodes which are currently linked.
- If the data link tables do match, check whether an EEPROM error has occurred. If so, investigate EEPROM error causes and remedies.

LNK indicator still not lit

- When the data link tables have been generated automatically, confirm that the node address of the local node is within the range of node addresses set automatically. If not, either lower the node address of the local node so that it is within the range, or change the automatic settings in AR 07 to include the local node.
- Check whether the node address of the local node is included in the common link parameters in the data link tables of those nodes currently in the data link. If not, stop data link operations and modify the data link tables of either the active nodes or of the local node.

SECTION 10

Inspection and Maintenance

This section contains information describing periodic maintenance required by the System and how to replace a SYSMAC LINK Unit.

10-1	Periodic Inspection	154
10-2	Replacing SYSMAC LINK Units	154

10-1 Periodic Inspection

SYSMAC LINK Units must be inspected on a regular basis to ensure correct operation. SYSMAC LINK Units are built primarily of solid-state components and contain almost no parts subject to wear. Nevertheless, the life span of some solid-state components can be shortened as a result of adverse environmental conditions.

We recommend that the following points be checked at least once every 6 to 12 months as part of a standard inspection program. Ambient conditions should be checked more frequently. If any of these items deviate from the prescribed standards, take appropriate action to correct the condition.

Item	Description
Ambient conditions	Temperature: 0° to 55°C Humidity: 35% to 85% (no condensation) Dust-free SYSMAC LINK Units securely attached?
Installation	Cable connectors tight? Screws tightened on terminal blocks for external wiring? Cabling used for external wiring intact (no breaks)?

We recommend that users have backup Units available to make repairs and minimize down-time if a problem occurs in a SYSMAC LINK Unit.

Handling Precautions

Please observe the following precautions in the event of a problem:

- Always turn the power off when replacing a SYSMAC LINK Unit.
- If a SYSMAC LINK Unit fails, replace it with a new one and immediately verify that the new Unit is working properly.
- When returning a malfunctioning SYSMAC LINK Unit for repair, please attach a detailed description of the problem to the Unit and return it to the sales office nearest you (see listing at the end of this manual).
- If you suspect that a poor connection is the cause of a malfunction, clean the connectors using a clean, soft cloth and industrial-grade alcohol. Remove any lint or threads left from the cloth, and re-mount the SYSMAC LINK Unit.

Tools and Equipment Needed for Inspection

The following tools and equipment will be needed to perform inspection and adjustments.

- Assorted flat-blade and Phillips screwdrivers
- Circuit tester or digital VOM
- Industrial-grade alcohol and clean cotton cloth
- Synchroscope
- Pen-chart recording oscilloscope
- Thermometer, hygrometer

10-2 Replacing SYSMAC LINK Units



Caution

Data link tables and network parameters are stored in the EEPROM in the SYSMAC LINK Unit. Be extremely careful when removing this component from the old SYSMAC LINK Unit and inserting it in the new Unit.

Manually Set Data Link

If data links have been established manually, the data link table must be re-set after mounting the new Unit and before activating data links. If data link areas are set automatically, this re-set operation is unnecessary as long as SW1 and SW2 are set correctly.

Network Parameters

To use network parameters other than default values, use the following procedure after mounting the new Unit.

- 1, 2, 3...**
1. Set SW1 pin 8 to ON (polling unit setting*).
 2. After initializing the SYSMAC LINK Unit, confirm that it has correctly joined the Network by checking the indicators (INS indicator lit, and ERC and ERH indicators not lit indicate normal operation).
 3. Set SW1 pin 8 to OFF (polled unit setting*).
 4. After initializing the SYSMAC LINK Unit, confirm that it has correctly joined the Network by checking the indicators (INS indicator lit, and ERC and ERH indicators not lit indicate normal operation).

Appendix A Standard Models

SYSMAC LINK Units

Name	Specification	Model	Applicable PCs
SYSMAC LINK Unit	Optical fiber cable	CV500-SLK11	CV500-CPU01-E CV1000-CPU01-E CV2000-CPU01-E
	Coaxial cable	CV500-SLK21	CVM1-CPU01-E CVM1-CPU11-E

Auxiliary Power Supply Units

Name	Model	Applicable SYSMAC LINK Unit
Auxiliary Power Supply Unit	C1000H-APS01	CV500-SLK11

Cables

Optical Fiber Cable (for CV500-SLK11)

Use the following H-PCF cables:

Name	Specification	Model	
H-PCF Cable (2-core optical fiber cable)	Black	10 m	S3200-HCCB101
		50 m	S3200-HCCB501
		100 m	S3200-HCCB102
		500 m	S3200-HCCB502
		1,000 m	S3200-HCCB103
	Orange	10 m	S3200-HCCO101
		50 m	S3200-HCCO501
		100 m	S3200-HCCO102
		500 m	S3200-HCCO502
		1,000 m	S3200-HCCO503

When ordering, specify the optical fiber cable type by adding codes to the model number as shown below.

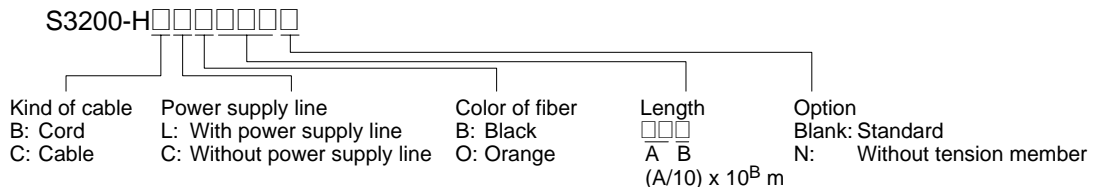

Coaxial Cable (for CV500-SLK21)

The following coaxial cables are recommended:

Name	Model	Maker
Coaxial cable	5C-2V	Fujikura Densen
	ECXF5C-2V	Hitachi Densen

Appendix B Specifications

Communications Specifications

Item	Specification	
	CV500-SLK21 (coaxial)	CV500-SLK11 (optical)
Communications method	Token ring (N:N)	
Transmission method	Manchester encoding, baseband	
Data transmission rate	2 Mbps	
Media	Coaxial cable (5C-2V)	2-carrier hard-plastic-clad quartz optical fiber cable
Transmission path	Bus	Daisy chain
No. of nodes	62 max.	
Distance between nodes	Total: 1 km	Total: 10 km (800 m max. between nodes)
Message length	542 bytes max. (not including header)	
Connectors	BNC (F Adaptor)	Full, half-lock press-in connector
Link functions	Data link, data read/write service	
Data link words	2,966 words max. in Link and DM Areas combined	
Send buffer capacity	1 message	
Receive buffer capacity	2 messages	
RAS functions	Automatic polling unit backup, self-diagnostics (internode echo tests), failed node bypass (optical systems only), watchdog timer, error (CRC-CCITT) detection = $X^{16} + X^{12} + X^5 + 1$, error log	

Appendix C

Internal Configuration

The diagrams below show the configuration of the internal components of SYSMAC LINK Units.

Optical Units (CV500-SLK11)

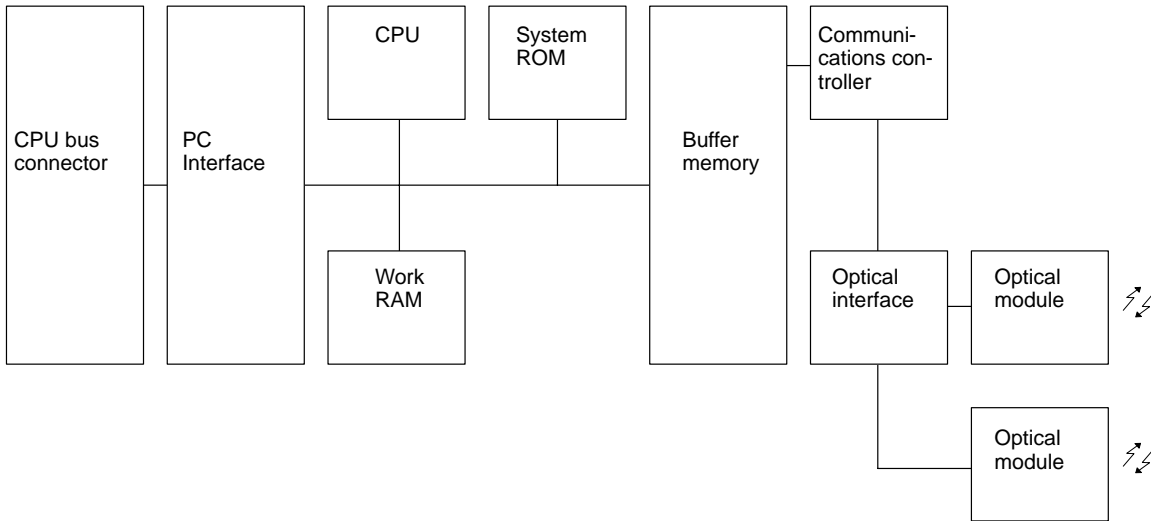

Note Network parameters and data link tables are backed up in EEPROM.

Coaxial-cable Units (CV500-SLK21)

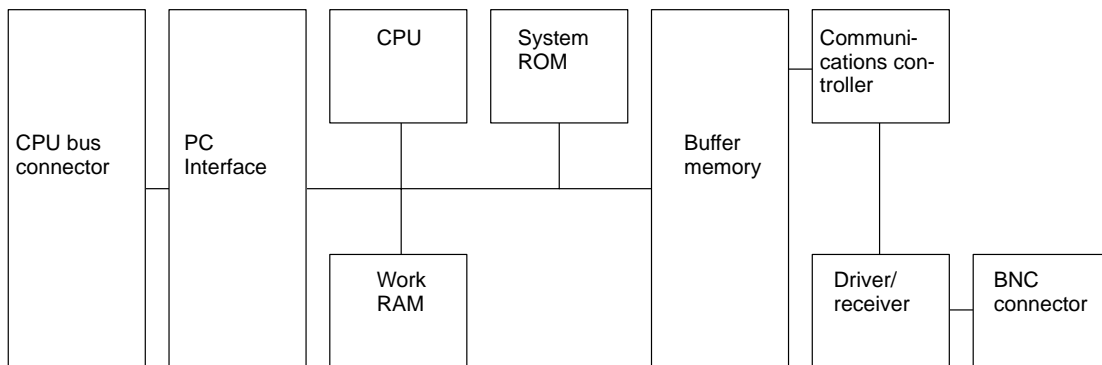

Note Network parameters and data link tables are backed up in EEPROM.

Appendix D

PC Data Area Information

Auxiliary Area

The information available in the Auxiliary Area of the PC for use with CPU Bus Units (SYSMAC LINK Units) is outlined in the following table and explained in more detail after it.

Word(s)	Bit(s)	Function
A001	00 to 15	CPU Bus Unit Restart Bits
A015	00 to 15	CPU Bus Service Disable Bits
A302	00 to 15	CPU Bus Unit Initializing Flags
A401	12	CPU Bus Error Flag
A402	03	CPU Bus Unit Setting Error Flag
	07	CPU Bus Unit Error Flag
A405	00 to 15	CPU Bus Unit Error Unit Number
A410	00 to 15	CPU Bus Unit Duplicate Number
A422	00 to 15	CPU Bus Unit Error Unit Number
A427	00 to 15	CPU Bus Unit Setting Error Unit Number
A502	00 to 07	Port #0 to #7 Enabled Flags
	08 to 15	Port #0 to #7 Execute Error Flags
A503 to A510	00 to 15	Port #0 to #7 Completion Codes

CPU Bus Unit Restart Bits

Bits A00100 through A00115 can be turned ON to reset CPU Bus Units number #0 through #15, respectively. The Restart Bits are turned OFF automatically when restarting is completed.

Do not turn these bits ON and OFF in the program; manipulate them from the CVSS.

CPU Bus Service Disable Bits

Bits A01500 through A01515 can be turned ON to stop service to CPU Bus Units numbered #0 through #15, respectively. Turn the appropriate bit OFF again to resume service to the CPU Bus Unit.

CPU Bus Unit Initializing Flags

Bits A30200 through A30215 turn ON while the corresponding CPU Bus Units (Units #0 through #15, respectively) are initializing.

CPU Bus Error and Unit Flags

Bit A40112 is turned ON when an error occurs during the transmission of data between the CPU and CPU Bus Units, or a WDT (watchdog timer) error occurs in a CPU Bus Unit. The unit number of the CPU Bus Unit involved is contained in word A405.

Bits A40500 through A40515 correspond to CPU Bus Units #0 through #15, respectively. When a CPU Bus Error occurs, the bit corresponding to the unit number of the CPU Bus Unit involved is turned ON.

CPU Bus Unit Setting Error Flag and Unit Number

Bit A40203 is turned ON when the CPU Bus Units actually installed differ from the Units registered in the I/O table. The unit number of the CPU Bus Unit involved is written to word A427.

Bits A42700 through A42715 correspond to CPU Bus Units #0 through #15, respectively. When a error occurs, the bit corresponding to the unit number of the CPU Bus Unit involved is turned ON.

CPU Bus Unit Error Flag and Unit Numbers

Bit A40207 is turned ON when a parity error occurs during the transmission of data between the CPU and CPU Bus Units. The unit number of the CPU Bus Unit involved is written to word A422.

Bits A42200 through A42215 correspond to CPU Bus Units #0 through #15, respectively. When a CPU Bus Unit Error occurs, the bit corresponding to the unit number of the CPU Bus Unit involved is turned ON.

CPU Bus Unit Numbers

Bits A41000 through A41015 correspond to CPU Bus Units #0 through #15, respectively. When two CPU Bus Units have the same unit number, the bits corresponding to the unit numbers of the CPU Bus Units involved are turned ON.

Network Status Flags

Bits A50200 through A50207 are turned ON to indicate that ports #0 through #7, respectively, are enabled for the SEND(192), RECV(193), and CMND(194). Bits A50208 through A50215 are turned ON to indicate that an error has occurred in ports #0 through #7, respectively, during data communications using SEND(192), RECV(193), or CMND(194).

A503 through A510 contain the completion codes for ports #0 through #7, respectively, following data communications using SEND(192), RECV(193), or CMND(194).

CPU Bus Unit Area

The CPU Bus Unit Area of the SYSMAC LINK Unit is allocated in the PC's memory (bit area) according to the unit number as follows (25 words are allocated per Unit):

Unit no.	Words	Unit no.	Words
0	1500 to 1524	8	1700 to 1724
1	1525 to 1549	9	1725 to 1749
2	1550 to 1574	10	1750 to 1774
3	1575 to 1599	11	1775 to 1799
4	1600 to 1624	12	1800 to 1824
5	1625 to 1649	13	1825 to 1849
6	1650 to 1674	14	1850 to 1874
7	1675 to 1699	15	1875 to 1899

Configuration of CPU Bus Unit Area

The configuration of the CPU Bus Unit Area of the SYSMAC LINK Unit is as follows:

Word	
+0	Software switches (1 word)
+1	Error data (1 word)
+2	
to	Network status (6 words)
+7	
+8	
to	Data link status (16 words)
+23	
+24	Test and power supply status (1 word)

Software Switch

Word: 1500 + (25 x unit no.)

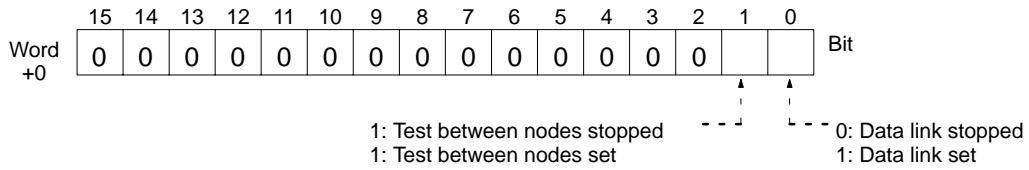

Error Data

Word: 1500 + (25 x unit no.) + 1

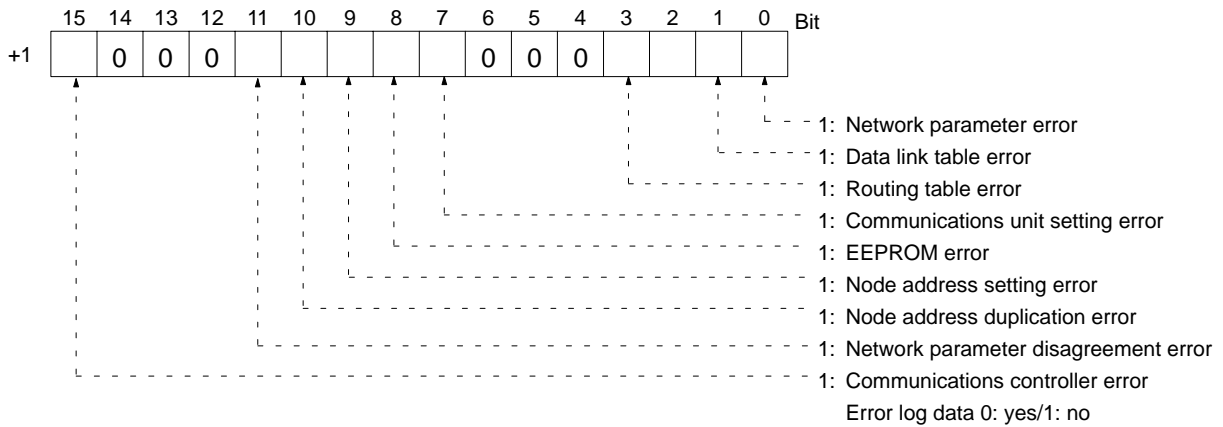

Network Status (Refer to Section 3)

Word: 1500 + (25 x unit no.) + 2 to 7

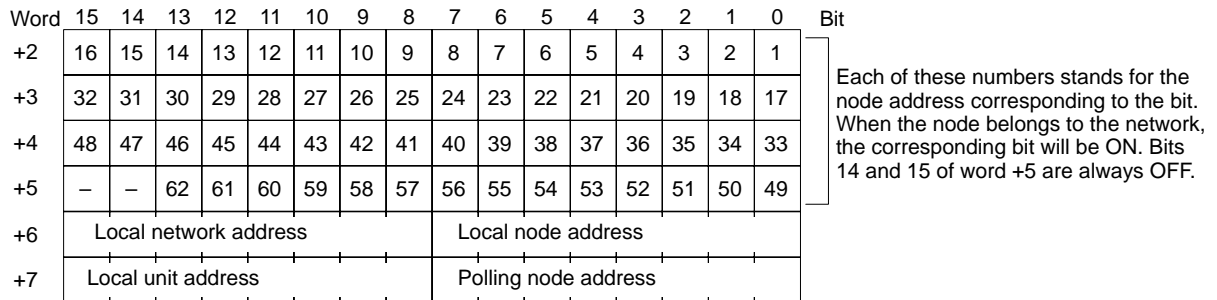

Data Link Status

Word: 1500 + (25 x unit no.) + 8 to 23

Word	15	14	13	12	11	10	9	8	7	6	5	4	3	2	1	0	Bit
+8	4th				3rd				2nd				1st				
+9	8th				7th				6th				5th				
+10	12th				11th				10th				9th				
+11	16th				15th				14th				13th				
+12	20th				19th				18th				17th				
+13	24th				23rd				22nd				21st				
+14	28th				27th				26th				25th				
+15	32nd				31st				30th				29th				
+16	36th				35th				34th				33rd				
+17	40th				39th				38th				37th				
+18	44th				43rd				42nd				41st				
+19	48th				47th				46th				45th				
+20	52nd				51st				50th				49th				
+21	56th				55th				54th				53rd				
+22	60th				59th				58th				57th				
+23	0				Start node address				62nd				61st				

The configuration of the four-bit data, registered on the data link table (refresh parameters) in order, expresses the status of each node as follows:

Status of each node

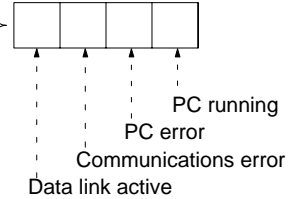

Local node data link operation flag
 0: Stopped
 1: Active

Test and Power Supply

Word: 1500 + (25 x unit no.) + 24

Word	15	14	13	12	11	10	9	8	7	6	5	4	3	2	1	0	Bit
+24	0	0	0	0		0	0	0	0	0	0	0	0	0	0		

0: No power supplied
 1: Power supplied (CC500-SLK11 only)

0: Test between nodes not executing
 1: Test between nodes being executed

Appendix E

Setting and Startup Procedures

Setting Procedure

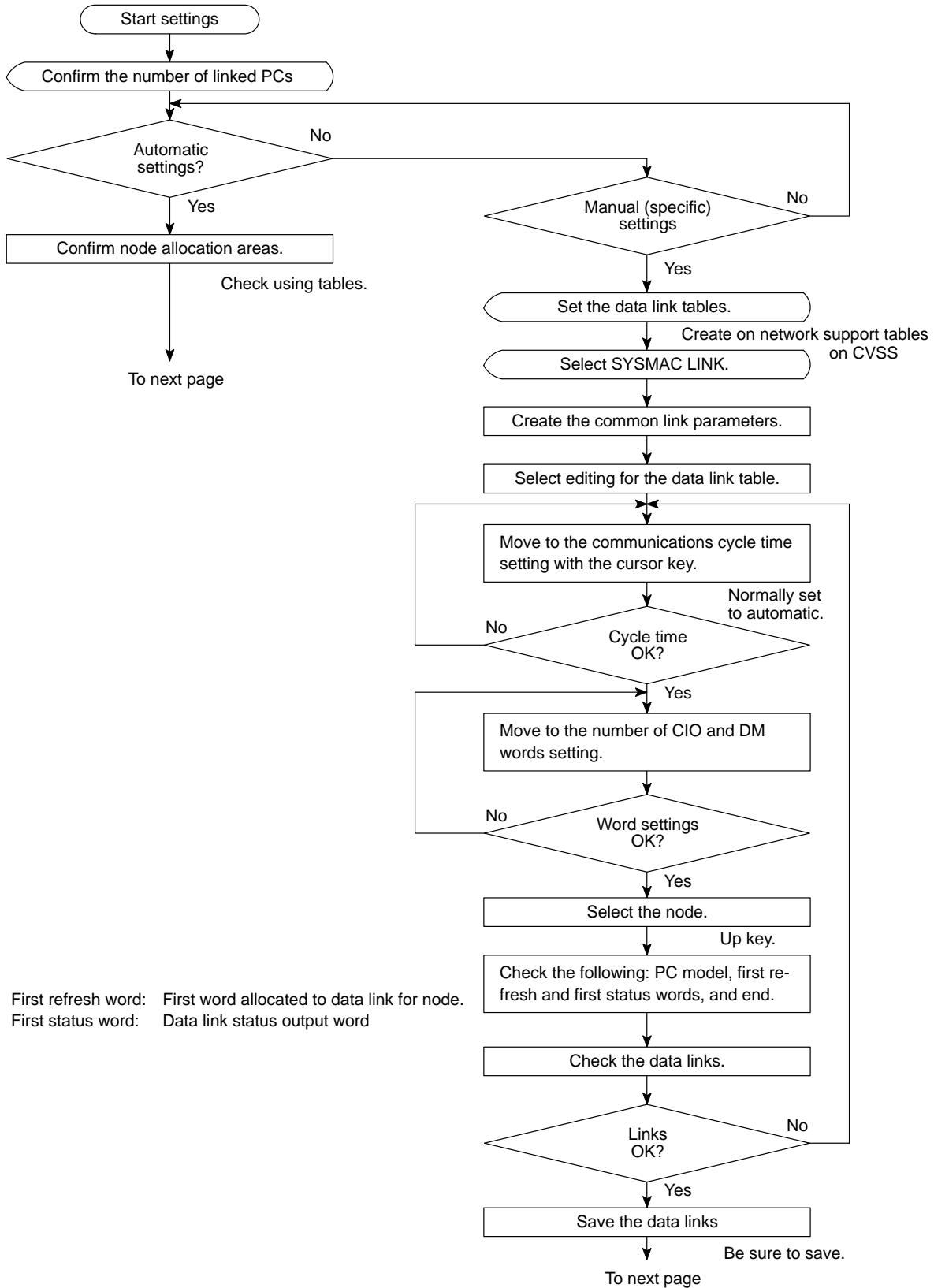

First refresh word: First word allocated to data link for node.
 First status word: Data link status output word

From previous page

From previous page

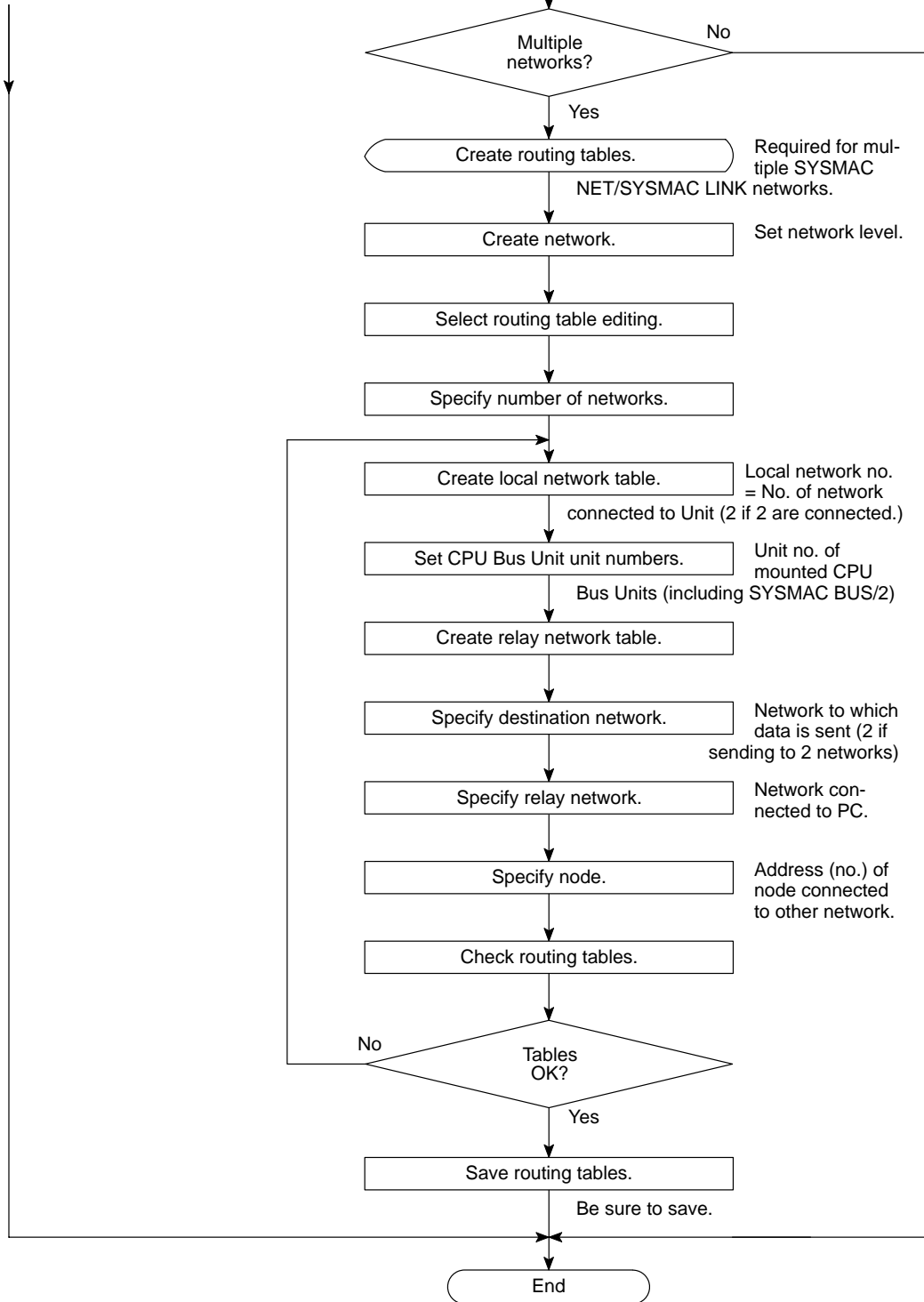

Startup Procedure

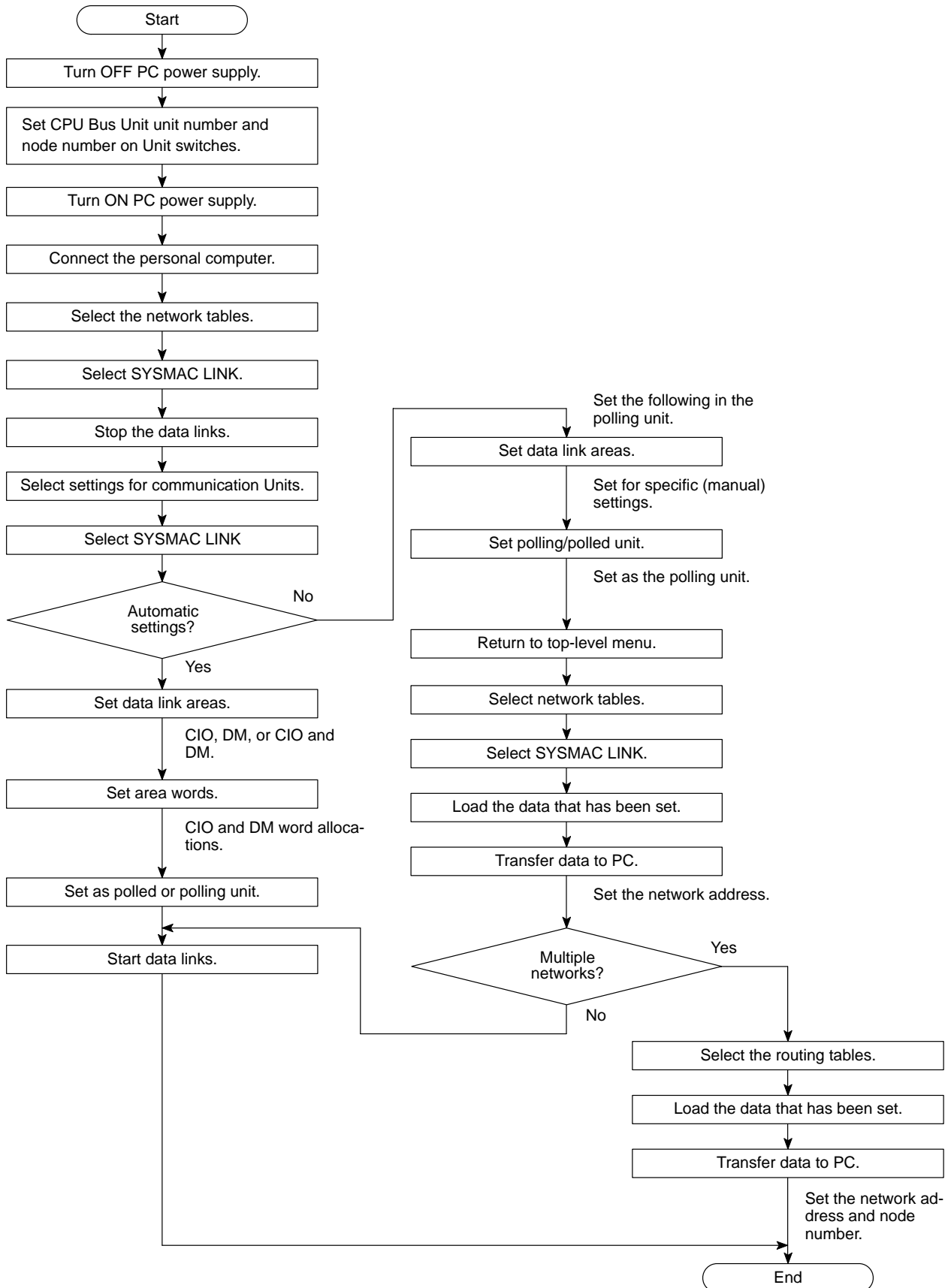

Glossary

address	A number used to identify the location of data or programming instructions in memory or to identify the location of a network or a unit in a network.
advanced instruction	An instruction input with a function code that handles data processing operations within ladder diagrams, as opposed to a basic instruction, which makes up the fundamental portion of a ladder diagram.
allocation	The process by which the PC assigns certain bits or words in memory for various functions. This includes pairing I/O bits to I/O points on Units.
analog	Something that represents or can process a continuous range of values as opposed to values that can be represented in distinct increments. Something that represents or can process values represented in distinct increments is called digital.
Analog I/O Unit	I/O Units that convert I/O between analog and digital values. An Analog Input Unit converts an analog input to a digital value for processing by the PC. An Analog Output Unit converts a digital value to an analog output.
AND	A logic operation whereby the result is true if and only if both premises are true. In ladder-diagram programming the premises are usually ON/OFF states of bits or the logical combination of such states called execution conditions.
area	See <i>data area</i> and <i>memory area</i> .
area prefix	A one or two letter prefix used to identify a memory area in the PC. All memory areas except the CIO area require prefixes to identify addresses in them.
ASCII	Short for American Standard Code for Information Interchange. ASCII is used to code characters for output to printers and other external devices.
asynchronous execution	Execution of programs and servicing operations in which program execution and servicing are not synchronized with each other.
Auxiliary Area	A PC data area allocated to flags and control bits.
auxiliary bit	A bit in the Auxiliary Area.
back-up	A copy made of existing data to ensure that the data will not be lost even if the original data is corrupted or erased.
BASIC	A common programming language. BASIC Units are programmed in BASIC.
basic instruction	A fundamental instruction used in a ladder diagram. See <i>advanced instruction</i> .
BASIC Unit	A CPU Bus Unit used to run programs in BASIC.
baud rate	The data transmission speed between two devices in a system measured in bits per second.
BCD	Short for binary-coded decimal.
binary	A number system where all numbers are expressed in base 2, i.e., numbers are written using only 0's and 1's. Each group of four binary bits is equivalent to one

	hexadecimal digit. Binary data in memory is thus often expressed in hexadecimal for convenience.
binary-coded decimal	A system used to represent numbers so that every four binary bits is numerically equivalent to one decimal digit.
bit	The smallest piece of information that can be represented on a computer. A bit has the value of either zero or one, corresponding to the electrical signals ON and OFF. A bit represents one binary digit. Some bits at particular addresses are allocated to special purposes, such as holding the status of input from external devices, while other bits are available for general use in programming.
bit address	The location in memory where a bit of data is stored. A bit address specifies the data area and word that is being addressed as well as the number of the bit within the word.
Branching Link Adapter	A Link Adapter used to branch connections to Units in a Link System used either to prevent the entire System from shutting down for an interruption at only one point in the System or to enable connecting more than two Units in one System when each Unit provides only one connector.
buffer	A temporary storage space for data in a computerized device.
building-block PC	A PC that is constructed from individual components, or "building blocks." With building-block PCs, there is no one Unit that is independently identifiable as a PC. The PC is rather a functional assembly of Units.
bus	A communications path used to pass data between any of the Units connected to it.
bus link	A data link that passed data between two Units across a bus.
byte	A unit of data equivalent to 8 bits, i.e., half a word.
central processing unit	A device that is capable of storing programs and data, and executing the instructions contained in the programs. In a PC System, the central processing unit executes the program, processes I/O signals, communicates with external devices, etc.
channel	See <i>word</i> .
character code	A numeric (usually binary) code used to represent an alphanumeric character.
checksum	A sum transmitted with a data pack in communications. The checksum can be recalculated from the received data to confirm that the data in the transmission has not been corrupted.
CIM	Computer integrated manufacturing; a process where one or more computers are used to control and integrate manufacturing processes.
CIO Area	A memory area used to control I/O and to store and manipulate data. CIO Area addresses do not require prefixes.
combined Link System	A control system that includes more than one of the following systems: Remote I/O System, SYSMAC Link System, Host Link System, or SYSMAC NET Link System.
common (link) parameter table	A table of settings in a SYSMAC LINK System that specifies what words are to be used in the data links for all PCs in the SYSMAC LINK System. See <i>refresh parameter table</i> .

common data	Data that is stored in a memory of a PC and which is shared by other PCs in the same the same system. Each PC has a specified section(s) of the area allocated to it. Each PC writes to the section(s) allocated to it and reads the sections allocated to the other PCs with which it shares the common data.
constant	An input for an operand in which the actual numeric value is specified. Constants can be input for certain operands in place of memory area addresses. Some operands must be input as constants.
control bit	A bit in a memory area that is set either through the program or via a Programming Device to achieve a specific purpose, e.g., a Restart Bit is turned ON and OFF to restart a Unit.
control signal	A signal sent from the PC to effect the operation of the controlled system.
Control System	All of the hardware and software components used to control other devices. A Control System includes the PC System, the PC programs, and all I/O devices that are used to control or obtain feedback from the controlled system.
controlled system	The devices that are being controlled by a PC System.
CPU	See <i>central processing unit</i> .
CPU Bus Unit	A special Unit used with CV-series PCs that mounts to the CPU bus. This connection to the CPU bus enables special data links, data transfers, and processing.
CPU Rack	The main Rack in a building-block PC, the CPU Rack contains the CPU, a Power Supply, and other Units. The CPU Rack, along with the Expansion CPU Rack, provides both an I/O bus and a CPU bus.
C-series PC	Any of the following PCs: C2000H, C1000H, C500, C200H, C40H, C28H, C20H, C60K, C60P, C40K, C40P, C28K, C28P, C20K, C20P, C120, or C20.
CTS	An acronym for clear-to-send, a signal used in communications between electronic devices to indicate that the receiver is ready to accept incoming data.
CV Support Software	A programming package run on an IBM PC/AT or compatible to serve as a Programming Device for CV-series PCs.
CV-mode	A form of communications useable only with CV-series PCs. See <i>C-mode</i> .
CV-series PC	Any of the following PCs: CV500, CV1000, CV2000, or CVM1
CVSS	See <i>CV Support Software</i> .
cycle	One unit of processing performed by the CPU, including SFC/ladder program execution, peripheral servicing, I/O refreshing, etc. The cycle is called the scan with C-series PCs.
cycle time	The time required to complete one cycle of CPU processing.
data area	An area in the PC's memory that is designed to hold a specific type of data.
data length	In communications, the number of bits that is to be treated as one unit in data transmissions.
data link	An automatic data transmission operation that allows PCs or Units within PC to pass data back and forth via common data areas.

data link area	A common data area established through a data link.
data link table	A table of settings kept in memory that specifies what words are to be part of a data link for all PCs involved in the link.
data register	A storage location in memory used to hold data. In CV-series PCs, data registers are used with or without index registers to hold data used in indirect addressing.
data sharing	An aspect of SYSMAC Link Systems and SYSMAC NET Link Systems in which common data areas or common data words are created between two or more PCs.
data transfer	Moving data from one memory location to another, either within the same device or between different devices connected via a communications line or network.
debug	A process by which a draft program is corrected until it operates as intended. Debugging includes both the removal of syntax errors, as well as the fine-tuning of timing and coordination of control operations.
decimal	A number system where numbers are expressed to the base 10. In a PC all data is ultimately stored in binary form, four binary bits are often used to represent one decimal digit, via a system called binary-coded decimal.
decrement	Decreasing a numeric value, usually by 1.
default	A value automatically set by the PC when the user does not specifically set another value. Many devices will assume such default conditions upon the application of power.
delimiter	A code sent during communications between devices to indicate the end of the current transmission, but not the end of the entire transmission. See <i>terminator</i> .
destination	The location where an instruction places the data on which it is operating, as opposed to the location from which data is taken for use in the instruction. The location from which data is taken is called the source.
digit	A unit of storage in memory that consists of four bits.
DIP switch	Dual in-line package switch, an array of pins in a signal package that is mounted to a circuit board and is used to set operating parameters.
distributed control	A automation concept in which control of each portion of an automated system is located near the devices actually being controlled, i.e., control is decentralized and 'distributed' over the system. Distributed control is a concept basic to PC Systems.
DM Area	A data area used to hold only word data. Words in the DM area cannot be accessed bit by bit.
DM word	A word in the DM Area.
downloading	The process of transferring a program or data from a higher-level or host computer to a lower-level or slave computer. If a Programming Device is involved, the Programming Device is considered the host computer.
EEPROM	Electrically erasable programmable read-only memory; a type of ROM in which stored data can be erased and reprogrammed. This is accomplished using a

	special control lead connected to the EEPROM chip and can be done without having to remove the EEPROM chip from the device in which it is mounted.
electrical noise	Random variations of one or more electrical characteristics such as voltage, current, and data, which might interfere with the normal operation of a device.
EM Area	Extended Data Memory Area; an area that can be optionally added to certain PCs to enable greater data storage. Functionally, the EM Area operates like the DM Area. Area addresses are prefixed with E and only words can be accessed. The EM Area is separated into multiple banks.
EPROM	Erasable programmable read-only memory; a type of ROM in which stored data can be erased, by ultraviolet light or other means, and reprogrammed.
error code	A numeric code generated to indicate that an error exists, and something about the nature of the error. Some error codes are generated by the system; others are defined in the program by the operator.
even parity	A communication setting that adjusts the number of ON bits so that it is always even. See <i>parity</i> .
event processing	Processing that is performed in response to an event, e.g., an interrupt signal.
Expansion CPU Rack	A Rack connected to the CPU Rack to increase the virtual size of the CPU Rack. Units that may be mounted to the CPU Backplane may also be mounted to the Expansion CPU Backplane.
Expansion I/O Rack	A Rack used to increase the I/O capacity of a PC. In CV-Series PC, either one Expansion I/O Rack can be connected directly to the CPU or Expansion CPU Rack or multiple Expansion I/O Racks can be connected by using an I/O Control and I/O Interface Units.
FA	Factory automation.
factory computer	A general-purpose computer, usually quite similar to a business computer, that is used in automated factory control.
fatal error	An error that stops PC operation and requires correction before operation can continue.
FCS	See <i>frame checksum</i> .
FINS	See <i>CV-mode</i> .
flag	A dedicated bit in memory that is set by the system to indicate some type of operating status. Some flags, such as the carry flag, can also be set by the operator or via the program.
force reset	The process of forcibly turning OFF a bit via a programming device. Bits are usually turned OFF as a result of program execution.
force set	The process of forcibly turning ON a bit via a programming device. Bits are usually turned ON as a result of program execution.
frame checksum	The results of exclusive ORing all data within a specified calculation range. The frame checksum can be calculated on both the sending and receiving end of a data transfer to confirm that data was transmitted correctly.

GPC	An acronym for Graphic Programming Console.
Graphic Programming Console	A programming device with advanced programming and debugging capabilities to facilitate PC operation. A Graphic Programming Console is provided with a large display onto which ladder-diagram programs can be written directly in ladder-diagram symbols for input into the PC without conversion to mnemonic form.
handshaking	The process whereby two devices exchange basic signals to coordinate communications between them.
header code	A code in an instruction that specifies what the instruction is to do.
hexadecimal	A number system where all numbers are expressed to the base 16. In a PC all data is ultimately stored in binary form, however, displays and inputs on Programming Devices are often expressed in hexadecimal to simplify operation. Each group of four binary bits is numerically equivalent to one hexadecimal digit.
host interface	An interface that allows communications with a host computer.
Host Link System	A system with one or more host computers connected to one or more PCs via Host Link Units or host interfaces so that the host computer can be used to transfer data to and from the PC(s). Host Link Systems enable centralized management and control of PC Systems.
Host Link Unit	An interface used to connect a C-series PC to a host computer in a Host Link System.
I/O allocation	The process by which the PC assigns certain bits in memory for various functions. This includes pairing I/O bits to I/O points on Units.
I/O Block	Either an Input Block or an Output Block. I/O Blocks provide mounting positions for replaceable relays.
I/O Control Unit	A Unit mounted to the CPU Rack to monitor and control I/O points on Expansion CPU Racks or Expansion I/O Racks.
I/O delay	The delay in time from when a signal is sent to an output to when the status of the output is actually in effect or the delay in time from when the status of an input changes until the signal indicating the change in the status is received.
I/O device	A device connected to the I/O terminals on I/O Units, Special I/O Units, etc. I/O devices may be either part of the Control System, if they function to help control other devices, or they may be part of the controlled system.
I/O Interface Unit	A Unit mounted to an Expansion CPU Rack or Expansion I/O Rack to interface the Rack to the CPU Rack.
I/O point	The place at which an input signal enters the PC System, or at which an output signal leaves the PC System. In physical terms, I/O points correspond to terminals or connector pins on a Unit; in terms of programming, an I/O points correspond to I/O bits in the IR area.
I/O refreshing	The process of updating output status sent to external devices so that it agrees with the status of output bits held in memory and of updating input bits in memory so that they agree with the status of inputs from external devices.
I/O response time	The time required for an output signal to be sent from the PC in response to an input signal received from an external device.

I/O Terminal	A Remote I/O Unit connected in a Wired Remote I/O System to provide a limited number of I/O points at one location. There are several types of I/O Terminals.
I/O Unit	The most basic type of Unit mounted to a Backplane. I/O Units include Input Units and Output Units, each of which is available in a range of specifications. I/O Units do not include Special I/O Units, Link Units, etc.
I/O verification error	A error generated by a disagreement between the Units registered in the I/O table and the Units actually mounted to the PC.
I/O word	A word in the CIO area that is allocated to a Unit in the PC System and is used to hold I/O status for that Unit.
IBM PC/AT or compatible	A computer that has similar architecture to, that is logically compatible with, and that can run software designed for an IBM PC/AT computer.
initialize	Part of the startup process whereby some memory areas are cleared, system setup is checked, and default values are set.
input	The signal coming from an external device into the PC. The term input is often used abstractly or collectively to refer to incoming signals.
input bit	A bit in the CIO area that is allocated to hold the status of an input.
Input Block	A Unit used in combination with a Remote Interface to create an I/O Terminal. An Input Block provides mounting positions for replaceable relays. Each relay can be selected according to specific input requirements.
input device	An external device that sends signals into the PC System.
input point	The point at which an input enters the PC System. Input points correspond physically to terminals or connector pins.
input signal	A change in the status of a connection entering the PC. Generally an input signal is said to exist when, for example, a connection point goes from low to high voltage or from a nonconductive to a conductive state.
Input Terminal	An I/O Terminal that provides input points.
instruction	A direction given in the program that tells the PC of the action to be carried out, and the data to be used in carrying out the action. Instructions can be used to simply turn a bit ON or OFF, or they can perform much more complex actions, such as converting and/or transferring large blocks of data.
interface	An interface is the conceptual boundary between systems or devices and usually involves changes in the way the communicated data is represented. Interface devices such as NSBs perform operations like changing the coding, format, or speed of the data.
interrupt (signal)	A signal that stops normal program execution and causes a subroutine to be run or other processing to take place.
Interrupt Input Unit	A Rack-mounting Unit used to input external interrupts into a PC System.
IOIF	An acronym for I/O Interface Unit.
IOM (Area)	A collective memory area containing all of the memory areas that can be accessed by bit, including timer and counter Completion Flags. The IOM Area includes all memory area memory addresses between 0000 and 0FFF.

JIS	An acronym for Japanese Industrial Standards.
jump	A type of programming where execution moves directly from one point in a program to another, without sequentially executing any instructions in between. Jumps in ladder diagrams are usually conditional on an execution condition; jumps in SFC programs are conditional on the step status and transition condition status before the jump.
LAN	An acronym for local area network.
least-significant (bit/word)	See <i>rightmost (bit/word)</i> .
LED	Acronym for light-emitting diode; a device used as for indicators or displays.
leftmost (bit/word)	The highest numbered bits of a group of bits, generally of an entire word, or the highest numbered words of a group of words. These bits/words are often called most-significant bits/words.
link	A hardware or software connection formed between two Units. "Link" can refer either to a part of the physical connection between two Units or a software connection created to data existing at another location (i.e., data links).
link parameter table	See <i>common link parameter table</i> .
Link System	A system used to connect remote I/O or to connect multiple PCs in a network. Link Systems include the following: SYSMAC BUS Remote I/O Systems, SYSMAC BUS/2 Remote I/O Systems, SYSMAC LINK Systems, Host Link Systems, and SYSMAC NET Link Systems.
Link Unit	Any of the Units used to connect a PC to a Link System. These include Remote I/O Units, SYSMAC LINK Units, and SYSMAC NET Link Units.
load	The processes of copying data either from an external device or from a storage area to an active portion of the system such as a display buffer. Also, an output device connected to the PC is called a load.
local area network	A network consisting of nodes or positions in a loop arrangement. Each node can be any one of a number of devices. This kind of network usually operates over a small area such as a group of offices or a factory floor.
local network table	A table that specifies all of the networks that a PC belongs to and the unit numbers of the Units connecting the PC to each of these networks.
master	In a SYSMAC NET Link System, a Unit specified to manage network communications.
master number	A number assigned to a master in a SYSMAC NET Link System. This number is different from the unit number.
MCR Unit	Magnetic Card Reader Unit.
megabyte	A unit of storage equal to one million bytes.
memory area	Any of the areas in the PC used to hold data or programs.
most-significant (bit/word)	See <i>leftmost (bit/word)</i> .
nesting	Programming one loop within another loop, programming a call to a subroutine within another subroutine, or programming an IF–ELSE programming section within another IF–ELSE section.

Network Service Board	A device with an interface to connect devices other than PCs to a SYSMAC NET Link System.
Network Service Unit	A Unit that provides two interfaces to connect peripheral devices to a SYSMAC NET Link System.
network support table	Tables of settings used to establish operating parameters for SYSMAC LINK and SYSMAC NET Link Systems.
node	One of the positions in a LAN. Each node incorporates a device that can communicate with the devices at all of the other nodes. The device at a node is identified by the node number.
node number	A number used to identify a node on a network. The node number of a CV-series PC is called the "unit number" in the PC Setup.
noise interference	Disturbances in signals caused by electrical noise.
nonfatal error	A hardware or software error that produces a warning but does not stop the PC from operating.
NOT	A logic operation which inverts the status of the operand. For example, AND NOT indicates an AND operation with the opposite of the actual status of the operand bit.
NSB	An acronym for Network Service Board.
NSU	An acronym for Network Service Unit.
octal	A number system where all numbers are expressed in base 8, i.e., numbers are written using only numerals 0 through 7.
odd parity	A communications setting that adjusts the number of ON bits so that it is always odd. See <i>parity</i> .
OFF	The status of an input or output when a signal is said not to be present. The OFF state is generally represented by a low voltage or by non-conductivity, but can be defined as the opposite of either.
OFF delay	The delay between the time when a signal is switched OFF (e.g., by an input device or PC) and the time when the signal reaches a state readable as an OFF signal (i.e., as no signal) by a receiving party (e.g., output device or PC).
offset	A positive or negative value added to a base value such as an address to specify a desired value.
ON	The status of an input or output when a signal is said to be present. The ON state is generally represented by a high voltage or by conductivity, but can be defined as the opposite of either.
ON delay	The delay between the time when an ON signal is initiated (e.g., by an input device or PC) and the time when the signal reaches a state readable as an ON signal by a receiving party (e.g., output device or PC).
operand	The values designated as the data to be used for an instruction. An operand can be input as a constant expressing the actual numeric value to be used or as an address to express the location in memory of the data to be used.

operating error	An error that occurs during actual PC operation as opposed to an initialization error, which occurs before actual operations can begin.
optical communications	A communications method in which signals are sent over optical fiber cable to prevent noise interference and increase transmission distance.
OR	A logic operation whereby the result is true if either of two premises is true, or if both are true. In ladder-diagram programming the premises are usually ON/OFF states of bits or the logical combination of such states called execution conditions.
output	The signal sent from the PC to an external device. The term output is often used abstractly or collectively to refer to outgoing signals.
Output Block	A Unit used in combination with a Remote Interface to create an I/O Terminal. An Output Block provides mounting positions for replaceable relays. Each relay can be selected according to specific output requirements.
output device	An external device that receives signals from the PC System.
output point	The point at which an output leaves the PC System. Output points correspond physically to terminals or connector pins.
output signal	A signal being sent to an external device. Generally an output signal is said to exist when, for example, a connection point goes from low to high voltage or from a nonconductive to a conductive state.
Output Terminal	An I/O Terminal that provides output points.
overflow	The state where the capacity of a data storage location has been exceeded.
overwrite	Changing the content of a memory location so that the previous content is lost.
parity	Adjustment of the number of ON bits in a word or other unit of data so that the total is always an even number or always an odd number. Parity is generally used to check the accuracy of data after being transmitted by confirming that the number of ON bits is still even or still odd.
parity check	Checking parity to ensure that transmitted data has not been corrupted.
PC	An acronym for Programmable Controller.
PC configuration	The arrangement and interconnections of the Units that are put together to form a functional PC.
PC System	With building-block PCs, all of the Racks and independent Units connected directly to them up to, but not including the I/O devices. The boundaries of a PC System are the PC and the program in its CPU at the upper end; and the I/O Units, Special I/O Units, Optical I/O Units, Remote Terminals, etc., at the lower end.
PCB	An acronym for printed circuit board.
PC Setup	A group of operating parameters set in the PC from a Programming Device to control PC operation.
Peripheral Device	Devices connected to a PC System to aid in system operation. Peripheral devices include printers, programming devices, external storage media, etc.

peripheral servicing	Processing signals to and from peripheral devices, including refreshing, communications processing, interrupts, etc.
PID Unit	A Unit designed for PID control.
polling	The process whereby a devices consecutively sends signals to other devices in the same network to pass data back and forth, e.g., as in a data link.
present value	The current value registered in a device at any instant during its operation. Present value is abbreviated as PV. The use of this term is generally restricted to timers and counters.
printed circuit board	A board onto which electrical circuits are printed for mounting into a computer or electrical device.
Programmable Controller	A computerized device that can accept inputs from external devices and generate outputs to external devices according to a program held in memory. Programmable Controllers are used to automate control of external devices. Although single-unit Programmable Controllers are available, building-block Programmable Controllers are constructed from separate components. Such Programmable Controllers are formed only when enough of these separate components are assembled to form a functional assembly, i.e., there is no one individual Unit called a PC.
Programming Console	The simplest form of programming device available for a PC. Programming Consoles are available both as hand-held models and as CPU-mounting models.
Programming Device	A Peripheral Device used to input a program into a PC or to alter or monitor a program already held in the PC. There are dedicated programming devices, such as Programming Consoles, and there are non-dedicated devices, such as a host computer.
PROM	Programmable read-only memory; a type of ROM into which the program or data may be written after manufacture, by a customer, but which is fixed from that time on.
PROM Writer	A peripheral device used to write programs and other data into a ROM for permanent storage and application.
prompt	A message or symbol that appears on a display to request input from the operator.
protocol	The parameters and procedures that are standardized to enable two devices to communicate or to enable a programmer or operator to communicate with a device.
PV	See <i>present value</i> .
Rack	An assembly that forms a functional unit in a Rack PC System. A Rack consists of a Backplane and the Units mounted to it. These Units include the Power Supply, CPU, and I/O Units. Racks include CPU Racks, Expansion I/O Racks, and I/O Racks. The CPU Rack is the Rack with the CPU mounted to it. An Expansion I/O Rack is an additional Rack that holds extra I/O Units. An I/O Rack is used in the C2000H Duplex System, because there is no room for any I/O Units on the CPU Rack in this System.
rack number	A number assigned to a Rack according to the order that it is connected to the CPU Rack, with the CPU Rack generally being rack number 0.

Rack PC	A PC that is composed of Units mounted to one or more Racks. This configuration is the most flexible, and most large PCs are Rack PCs. A Rack PC is the opposite of a Package-type PC, which has all of the basic I/O, storage, and control functions built into a single package.
RAM	Random access memory; a data storage media. RAM will not retain data when power is disconnected.
RAS	An acronym for reliability, assurance, safety.
refresh	The process of updating output status sent to external devices so that it agrees with the status of output bits held in memory and of updating input bits in memory so that they agree with the status of inputs from external devices.
refresh parameter (table)	A table of settings that specifies which words in the data links for a System are to be refreshed for a particular PC. See <i>common link parameter table</i> .
relay-based control	The forerunner of PCs. In relay-based control, groups of relays are interconnected to form control circuits. In a PC, these are replaced by programmable circuits.
reserved bit	A bit that is not available for user application.
reserved word	A word in memory that is reserved for a special purpose and cannot be accessed by the user.
reset	The process of turning a bit or signal OFF or of changing the present value of a timer or counter to its set value or to zero.
response code	A code sent with the response to a data transmission that specifies how the transmitted data was processed.
response format	A format specifying the data required in a response to a data transmission.
Restart Bit	A bit used to restart a Unit mounted to a PC.
restart continuation	A process which allows memory and program execution status to be maintained so that PC operation can be restarted from the state it was in when operation was stopped by a power interruption.
retrieve	The processes of copying data either from an external device or from a storage area to an active portion of the system such as a display buffer. Also, an output device connected to the PC is called a load.
retry	The process whereby a device will re-transmit data which has resulted in an error message from the receiving device.
rightmost (bit/word)	The lowest numbered bits of a group of bits, generally of an entire word, or the lowest numbered words of a group of words. These bits/words are often called least-significant bits/words.
rising edge	The point where a signal actually changes from an OFF to an ON status.
ROM	Read only memory; a type of digital storage that cannot be written to. A ROM chip is manufactured with its program or data already stored in it and can never be changed. However, the program or data can be read as many times as desired.

routing table	Tables of setting that specify what networks a device is a member of and what nodes must be passed through to reach other specific networks. See <i>local network table</i> and <i>relay network table</i> .
RS-232C interface	An industry standard for serial communications.
RS-422 interface	An industry standard for serial communications.
scan	The process used to execute a ladder-diagram program. The program is examined sequentially from start to finish and each instruction is executed in turn based on execution conditions. The scan also includes peripheral processing, I/O refreshing, etc. The scan is called the cycle with CV-series PCs.
scan time	The time required for a single scan of a ladder-diagram program.
self diagnosis	A process whereby the system checks its own operation and generates a warning or error if an abnormality is discovered.
series	A wiring method in which Units are wired consecutively in a string. In Link Systems wired through Link Adapters, the Units are still functionally wired in series, even though Units are placed on branch lines.
servicing	The process whereby the PC provides data to or receives data from external devices or remote I/O Units, or otherwise handles data transactions for Link Systems.
set	The process of turning a bit or signal ON.
set value	The value from which a decrementing counter starts counting down or to which an incrementing counter counts up (i.e., the maximum count), or the time from which or for which a timer starts timing. Set value is abbreviated SV.
software error	An error that originates in a software program.
software protect	A means of protecting data from being changed that uses software as opposed to a physical switch or other hardware setting.
software switch	See <i>memory switch</i> .
Special I/O Unit	A Unit that is designed for a specific purpose. Special I/O Units include Position Control Units, High-speed Counter Units, Analog I/O Units, etc.
SRAM	Static random access memory; a data storage media.
subroutine	A group of instructions placed separate from the main program and executed only when called from the main program or activated by an interrupt.
SV	Abbreviation for set value.
synchronous execution	Execution of programs and servicing operations in which program execution and servicing are synchronized so that all servicing operations are executed each time the programs are executed.
syntax	The form of a program statement (as opposed to its meaning). For example, the two statements, <code>LET A=B+B</code> and <code>LET A=B*2</code> use different syntaxes, but have the same meaning.
syntax error	An error in the way in which a program is written. Syntax errors can include 'spelling' mistakes (i.e., a function code that does not exist), mistakes in specifying

ing operands within acceptable parameters (e.g., specifying read-only bits as a destination), and mistakes in actual application of instructions (e.g., a call to a subroutine that does not exist).

SYSMAC LINK System	A communications system used to create data links and enable network communications between PCs.
SYSMAC NET Link System	An optical LAN formed from PCs connected through SYSMAC NET Link Units. A SYSMAC NET Link System also normally contains nodes interfacing computers and other peripheral devices. PCs in the SYSMAC NET Link System can pass data back and forth, receive commands from any interfaced computer, and share any interfaced peripheral device.
SYSMAC NET Link Unit	The Unit used to connect PCs to a SYSMAC NET Link System.
system configuration	The arrangement in which Units in a System are connected. This term refers to the conceptual arrangement and wiring together of all the devices needed to comprise the System. In OMRON terminology, system configuration is used to describe the arrangement and connection of the Units comprising a Control System that includes one or more PCs.
system error	An error generated by the system, as opposed to one resulting from execution of an instruction designed to generate an error.
system error message	An error message generated by the system, as opposed to one resulting from execution of an instruction designed to generate a message.
terminator	The code comprising an asterisk and a carriage return (* CR) which indicates the end of a block of data in communications between devices. Frames within a multi-frame block are separated by delimiters. Also a Unit in a Link System designated as the last Unit on the communications line.
timer	A location in memory accessed through a TC bit and used to time down from the timer's set value. Timers are turned ON and reset according to their execution conditions.
TR Area	A data area used to store execution conditions so that they can be reloaded later for use with other instructions.
TR bit	A bit in the TR Area.
transfer	The process of moving data from one location to another within the PC, or between the PC and external devices. When data is transferred, generally a copy of the data is sent to the destination, i.e., the content of the source of the transfer is not changed.
transmission distance	The distance that a signal can be transmitted.
UM area	The memory area used to hold the active program, i.e., the program that is being currently executed.
Unit	In OMRON PC terminology, the word Unit is capitalized to indicate any product sold for a PC System. Though most of the names of these products end with the word Unit, not all do, e.g., a Remote Terminal is referred to in a collective sense as a Unit. Context generally makes any limitations of this word clear.
unit address	A number used to control network communications. Unit addresses are computed for Units in various ways, e.g., 10 hex is added to the unit number to determine the unit address for a CPU Bus Unit.

Glossary

unit number	A number assigned to some Link Units, Special I/O Units, and CPU Bus Units to facilitate identification when assigning words or other operating parameters.
uploading	The process of transferring a program or data from a lower-level or slave computer to a higher-level or host computer. If a Programming Device is involved, the Programming Device is considered the host computer.
watchdog timer	A timer within the system that ensures that the scan time stays within specified limits. When limits are reached, either warnings are given or PC operation is stopped depending on the particular limit that is reached.
WDT	See <i>watchdog timer</i> .
wire communications	A communications method in which signals are sent over wire cable. Although noise resistance and transmission distance can sometimes be a problem with wire communications, they are still the cheapest and the most common, and perfectly adequate for many applications.
word	A unit of data storage in memory that consists of 16 bits. All data areas consists of words. Some data areas can be accessed only by words; others, by either words or bits.
word address	The location in memory where a word of data is stored. A word address must specify (sometimes by default) the data area and the number of the word that is being addressed.
word allocation	The process of assigning I/O words and bits in memory to I/O Units and terminals in a PC System to create an I/O Table.
work area	A part of memory containing work words/bits.
work bit	A bit in a work word.
work word	A word that can be used for data calculation or other manipulation in programming, i.e., a 'work space' in memory. A large portion of the IR area is always reserved for work words. Parts of other areas not required for special purposes may also be used as work words.
write protect switch	A switch used to write-protect the contents of a storage device, e.g., a floppy disk. If the hole on the upper left of a floppy disk is open, the information on this floppy disk cannot be altered.
write-protect	A state in which the contents of a storage device can be read but cannot be altered.

Index

A

- access right
 - acquiring CV-series PC's access right, 105 , 106
 - releasing CV-series PC's access right, 107
- automatic generation of data link tables, 34
- Auxiliary Area
 - reading contents of Auxiliary Area words, 84 , 87
 - writing to Auxiliary Area words, 85 , 86
- Auxiliary Power Supply Unit, 18

B

- bits, controlling
 - cancelling forced-set and forced-reset bits, 120
 - force-setting and force-resetting bits, 120
- broadcast test, 127 , 136
- broadcast transmission, definition, 65

C

- cables
 - Auxiliary Power Supply Unit, 19
 - connecting transmission cables, 14
- characteristics, data link, 46
- CIO Area, reading contents of CIO Area words, 84 , 87
- clock
 - reading CV-series clock, 102
 - setting CV-series clock, 103
- CMND(194), 65
- coaxial cable. *See* cables
- common link parameters, 36
- communications
 - specifications, 159
 - testing
 - broadcast test, 127 , 136
 - internode echo test, 127 , 132
 - token bus, 22
- communications cycle, 22
- communications cycle time, 25
 - data link, 46
- counters
 - changing PV, 85 , 86
 - reading Completion Flag status, 84 , 87
 - reading PV, 84 , 87
- CV-mode commands
 - command format, 80
 - command set
 - BROADCAST TEST DATA SEND, 128

- BROADCAST TEST RESULTS READ, 127
- CONTROLLER DATA READ, 122
- CONTROLLER STATUS READ, 122
- DATA LINK STATUS READ, 126
- INTERNODE ECHO TEST, 127
- NETWORK STATUS READ, 124
- errors, 143
 - for SYSMAC LINK Units, 121–129
 - response codes, errors, 143
 - response format, 80
- CV-mode command set
 - ACCESS RIGHT ACQUIRE, 105
 - ACCESS RIGHT FORCED ACQUIRE, 106
 - ACCESS RIGHT RELEASE, 107
 - CLOCK READ, 102
 - CLOCK WRITE, 103
 - CONNECTION DATA READ, 100
 - CONTROLLER DATA READ, 98
 - CONTROLLER STATUS READ, 100
 - CYCLE TIME READ, 102
 - DATA LINK START, 121
 - ERROR CLEAR, 107
 - ERROR LOG CLEAR, 109 , 129
 - ERROR LOG READ, 109 , 128
 - FAL/FALS READ, 105
 - FILE COPY, 114
 - FILE DATA CHECK, 115
 - FILE DELETE, 113
 - FILE NAME CHANGE, 115
 - FILE NAME READ, 110
 - FORCED SET/RESET, 120
 - FORCED SET/RESET CANCEL, 120
 - HALT DATA LINK, 121
 - MEMORY AREA FILE TRANSFER, 116
 - MEMORY AREA FILL, 86
 - MEMORY AREA READ, 84
 - MEMORY AREA TRANSFER, 88
 - MEMORY AREA WRITE, 85
 - MEMORY CARD FORMAT, 113
 - MESSAGE CLEAR, 104
 - MESSAGE READ, 103
 - MULTIPLE MEMORY AREA READ, 87
 - PARAMETER AREA CLEAR, 93
 - PARAMETER AREA FILE TRANSFER, 117
 - PARAMETER AREA READ, 89
 - PARAMETER AREA WRITE, 90
 - PROGRAM AREA CLEAR, 97
 - PROGRAM AREA FILE TRANSFER, 119
 - PROGRAM AREA PROTECT, 94
 - PROGRAM AREA PROTECT CLEAR, 95
 - PROGRAM AREA READ, 95
 - PROGRAM AREA WRITE, 96
 - RESET, 122
 - RUN, 97
 - SINGLE FILE READ, 111
 - SINGLE FILE WRITE, 112
 - STOP, 98
 - VOLUME LABEL CREATE/DELETE, 114
- cycle time, reading CV-series PC cycle time, 102

D

data link, 32 , 58
 characteristics, 46
 common link parameters, 36
 communications cycle time, 46
 controlling, 33
 creating, 34
 Data Link Status Flag, 44
 data link words, definition, 32
 errors, 148
 halting, 121
 maximum linked words, 27
 precautions, 43
 reading data link status, 126
 refresh parameters, 37
 refreshing, 35
 start-up node, 22
 starting, 121
 status flags, 44
 table back-up, 37
 tables
 automatic generation, 34
 definition, 32
 examples, 39
 manual generation, 36
 troubleshooting, 150

data read/write services, 65

delay times, 76

DM Area

 reading contents of DM Area words, 84 , 87
 writing to DM Area words, 85 , 86

E

EEPROM, write life, 66

errors

 clearing CV-series PC errors, 107
 clearing CV-series PC's error log, 109 , 129
 CV-mode commands, 143
 data link, 148
 LED indications, 142
 other, 148
 reading CV-series FAL/FALS messages, 105
 reading CV-series PC's error log, 109 , 128

F

files

 changing file names, 115
 checking data, 115
 checking file data against memory area data, 116
 checking file data against Parameter Area data, 117
 checking file data against program area data, 119
 copying, 114
 creating/deleting volume labels, 114
 deleting, 113

 reading data on number of files stored in file device, 110
 reading the contents of, 111
 transferring data, 116 , 117 , 119
 writing, 112

frames, maximum number, 26

H-I

handling precautions, 154

indicators, 9

 data link, 33
 error indications, 142

inspection, 154

 tools and equipment needed, 154

installation, 13 , 20

instruction set, PC

 CMND(194), 65
 RECV(193), 65
 SEND(192), 65

internode echo test, 127 , 132

L-M

LED indicator. *See* indicators

manual generation of data link tables, 36

maximum node address, 25

maximum number of frames, 26

Memory Areas

 comparing/transferring Memory Area data with file data, 116
 reading contents of Memory Area words, 84 , 87
 transferring data, 88
 writing to Memory Area words, 85 , 86

Memory Cards, formatting, 113

messages

 clearing CV-series MSG(195) messages, 104
 reading CV-series FAL/FALS messages, 105
 reading CV-series MSG(195) messages, 103

model numbers

 reading model numbers of specified Units, 100
 reading PC model number, 98 , 122

monitoring, remote, 132

N

network

 other OMRON network systems, 2
 reading network status, 124
 troubleshooting, 149

network parameters, 23 , 155

 setting, 25

number of polled units, 26

O—P

optical fiber cable. *See* cables

Parameter Areas

comparing/transferring Parameter Area data with file data, 117

reading contents of Parameter Area words, 89

writing to Parameter Area words, 90

writing zeroes to Parameter Area words, 93

PC

changing to PROGRAM mode, 98

changing to RUN mode, 97

reading CV-series PC cycle time, 102

reading CV-series PC status, 100 , 122

reading various CV-series PC data, 98 , 122

polled units, number, 26

polling cycle, definition, 22

polling unit, 4

definition, 22

precautions

general, xi

handling, 154

write life for C200H EEPROM, 66

program

clearing protection of the program area, 95

clearing the program area, 97

comparing/transferring program area data with file data, 119

protecting the program area, 94

reading contents of program area words, 95

writing to program area words, 96

programming, remote, 132

R

RECV (192), 65

RECV (98), delay time, 78

refresh of data link area, 35

remote monitoring, 132

remote programming, 132

resetting, SYSMAC LINK Unit, 122

S

SEND (90), delay time, 76

SEND(192), 65

write life for C200H EEPROM, 66

settings, overview, 167

specifications, 159

Auxiliary Power Supply Unit, 19

standard models, 157

start-up node, definition, 22

startup, overview, 169

status, data link, 44

switches, node address, setting, 24

SYSMAC LINK System

communications, 22

features, 2

flags, 164

multilevel, 5

number of PCs, 4

single-level system, 4

system configuration, 4

SYSMAC LINK Unit

components, C1000H–SLK11/SLK21–V1, 8

replacing, 154

SYSMAC NET Link System, flags, 164

T

test

broadcast, 127 , 136

internode echo, 127 , 132

timers

changing PV, 85 , 86

reading Completion Flag status, 84 , 87

reading PV, 84 , 87

token, definition, 22

token bus communications, definition, 22

token cycle, definition, 22

transmission cycle time

changing, 47

definition, 23

troubleshooting, 149

U—W

Units, reading the model numbers of connected Units, 100

volume labels, creating/deleting, 114

wiring, 20

