



MELSOFT

MR Configurator

MODEL

MRZJW3-SETUP221E

INSTALLATION GUIDE

Thank you for choosing the MELSOFT MR Configurator.
To optimize the use of the MR Configurator, please read over this Installation Guide and the corresponding AC servo Installation Guide before using the software. After reading the Installation Guide, always place this Installation Guide in a safe place.



● Safety Instructions ●

(Always read these instructions before using the equipment.)

Do not attempt to install, operate, maintain or inspect the servo amplifier and servo motor until you have read through this Installation Guide, and appended documents carefully and can use the equipment correctly. Do not use the servo amplifier and servo motor until you have a full knowledge of the equipment, safety information and instructions.

In this Installation Guide, the safety instruction levels are classified into "WARNING" and "CAUTION".



Indicates that incorrect handling may cause hazardous conditions, resulting in death or severe injury.



Indicates that incorrect handling may cause hazardous conditions, resulting in medium or slight injury to personnel or may cause physical damage.

Note that the CAUTION level may lead to a serious consequence according to conditions. Please follow the instructions of both levels because they are important to personnel safety.

What must not be done and what must be done are indicated by the following diagrammatic symbols:



: Indicates what must not be done. For example, "No Fire" is indicated by .



: Indicates what must be done. For example, grounding is indicated by .

In this Installation Guide, instructions at a lower level than the above, instructions for other functions, and so on are classified into "POINT".

After reading this Installation Guide, always keep it accessible to the operator.

- Windows is a trademark of Microsoft Corporation.
- The "Mitsubishi general-purpose AC servo MELSOFT MR Configurator" is a production of Mitsubishi Electric Corporation. Mitsubishi Electric Corporation reserves the copyright and all other rights of this software.
- This Installation Guide may not be reproduced or copied, in whole or part, without written consent of Mitsubishi Electric Corporation.
- All other company and product names contained in this Installation Guide are registered trademarks or trademarks of their respective companies.



▪ Before executing the test mode, always read Section 2.3 "Precaution for test mode".

CONTENTS

1. INTRODUCTION	1 - 1 to 1 -12
1.1 Specifications	1 - 1
1.2 System configuration	1 - 3
1.2.1 Components	1 - 3
1.2.2 Configuration	1 - 4
1.3 Basic terms.....	1 - 6
1.4 Installation procedure.....	1 - 7
1.5 New Hardware Detection Wizard	1 -10
2. HOW TO USE THE SOFTWARE	2 - 1 to 2 -10
2.1 Operation.....	2 - 1
2.1.1 Start-up	2 - 1
2.1.2 Project.....	2 - 1
2.2 Commands and display windows	2 - 3
2.3 Precautions for test mode	2 - 6
2.4 Simple language for program operation.....	2 - 8
2.4.1 Language.....	2 - 8
2.4.2 Program example	2 - 9
2.4.3 Instruction	2 - 9
3. TROUBLESHOOTING	3 - 1 to 3 - 4

1. INTRODUCTION

1. INTRODUCTION

1.1 Specifications

Using the communication function of the servo amplifier, the MR Configurator allows functions, such as parameter setting change, graph, program operation mode and test mode, to be implemented from a personal computer.

Item		Servo amplifier		MR-J3-B		MR-J3-B-RJ006		MR-J3-B-RJ004		MR-J3-T
		MR-J3-A		When connecting to the servo amplifier	When via a motion controller	When connecting to the servo amplifier	When via a motion controller	When connecting to the servo amplifier	When via a motion controller	
Communication method	USB		<input type="radio"/>	<input type="radio"/>	/	<input type="radio"/>	/	<input type="radio"/>	/	<input type="radio"/>
	RS-232C communication baud rate	9600bps	<input type="radio"/>	/	/	/	/	/	/	<input type="radio"/>
		19200bps	<input type="radio"/>	/	/	/	/	/	/	<input type="radio"/>
		38400bps	<input type="radio"/>	/	/	/	/	/	/	<input type="radio"/>
		57600bps	<input type="radio"/>	/	/	/	/	/	/	<input type="radio"/>
		115200bps	<input type="radio"/>	/	/	/	/	/	/	<input type="radio"/>
Via Motion controller (SSCNET III)		/	/	<input type="radio"/>	/	<input type="radio"/>	/	<input type="radio"/>	/	
Setup	System setting	<input type="radio"/>	<input type="radio"/>	<input type="radio"/>	<input type="radio"/>	<input type="radio"/>	<input type="radio"/>	<input type="radio"/>	<input type="radio"/>	<input type="radio"/>
	Automatic demo	<input type="radio"/>	<input type="radio"/>	/	<input type="radio"/>	/	<input type="radio"/>	/	<input type="radio"/>	<input type="radio"/>
Monitor	Display all	<input type="radio"/>	<input type="radio"/>	<input type="radio"/>	<input type="radio"/>	<input type="radio"/>	<input type="radio"/>	<input type="radio"/>	<input type="radio"/>	<input type="radio"/>
	Multi-axis display all	/	/	<input type="radio"/>	/	<input type="radio"/>	/	<input type="radio"/>	/	<input type="radio"/>
	Input/Output I/F display	<input type="radio"/>	<input type="radio"/>	<input type="radio"/>	<input type="radio"/>	<input type="radio"/>	<input type="radio"/>	<input type="radio"/>	<input type="radio"/>	<input type="radio"/>
	Option unit I/F display	/	/	/	/	/	/	/	/	<input type="radio"/>
	High speed monitor	<input type="radio"/>	<input type="radio"/>	<input type="radio"/>	<input type="radio"/>	<input type="radio"/>	<input type="radio"/>	<input type="radio"/>	<input type="radio"/>	<input type="radio"/>
	Trend graph	<input type="radio"/>	<input type="radio"/>	/	<input type="radio"/>	/	<input type="radio"/>	/	<input type="radio"/>	<input type="radio"/>
	Multi-axis graph	/	/	<input type="radio"/>	/	<input type="radio"/>	/	<input type="radio"/>	/	<input type="radio"/>
Alarm	Display	<input type="radio"/>	<input type="radio"/>	<input type="radio"/>	<input type="radio"/>	<input type="radio"/>	<input type="radio"/>	<input type="radio"/>	<input type="radio"/>	<input type="radio"/>
	History	<input type="radio"/>	<input type="radio"/>	<input type="radio"/>	<input type="radio"/>	<input type="radio"/>	<input type="radio"/>	<input type="radio"/>	<input type="radio"/>	<input type="radio"/>
	Amplifier data	<input type="radio"/>	<input type="radio"/>	<input type="radio"/>	<input type="radio"/>	<input type="radio"/>	<input type="radio"/>	<input type="radio"/>	<input type="radio"/>	<input type="radio"/>
Diagnostic	No motor rotation	<input type="radio"/>	<input type="radio"/>	<input type="radio"/>	<input type="radio"/>	<input type="radio"/>	<input type="radio"/>	<input type="radio"/>	<input type="radio"/>	<input type="radio"/>
	System information display	<input type="radio"/>	<input type="radio"/>	<input type="radio"/>	<input type="radio"/>	<input type="radio"/>	<input type="radio"/>	<input type="radio"/>	<input type="radio"/>	<input type="radio"/>
	Tuning data	<input type="radio"/>	<input type="radio"/>	<input type="radio"/>	<input type="radio"/>	<input type="radio"/>	<input type="radio"/>	<input type="radio"/>	<input type="radio"/>	<input type="radio"/>
	Absolute encoder data	<input type="radio"/>	<input type="radio"/>	<input type="radio"/>	<input type="radio"/>	<input type="radio"/>	<input type="radio"/>	<input type="radio"/>	<input type="radio"/>	<input type="radio"/>
	System configuration list display	/	/	<input type="radio"/>	/	<input type="radio"/>	/	<input type="radio"/>	/	<input type="radio"/>
	Axis name setting	<input type="radio"/>	<input type="radio"/>	<input type="radio"/>	<input type="radio"/>	<input type="radio"/>	<input type="radio"/>	<input type="radio"/>	<input type="radio"/>	<input type="radio"/>
	Amplifier diagnostic	<input type="radio"/>	/	/	/	/	/	/	/	/
	Fully-closed diagnostics	/	/	/	<input type="radio"/>	<input type="radio"/>	/	<input type="radio"/>	/	/
Linear diagnostics	/	/	/	/	/	<input type="radio"/>	<input type="radio"/>	/	/	
Parameters	Parameter list	<input type="radio"/>	<input type="radio"/>	<input type="radio"/>	<input type="radio"/>	<input type="radio"/>	<input type="radio"/>	<input type="radio"/>	<input type="radio"/>	<input type="radio"/>
	Multi-axis parameter setting	/	/	<input type="radio"/>	/	<input type="radio"/>	/	<input type="radio"/>	/	<input type="radio"/>
	Device setting	<input type="radio"/>	/	/	/	/	/	/	/	<input type="radio"/>
	Tuning	<input type="radio"/>	<input type="radio"/>	<input type="radio"/>	<input type="radio"/>	<input type="radio"/>	<input type="radio"/>	<input type="radio"/>	<input type="radio"/>	<input type="radio"/>
	Change list	<input type="radio"/>	<input type="radio"/>	<input type="radio"/>	<input type="radio"/>	<input type="radio"/>	<input type="radio"/>	<input type="radio"/>	<input type="radio"/>	<input type="radio"/>
	Detailed information	<input type="radio"/>	<input type="radio"/>	<input type="radio"/>	<input type="radio"/>	<input type="radio"/>	<input type="radio"/>	<input type="radio"/>	<input type="radio"/>	<input type="radio"/>
	Converter	<input type="radio"/>	/	/	/	/	/	/	/	/
	Parameter copy	<input type="radio"/>	/	/	/	/	/	/	/	<input type="radio"/>

1. INTRODUCTION

Servo amplifier		MR-J3-A	MR-J3-B		MR-J3-B-RJ006		MR-J3-B-RJ004		MR-J3-T
			When connecting to the servo amplifier	When via a motion controller	When connecting to the servo amplifier	When via a motion controller	When connecting to the servo amplifier	When via a motion controller	
Item									
Test	Jog	○	○	△	○	△	△	△	○
	Positioning	○	○	△	○	△	○	△	○
	Operation w/o motor	○	△	△	△	△	△	△	○
	Forced output	○	○	△	○	△	○	△	○
	Demo mode	○	○	△	○	△	○	△	○
	Single-step feed	△	△	△	△	△	△	△	○
Advanced-function	Machine analyzer	○	○	△	○	△	○	△	○
	Gain search	○	○	△	○	△	○	△	○
	Machine simulation	○	○	△	○	△	○	△	○
	Robust disturbance compensation	○	○	△	○	△	○	△	○
Point data	Point table	△	△	△	△	△	△	△	○
Help	MR Configuration Help	○	○	○	○	○	○	○	○
	Product information	○	○	○	○	○	○	○	○

1. INTRODUCTION

1.2 System configuration

1.2.1 Components

To use the MR Configurator, the following components are required in addition to the servo amplifier and servo motor. Configure the system according to the Installation Guide of each equipment.

Equipment		(Note 1) Description
(Note 2, 3) Personal computer	OS	IBM PC/AT compatible where the English version of Windows® 98, Windows® Me, Windows® 2000 Professional, Windows® XP Professional, Windows® XP Home Edition, Windows Vista® Home Basic, Windows Vista® Home Premium, Windows Vista® Business, Windows Vista® Ultimate, Windows Vista® Enterprise operates
	Processor	Pentium® 133MHz or more (Windows® 98, Windows® 2000 Professional) Pentium® 150MHz or more (Windows® Me) Pentium® 300MHz or more (Windows® XP Professional, Windows® XP Home Edition) 32-bit (x86) processor of 1GHz or more (Windows Vista® Home Basic, Windows Vista® Home Premium, Windows Vista® Business, Windows Vista® Ultimate, Windows Vista® Enterprise)
	Memory	24MB or more (Windows® 98) 32MB or more (Windows® Me, Windows® 2000 Professional) 128MB or more (Windows® XP Professional, Windows® XP Home Edition) 512MB or more (Windows Vista® Home Basic) 1GB or more (Windows Vista® Home Premium, Windows Vista® Business, Windows Vista® Ultimate, Windows Vista® Enterprise)
	Hard Disk	130MB or more of free space
Browser		Internet Explorer 4.0 or more
Display		One whose resolution is 800 × 600 or more and that can provide a high color (16 bit) display. Connectable with the above personal computer.
Keyboard		Connectable with the above personal computer.
Mouse		Connectable with the above personal computer.
Printer		Connectable with the above personal computer.
USB cable		MR-J3USBCBL3M
RS-422/232C conversion cable		DSV-CABV (Diatrend) is recommended.

Note 1. Windows and Windows Vista are the registered trademarks of Microsoft Corporation in the United States and other countries.

Pentium is the registered trademarks of Intel Corporation.

2. On some personal computers, this software may not run properly.
3. 64-bit Windows XP and 64-bit Windows Vista are not supported.

1. INTRODUCTION

1.2.2 Configuration

(1) For use of USB

Run/operate the servo amplifier of axis 1. As the USB cable, use the optional MR-J3USBCBL3M.

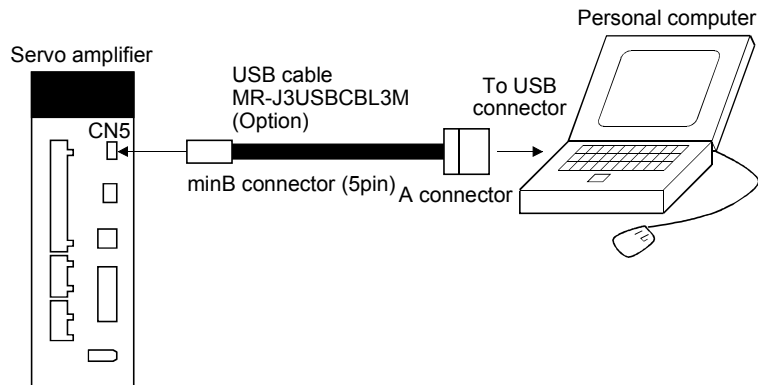

(2) For use of RS-422 (MR-J3-A • MR-J3-T)

Run/operate the servo amplifier of axis 1. It is recommended to use the following cable.

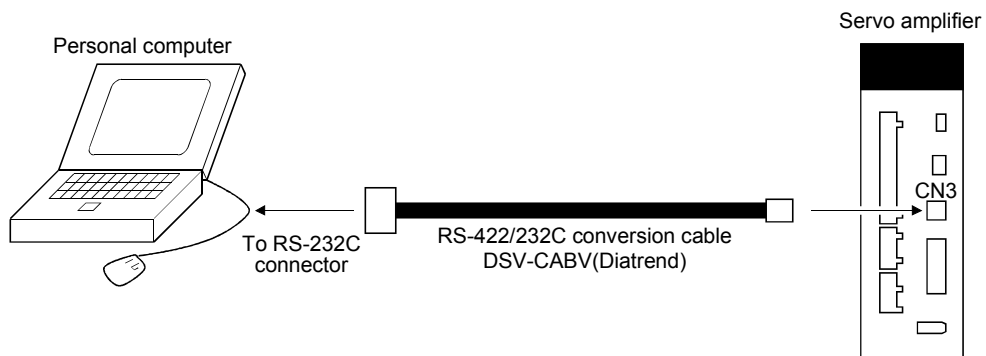

1. INTRODUCTION

(3) For setting up via a motion controller (MR-J3-B)

Control several servo amplifiers via a motion controller.

(a) When establishing USB connection

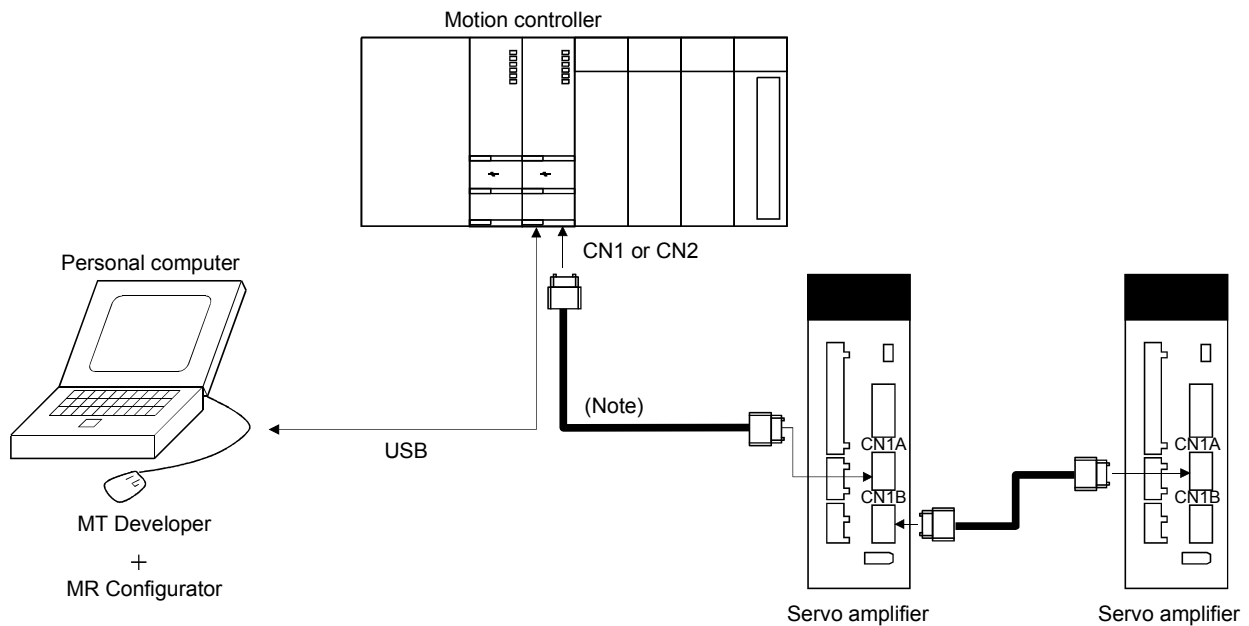

Note. Q173HCPU: 2 systems (max. 32 axes), Q172HCPU: 1 system (max. 8 axes)

(b) When selecting the MT Communication setting

Communication is performed according to the communication method and communication path that are set in the communication setting on MT Developer in the following case; when clicking the "Setup" button to open the System Setting screen and then selecting the "MT Communication setting" in the pull down menu for Communication Device.

Note that it is not compatible with the SSCNET communication. When setting the SSCNET communication in the MT Developer communication setting, set the communication path to the motion controller USB connection using MR Configurator.

1. INTRODUCTION

1.3 Basic terms

1) Mouse pointer

An on-screen arrow which moves with movements of the mouse.

2) Point

To move the mouse pointer to a particular item or position on the screen.

3) Click

To press and release the left button of the mouse once.

4) Double-click

To press and release the left button of the mouse twice.

5) Drag

To hold down the left button of the mouse and move the mouse.

6) Focus

Highlights characters, button or the like when the menu or button is ready to accept an input from the keyboard.

7) Text box

Box used to enter characters.

8) List box

Box used to select one of several items.



9) Combo box

Box used to select one of several items.



10) Check box

Box used to select one or more of several items. When a choice is made a mark appears in the box.

11) Option button

Button used to select only one of several items. When a choice is changed  moves to a new choice.

1. INTRODUCTION

1.4 Installation procedure

When Windows XP Professional, Windows 2000 or Windows Vista is used, perform installation with the administrator authority (computer administrator authority).

Here, the hard disk drive of the personal computer is explained as C and the CD drive as D.

Before executing this program, be sure to close all other Windows programs.

Disconnect the USB cable when the personal computer is connected with the servo amplifier by the USB cable.

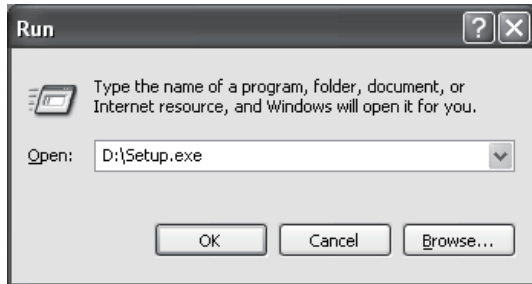

- 1) Insert the CD-ROM in Drive D (CD drive). Then, click the "Start" button on the task bar to open the menu, and click "RUN". When the left window as shown on the left appeared, type "D:\Setup.exe" and click the "OK" button.

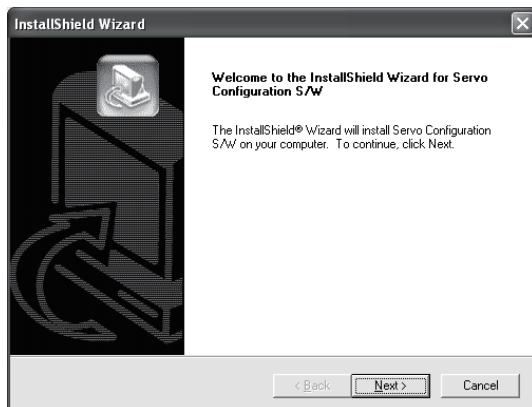

- 2) After the above window, the left window appears. Click the "Next" button.



- 3) The Installation flow screen appears. Click the "Next" button.



- 4) After the Setup status screen, the User information screen appears. Enter the user name and company name, and click the "Next" button.

1. INTRODUCTION



5) The Input product ID screen appears. Enter the product ID on the software registration form provided with the product in single-byte alphanumeric characters, and click the "Next" button.

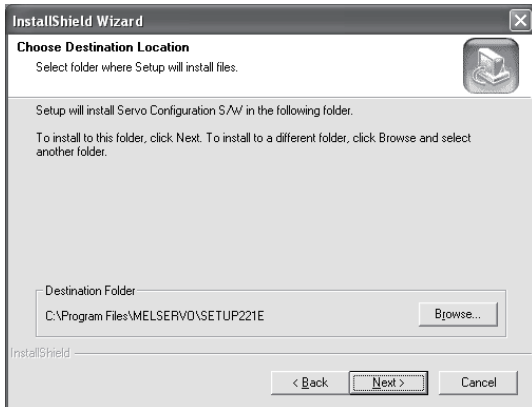

6) The Select installation destination screen appears. Specify the installation destination, and click the "Next" button. This starts installation.

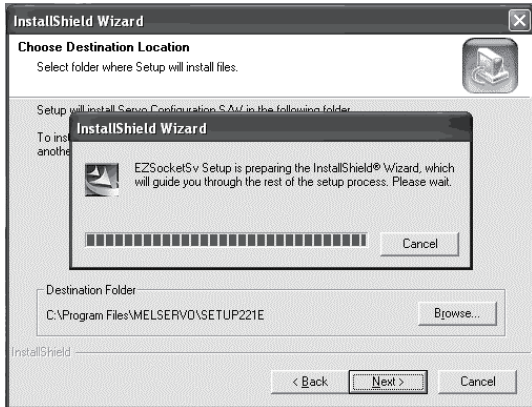

7) The driver installation window appears.

POINT

- When Windows XP is used, the verify screen appears. Click the "Continue Anyway" button.

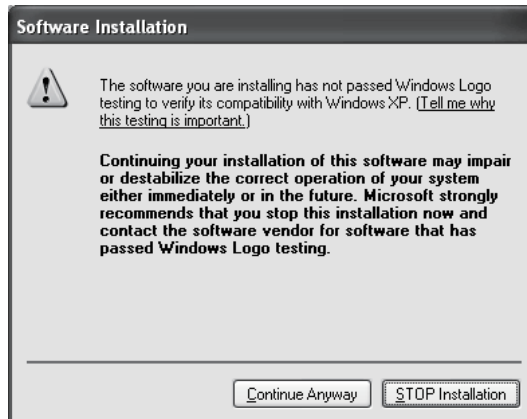

1. INTRODUCTION

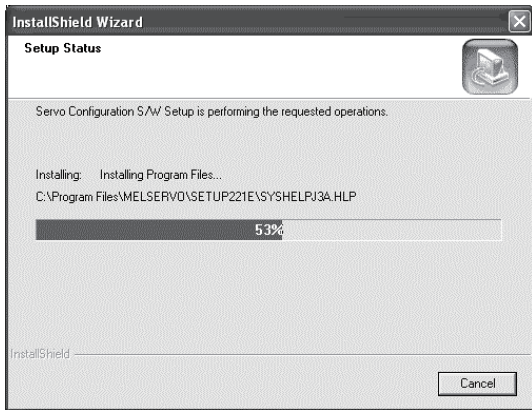

8) The Setup status screen appears.

POINT

- On Windows Vista, the security warning screen shown below appears three times. Select "Install this driver software anyway" for all three times. (The screen does not appear after the USB driver is registered.)

Click

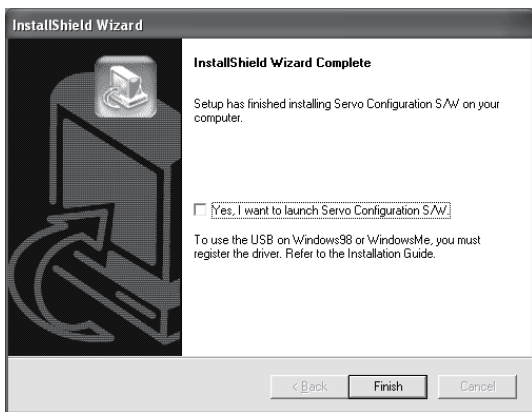

9) When installation is completed, the next screen appears. Click the "Finish" button to end the setup.

POINT

- In the corresponding window, to stop installation, click the "Cancel" button or press the "Escape".

1. INTRODUCTION

1.5 New Hardware Detection Wizard

The New Hardware Adding Wizard appears when the servo amplifier powered on is connected with the personal computer via USB for the first time. (Only when Windows 98, Windows Me or Windows XP is used) New hardware is automatically detected when Windows 2000 or Windows Vista is used. The following shows a display flow.

(1) When Windows 98 or Windows Me is used

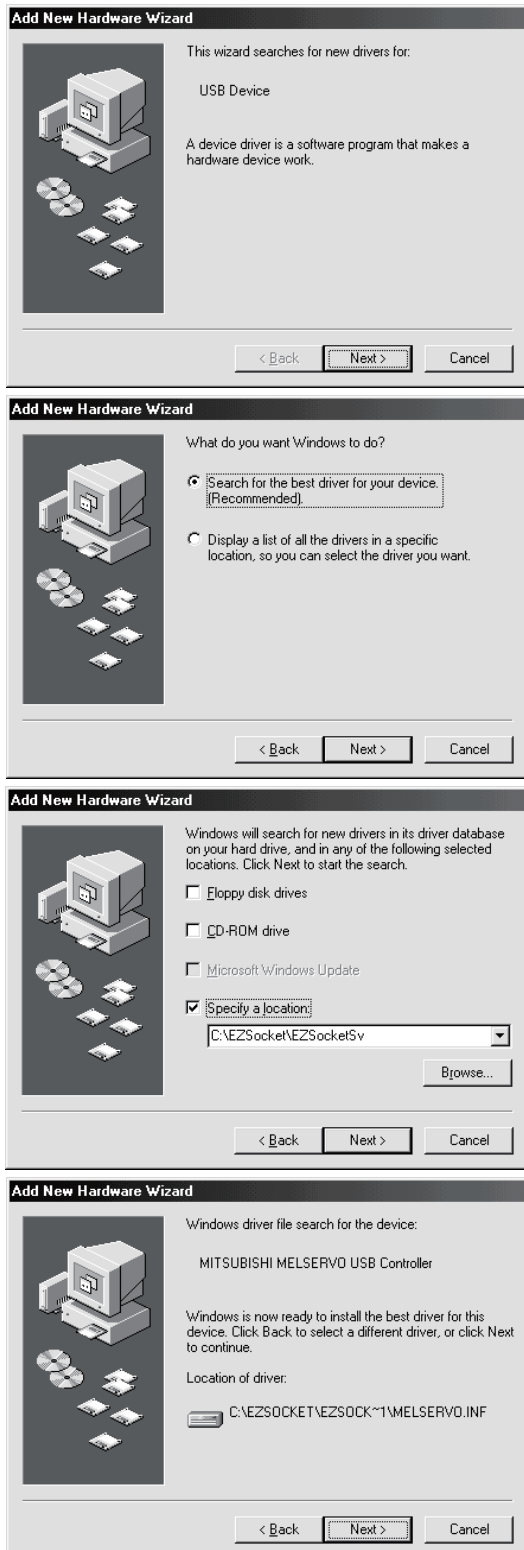

Click "Next".

Specify "Search for the best driver for your device. (Recommended)".
Click "Next".

Check "Specify a location", and specify "C:\EZSocket\EZSocketSv".
Click "Next".

Click "Next".

1. INTRODUCTION



Click "Finish".

(2) When Windows XP is used



Click "Next".



Click "Continue Anyway".

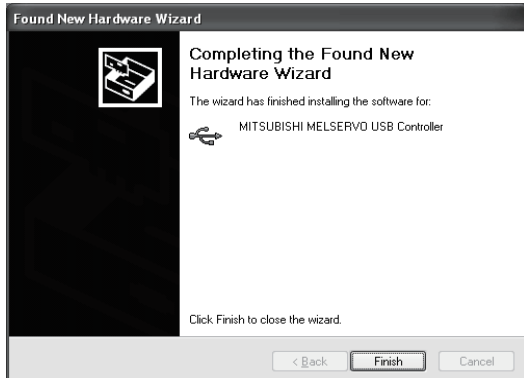

Click "Finish".

1. INTRODUCTION

(3) Windows 2000

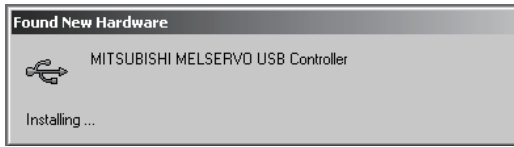

Indications on the left appear during automatic registration.
(Operation is not required.)



(4) Windows Vista

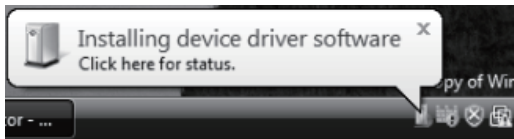

Indications on the left appear during automatic registration.
(Operation is not required.)



2. HOW TO USE THE SOFTWARE

2. HOW TO USE THE SOFTWARE

2.1 Operation

The method of selecting the command is the operation procedures using the mouse.
Unavailable commands are grayed out.

2.1.1 Start-up

(1) When connecting to the servo amplifier

- 1) Click the "Start" button of the task bar to open the menu.
- 2) Point to submenu "All Program", "MR Configurator" from "MELSOFT Application".
- 3) Click "SETUP221E".

(2) When operating via a motion controller

Click the "Servo Setup" in the motion controller integrated setup support software MR Developer.

2.1.2 Project

(1) Creating a new project

Clicking "Project" on the menu bar displays the following menu.

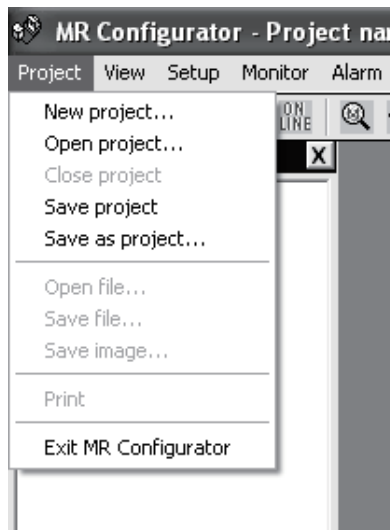

Clicking "New project" in the sub menu displays the following window.

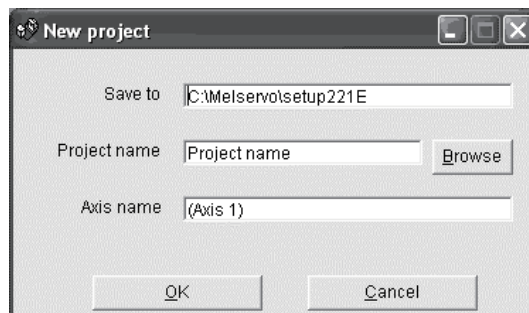

2. HOW TO USE THE SOFTWARE

Enter the save destination, project name and axis name, and click the "OK" button. This displays the following window. All input information is initialized to the default values. The default values can be changed.

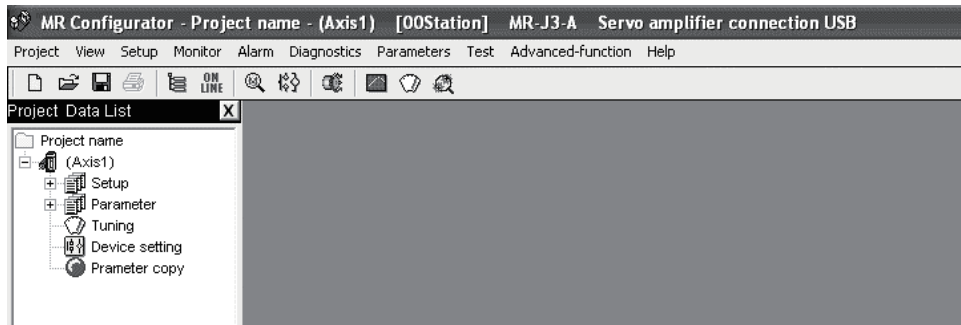

(2) Opening the project

Read the input information from the saved file.

Clicking "Open project" in the sub menu opens a window, where you can specify the project to be read.

(3) Closing the project

Close the currently open project.

Clicking "Close project" in the sub menu closes the project.

(4) Saving the project

Modify and save the currently open project.

Clicking "Save as project" in the sub menu saves the project.

(5) Saving the project with name

Save the current input information into a file. If the information to be repeatedly input is saved, that information can be read by clicking "Open project".

Clicking "Save as project" in the sub menu displays the following window.

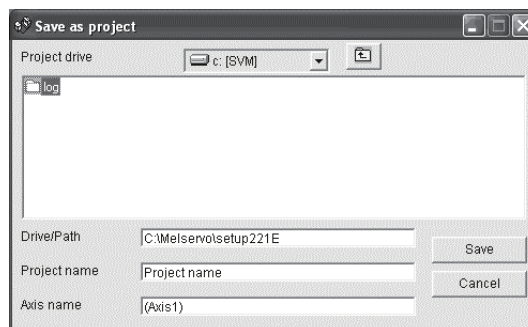

Enter the drive/path, project name and axis name, and click the "Save" button.

2. HOW TO USE THE SOFTWARE

2.2 Commands and display windows

This section provides commands and their main descriptions.

For the method of using each command, the detailed explanation is provided in the help function of the servo amplifier software.

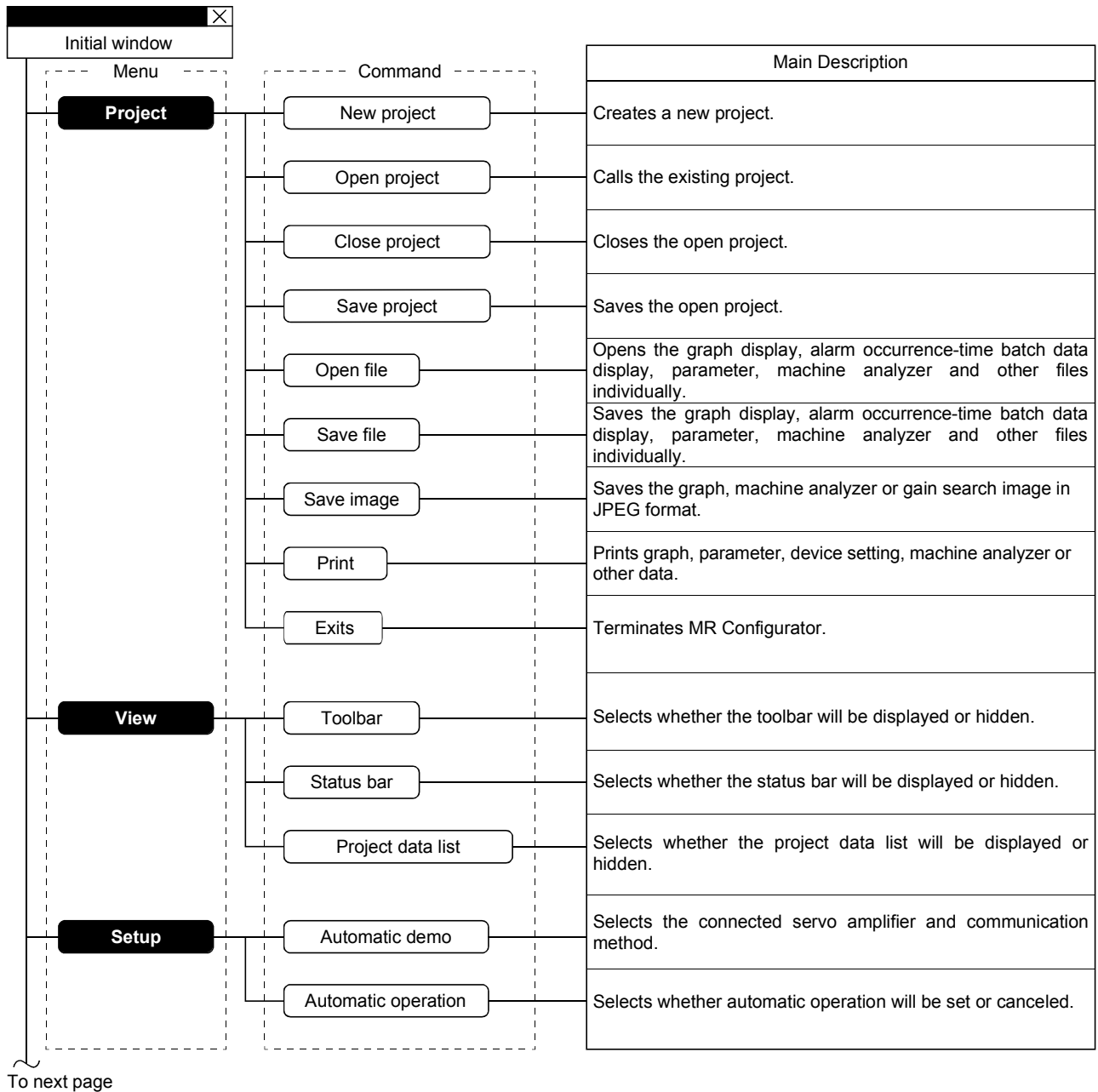

2. HOW TO USE THE SOFTWARE

Continued from previous page

Menu	Command	Main Description
Monitor	Display all	Displays the servo status item-by-item numerically.
	Multi-axis display all	Displays the servo amplifier status on several axes item-by-item numerically.
	Input/Output I/F display	Displays the I/O signal, analog monitor and other statuses. The I/O devices can be changed.
	Option unit I/F display	Displays the I/O signal of the option unit and analog monitor statuses. The I/O devices can also be changed.
	High speed monitor	Displays the statuses of a maximum of four items fast numerically.
	Trend graph	Displays the servo status in graphical form.
	Multi-axis graph	Becomes valid only when a motion controller is midway along the path.
Alarm	Display	Displays the current alarms and their occurrence factors.
	History	Displays the alarm history.
	Amplifier data	Displays the statuses at alarm occurrence.
Diagnostic	No motor rotation	Displays the reason why the servo motor does not rotate.
	System information display	Displays the model names and other information of the servo amplifier and servo motor.
	Tuning data	Displays the servo gains adjusted by auto tuning.
	Absolute encoder data	Displays the ABS data.
	System configuration list display	Displays information on the axis such as its name, type, and status.
	Axis name setting	Sets the axis name.
	Amplifier diagnostic	Self-diagnoses the servo amplifier.
	Fully-closed diagnostics	Displays the monitor and parameters concerning the fully-closed function.
	Linear diagnostics	Displays the monitor and parameters concerning the linear function.
Parameters	Parameter list	Sets the parameters.
	Multi-axis parameter setting	Sets the parameter for several axes.
	Device setting	Changes the input device.
	Tuning	Sets/adjusts the gain parameters.
	Change list	Displays a list of parameters that have been changed from their default values.
	Detailed information	Checks the parameter details.
	Converter	Converts the parameter file of the MR-J2S-A servo amplifier into the parameter file format of the MR-J3-A. Some parameters cannot be converted.
	Parameter copy	Reads the parameter values from one servo amplifier and forcibly writes them to another servo amplifier. Available when copying the parameter values to multiple servo amplifiers.

To next page

2. HOW TO USE THE SOFTWARE

Continued from previous page

Menu		Command		Main Description
Test	Jog			Executes JOG operation.
	Positioning			Executes positioning operation.
	Operation w/o motor			Executes motorless operation.
	Forced output			Executes DO forced output.
	Demo mode			Executes programmed operation.
	Single-step feed			Operates according to the point table.
Advanced-function	Machine analyzer			Executes machine analyzer.
	Gain search			Executes gain search.
	Machine simulation			Executes machine simulation.
	Robust disturbance compensation			Sets the parameter of robust disturbance compensation.
Point-data	Point table			Sets the point table.
Help	MR Configurator help			Displays Help of MR Configurator.
	Product information			Displays version information.

2. HOW TO USE THE SOFTWARE

2.3 Precautions for test mode

⚠ WARNING

- Always touch the switches with dry hands. You may get an electric shock if you touch them with wet hands.
- Always operate the equipment with the front cover installed. Removing the front cover will expose the terminals and charged area having high voltages, which may lead to an electric shock.
- Keep the front cover closed while power is on the equipment is running. Otherwise, you may get an electric shock.

⚠ CAUTION

- Before starting operation, make sure that the parameters are set to correct values. Depending on machines, they may operate unpredictably.
- Take safety measures, e.g. provide covers, to prevent accidental contact of hands and parts (cables, etc.) with the servo amplifier heat sink, regenerative brake resistor, servo motor, etc. since they may be hot while power is on or for some time after power-off. Their temperatures may be high and you may get burnt or a parts may damaged.

(1) Servo on

In the Jog, Positioning, Demo Mode or Single-step Feed available in the Test, the servo amplifier's digital input signal SON is automatically switched on in the servo amplifier to start operation, independently of the ON/OFF status of SON. Also, any external command pulse or input signal (except emergency stop) is not accepted until the test mode window is closed to terminate the command.

SON is automatically switched on by the following operation:

Test mode	Mouse
Jog	Click the "Forward" or "Reverse" button.
Positioning	
Demo Mode	Click the "Start" button.
Single-step feed	Selects the single-step feed of menu.

(2) Stop

POINT

- To make an emergency stop, switch off the emergency stop signal of the servo amplifier or shut off the input power.

1) Perform the following operation to stop the test mode:

Test mode	Mouse
Jog	When the check box for "Rotation only while the button is being pushed" on the JOG operation window is not checked, click the "Stop" button. When the check box is checked, release the "Forward" and "Reverse" buttons.
Positioning	Click the "Pause" button.
Demo Mode	Click the "Reset" button.
Single-step feed	Click the "Pause" button.

2. HOW TO USE THE SOFTWARE

2) The servo motor will stop if either of the following situations occurs in the test mode:

- The communication cable is disconnected.
- If the window is dragged or the other menu is opened, communication between the personal computer and the servo amplifier may be suspended temporarily, stopping the servo motor temporarily.
- Forced software stop is made.

2. HOW TO USE THE SOFTWARE

2.4 Simple language for program operation

The language used in the program operation-edit window will be described below.

2.4.1 Language

The chart below describes the commands in the program operation-edit window to execute the program operation mode, in which the MR-J3-□ goes into the position control mode.

Describe a program in upper case characters and Enter or Return at the end of a line. Up to 300 lines may be described.

Command	Name	Setting (**: Set value)	Setting range	Unit	Description																												
SPN	Feedrate	SPN (**)	0 to permissible instantaneous speed	r/min	Used to set the command speed given to the servo motor for positioning. The set value should be not more than the permissible speed of the servo motor used.																												
STC	Acceleration/deceleration time	STC (**)	0 to 50000	ms	Used to set the acceleration/deceleration time. (Time required to reach the rated speed of the corresponding servo motor)																												
MOV	Move command	MOV (**)	-9999999 to 9999999	pulse	Used to execute movement by the preset pulses. Positioning operation is performed with the set values of the feedrate (SPN) and acceleration /deceleration time (STC). No symbol: CCW rotation, -: CW rotation																												
SYNC	Waiting external signal to switch on	SYNC (**)	As listed in the table at right.		<p>Available on MR-J3-A * MR-J3-T.</p> <p>Used to hold the next operation until the preset digital input signal (DI) of the servo amplifier switches on. By setting 99, the next operation will be performed unconditionally. Set the input signal as listed below:</p> <p>For the MR-J3-A, the signal not assigned in signal assignment in the position control mode of parameter PD03 to PD8/PD10 to PD12 is invalid if selected here.</p> <p>For the MR-J3-T, the CC-Link or the external input signal of the CN6 connector is used as an input device. The CN6 connector must be assigned from parameter PD06 to PD08.</p> <table border="1" data-bbox="922 1355 1406 1794"> <thead> <tr> <th>Set Value</th> <th>MR-J3-A</th> </tr> </thead> <tbody> <tr><td>0</td><td>SON</td></tr> <tr><td>1</td><td>LSP</td></tr> <tr><td>2</td><td>LSN</td></tr> <tr><td>3</td><td>TL</td></tr> <tr><td>4</td><td></td></tr> <tr><td>5</td><td>PC</td></tr> <tr><td>6</td><td>RES</td></tr> <tr><td>7</td><td>CR</td></tr> <tr><td>8</td><td></td></tr> <tr><td>9</td><td></td></tr> <tr><td>10</td><td></td></tr> <tr><td>11</td><td></td></tr> <tr><td>99</td><td>Unconditional</td></tr> </tbody> </table>	Set Value	MR-J3-A	0	SON	1	LSP	2	LSN	3	TL	4		5	PC	6	RES	7	CR	8		9		10		11		99	Unconditional
Set Value	MR-J3-A																																
0	SON																																
1	LSP																																
2	LSN																																
3	TL																																
4																																	
5	PC																																
6	RES																																
7	CR																																
8																																	
9																																	
10																																	
11																																	
99	Unconditional																																
TIM	Dwell command time	TIM (**)	1 to 50	s	Used to hold the next operation until the preset time elapses.																												
TIMES	Program count command	TIMES (**)	1 to 99	Times	Used to specify the number of cycles or times (from TIMES to STOP) that the positioning is to be repeated. Enter the TIMES (**)																												
STOP	Program stop				Used to stop the program being executed. Need not be described on the last line.																												

2. HOW TO USE THE SOFTWARE

2.4.2 Program example

As soon as the "Start" button is clicked, SON is switched on automatically to start operation.

Timing chart

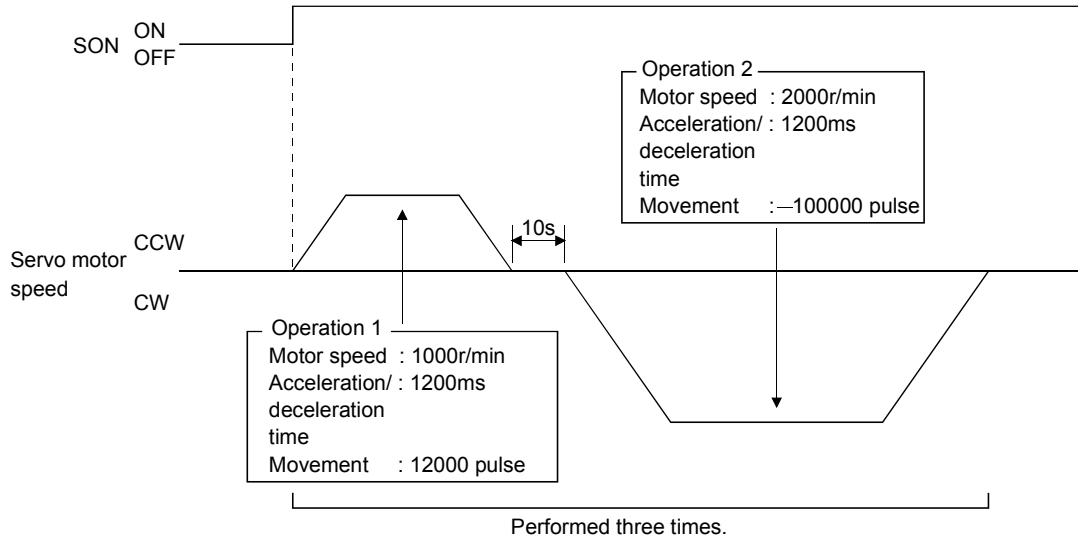

Program

TIMES (3)	Repeats the program up to STOP three times.	
SYNC (0)	Holds the program from running until the input signal with the set value of 0 (SON) switches on.	
SPN (1000)	Sets the command speed to 1000r/min.	} Operation 1
STC (1200)	Sets the acceleration/deceleration time to 1200ms.	
MOV (12000)	Executes movement by 12000 pulses in the CCW direction.	
TIM (10)	Hold the next operation for 10s.	} Operation 2
SPN (2000)	Sets the command speed to 2000r/min.	
MOV (-100000)	Executes movement by 100000 pulses in the CW direction.	
STOP		

In this example, the acceleration/deceleration time in Operations 1 and 2 are the same.

In this case, the acceleration/deceleration time in Operation 2 need not be set. In this way, set values different from those in the preceding operation need only be described in the operation program.

2.4.3 Instruction

When the program operation mode is executed with the program operation mode window and another window (Amplifier Data Display window) being displayed at the same time, the program may progress slower, making the dwell command time longer than the set value.

3. TROUBLESHOOTING

3. TROUBLESHOOTING

(1) Communication error

If communication between the personal computer and the servo amplifier is suspended and the communication error as shown in the following window occurs, check the code on the right of the error message and remove its cause.

<Possible cause> Poor connection of communication cable, system setting mistake, noise entry, hard disk fault, wiring fault, etc.

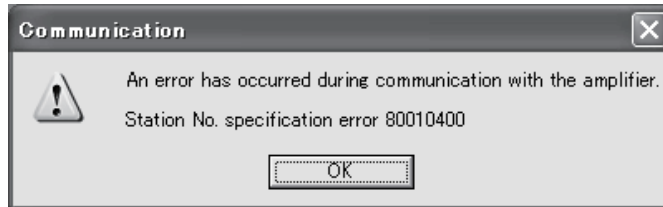

*****001	Communication error
*****002	Communication timeout error
80A00107	
*****009	Insufficient memory error
80010400	Station No. specification error
80010200	Communication port specification error
80070100	Write protect parameter
80080200	The RD signal cannot be turn ON
Other number	MR Configurator error

(2) If driver has been installed, driver installation screen appears at USB connection.

When Windows 2000 or Windows XP is used, the driver must be installed for each USB port. When the servo amplifier is connected to a different USB port for the first time, the driver installation screen appears.

(3) Time-out error occurs at return from standby mode

POINT
<ul style="list-style-type: none"> ▪ Some personal computers cannot return to normal from a system standby. In this case, make the system standby of the personal computer invalid.

When a system standby has been set in the power option or power saving mode of a notebook PC, a time-out error will occur at a return from a system standby.

3. TROUBLESHOOTING

(4) Communication can never be made if USB is connected

The driver may not be set correctly. Check whether the USB driver is set correctly on the Device manager screen and whether "MITSUBISHI MELSERVO USB Controller" is displayed under the "Universal Serial Bus controllers" folder on the Device manager screen with the servo amplifier powered on. If "? USB Device" is displayed, delete the driver once, then power the servo amplifier off and then on, and reinstall the driver.

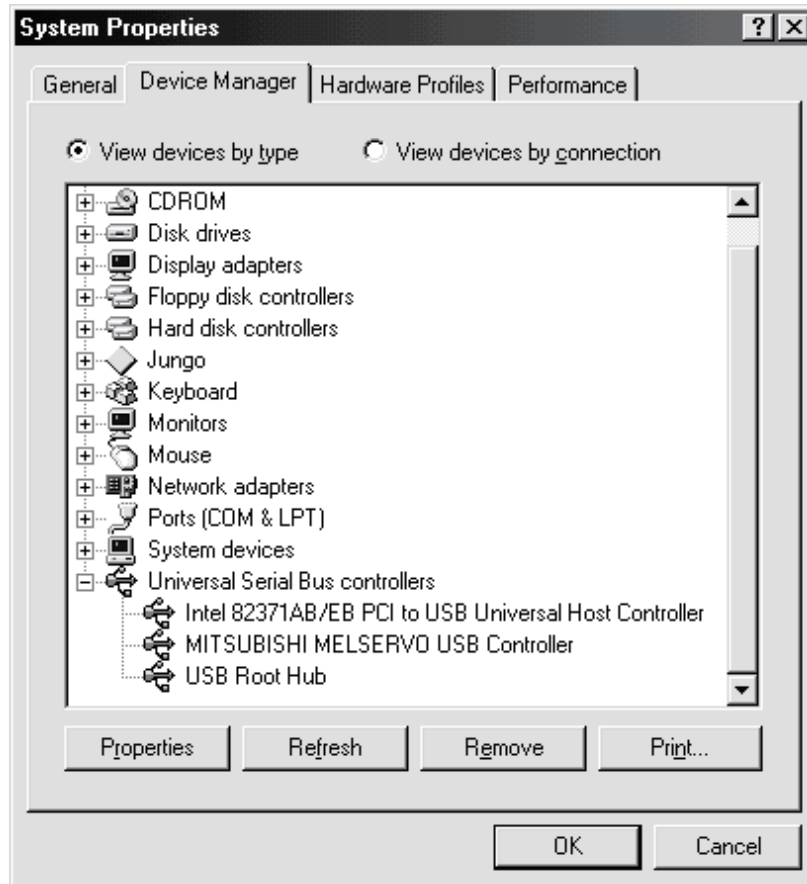

Set the Device manager screen in any of the following methods.

(a) When Windows 98 is used

Click the "Start" button on the task bar to open the menu. Point to "Settings" and point to "Control Panel".

Click "System" to open System Properties, and click the "Device Manager" tag.

(b) When Windows Me is used

Click My Computer, right-click, and click "Property". Open System Properties and click the "Device Manager" tag.

(c) When Windows 2000 is used

Click My Computer, right-click, and click "Property". Open System Properties, click the "Hardware" tag, and click "Device Manager".

(d) When Windows XP is used

Click the "Start" button on the task bar to open the menu. Click "My Computer" to open the My Computer screen, and click "View system information" to open "System properties". Click the "Hardware" tag, and click "Device Manager".

3. TROUBLESHOOTING

(e) When Windows Vista is used

Click the "Start" button on the task bar to open the menu. Right-click "Computer" and then click "Property". Open "System properties" and then click "Device Manager".

REVISIONS

*The manual number is given on the bottom left of the back cover.

Print Data	*Manual Number	Revision
Feb., 2004	IB(NA)0300082-A	First edition
Apr., 2005	IB(NA)0300082-B	<p>The servo amplifier MR-J3-B added</p> <p>Section 1.1 Communication via a motion controller (SSCNETⅢ) The multi-axis display all added The multi-axis graph added The system configuration list display added The multiple-axis parameter added</p> <p>Section 1.2.1 Second Edition erased</p> <p>Section 1.2.2 (3) Added</p> <p>Section 1.4 8) The screen modified</p> <p>Section 1.5 The word SE in Window98SE erased</p> <p>Section 2.1.1 (2) Added</p> <p>Section 2.1.2 (5) The screen modified</p> <p>Section 2.2 The multi-axis display all added The multi-axis graph added The system configuration list display added The multiple-axis parameter added</p> <p>Section 2.4.1 New sentences added to the description of SYNC</p>
May., 2006	IB(NA)0300082-C	<p>The servo amplifier MR-J3-B-RJ006 · MR-J3-B-RJ004 · MR-J3-T added.</p> <p>Section 1.1 Fully-closed diagnostics added Linear diagnostics added Single-step feed added Point data added</p> <p>Section 2.2 Fully-closed diagnostics added Linear diagnostics added Demo mode added Point data added</p> <p>Section 2.3 Single-step feed added</p>
Aug., 2007	IB(NA)0300082-D	<p>Section 1.1 Item "Option unit I/F display" added</p> <p>Section 2.2 Command "Option unit I/F display" added</p> <p>Chapter 3 (1) Communication error in the table changed</p>
Jul., 2008	IB(NA)0300082-E	<p>Windows Vista supported</p> <p>Section 1.2.1 "RS422/232C converter" deleted from components table</p> <p>Section 1.2.2 (2) RS422/232C communication converter (FA-T-RS40VS) deleted from figure, "Interface cable" changed to "RS422/232C conversion cable"</p> <p>Section 1.4 8) changed to POINT (9), 10) changed to 8), 9)) POINT added after 8)</p> <p>Section 1.5 (3) and (4) added</p> <p>Section 2.3 (2) 1) Stopping operation for JOG operation using the mouse changed</p> <p>Chapter 3 (4) (e) added</p>

MODEL	
MODEL CODE	



HEAD OFFICE : TOKYO BLDG MARUNOUCHI TOKYO 100-8310